

# MFBW1V1005

## Multilayer chip ferrite bead



### Product features

- 0402 (1005 metric) package
- High impedance values
- Multilayer monolithic construction yields high reliability
- Impedance range from 0  $\Omega$  to 1000  $\Omega$

### Applications

- Industrial connectivity (IoT)
- Wireless communications
- Bluetooth
- WiFi
- Antenna
- Machine-to-machine (M2M)
- Mobile phones
- Wearable devices
- Wireless LAN
- Computing/gaming consoles
- Broadband components
- RF transceiver modules

### Environmental compliance and general specifications

- Operating temperature range: -40 °C to +85 °C (ambient plus self-temperature rise)



**Product specifications**

Part number <sup>3</sup>	Impedance tolerance	Impedance (Ω)	DCR (Ω) maximum @ +25 °C	Test frequency <sup>1</sup> (MHz)	Test voltage <sup>1</sup> (mV)	Rated I <sup>2</sup> (mA) maximum
MFBW1V1005-000-R	0~15 Ω	0	0.04	100	50	800
MFBW1V1005-050-R	0~15 Ω	5	0.04	100	50	800
MFBW1V1005-070-R	0~11 Ω	7	0.04	100	50	800
MFBW1V1005-090-R	5~13 Ω	9	0.04	100	50	800
MFBW1V1005-110-R	7~15 Ω	11	0.04	100	50	800
MFBW1V1005-150-R	9~21 Ω	15	0.04	100	50	800
MFBW1V1005-190-R	12~25 Ω	19	0.06	100	50	700
MFBW1V1005-260-R	±25%	26	0.06	100	50	700
MFBW1V1005-310-R	±25%	31	0.08	100	50	700
MFBW1V1005-360-R	±25%	36	0.15	100	50	600
MFBW1V1005-500-R	±25%	50	0.15	100	50	600
MFBW1V1005-600-R	±25%	60	0.15	100	50	600
MFBW1V1005-700-R	±25%	70	0.20	100	50	450
MFBW1V1005-750-R	±25%	75	0.20	100	50	450
MFBW1V1005-800-R	±25%	80	0.20	100	50	450
MFBW1V1005-101-R	±25%	100	0.20	100	50	450
MFBW1V1005-121-R	±25%	120	0.25	100	50	450
MFBW1V1005-151-R	±25%	150	0.25	100	50	450
MFBW1V1005-181-R	±25%	180	0.40	100	50	450
MFBW1V1005-201-R	±25%	200	0.40	100	50	300
MFBW1V1005-221-R	±25%	220	0.40	100	50	300
MFBW1V1005-301-R	±25%	300	0.50	100	50	300
MFBW1V1005-501-R	±25%	500	0.65	100	50	200
MFBW1V1005-601-R	±25%	600	0.70	100	50	200
MFBW1V1005-801-R	±25%	800	0.90	100	50	200
MFBW1V1005-102-R	±25%	1000	1.00	100	50	200

1. Impedance test frequency and voltage.

2. Rated I: Current rating for an approximate self-temperature rise of 40 °C or less.

3. Part number definition: MFBW1V1005-xxx-R

MFBW1V1005 = Product code and size

xxx = Impedance value in Ω, last character equals number of zeros

-R suffix = RoHS compliant

**Mechanical parameters, schematic, pad layout (mm)**



a (2plcs)

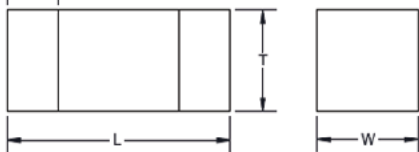

Recommended pad layout

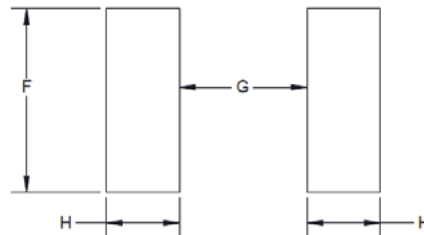

Schematic

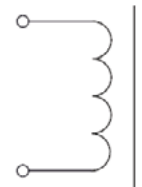

Part number	L	W	T	a	F	G	H
MFBW1V1005-xxx-R	1.0 ±0.15	0.50 ±0.15	0.50 ±0.15	0.25 ±0.1	0.90 ref	0.20 ref	0.80 ref

Part marking: No marking

All soldering surfaces to be coplanar within 0.1 millimeters

Tolerances are ±0.1 millimeters unless stated otherwise

Pad layout dimensions are reference only

Traces or vias underneath the inductor is not recommended

**Packaging information (mm)**

Drawing not to scale

Supplied in tape and reel packaging, 10000 parts per 7" diameter reel

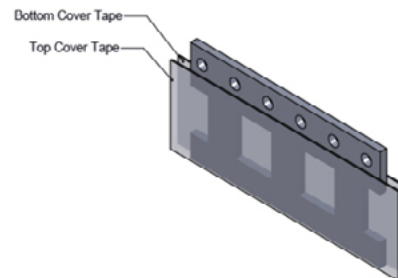
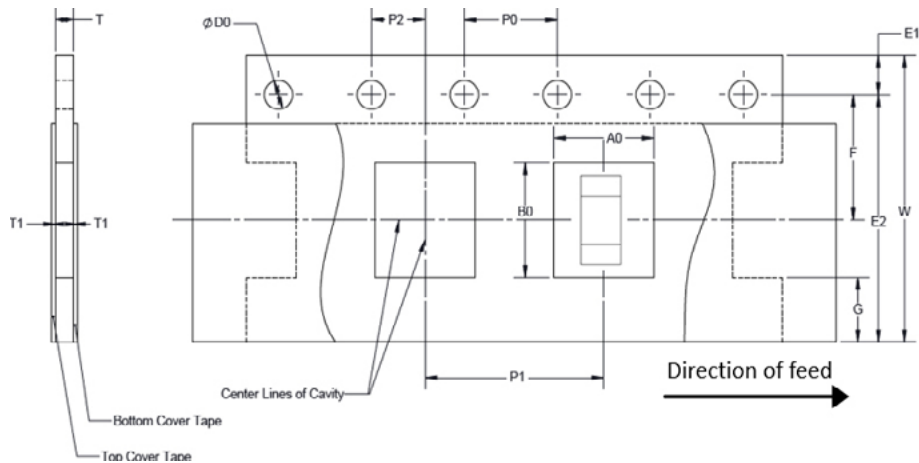

$W \pm 0.2$	8.00
$F \pm 0.1$	3.50
$E_1 \pm 0.2$	1.75
$E_2$ Min	na
$P_0 \pm 0.2$	4.00
$P_1 \pm 0.2$	2.00
$P_2 \pm 0.1$	2.00
$D_0 \pm 0.1$	1.55
$A_0$	$0.65 \pm 0.1$
$B_0$	$1.15 \pm 0.1$
$T$	$0.6 \pm 0.1$
$T_1$ Max	na

**Qualification testing**

<b>No.</b>	<b>Test item</b>	<b>Sample size (pcs)</b>	<b>Test condition</b>	<b>Acceptable value/range</b>
1	External visual	72	Specification	No physical damage
2	Physical dimension	72	Specification	Specification
3	Initial electrical test	72	Specification	User specification
4	Solderability	6	+245 °C ±5 °C, dipping 5 ±1s	>95% solder coverage
5	Resistance to soldering heat	6	+260 ±5 °C for 10 ±1 s	1. $\Delta Z/Z < \pm 30\%$ 2. No physical damage
6	Terminal strength (SMD)	6	Force of 5 N for 10 ±1 s	No physical damage No electrical performance test
7	Low temperature exposure	6	-40 °C for 1000 hours	1. $\Delta Z/Z < \pm 30\%$ 2. No physical damage
8	Bending strength	6	Appendix 2 note: 2 mm, hold time 30 s (minimum)	No physical damage No electrical performance test
9	Drop	6	Drop 10 times to a concrete floor from a height of 1 m	1. $\Delta Z/Z < \pm 30\%$ 2. No physical damage
10	Vibration	6	Amplitude modulation: 1.5 mm Test time: A period of 2 hours in each of 3 mutually perpendicular directions Test from 10 Hz to 55 Hz to 10 Hz for 1 minute	1. $\Delta Z/Z < \pm 30\%$ 2. No physical damage
11	High temperature exposure	6	+85 °C for 1000 hours	1. $\Delta Z/Z < \pm 30\%$ 2. No physical damage
12	Biased humidity	6	1000 hours +60 °C/90% to 95% RH unpowered	1. $\Delta Z/Z < \pm 30\%$ 2. No physical damage
13	Operational life	12	+85 °C at rated current for 1000 hours	1. $\Delta Z/Z < \pm 30\%$ 2. No physical damage
14	Temperature cycling	6	32 cycles (-40 °C to +85 °C), dwell time 30 minutes	1. $\Delta Z/Z < \pm 30\%$ 2. No physical damage

Impedance vs frequency

MFBW1V1005-000-R

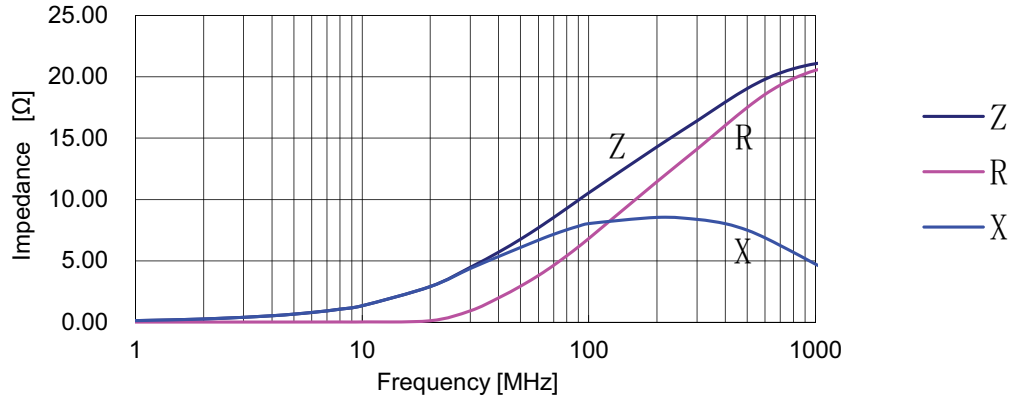

MFBW1V1005-700-R

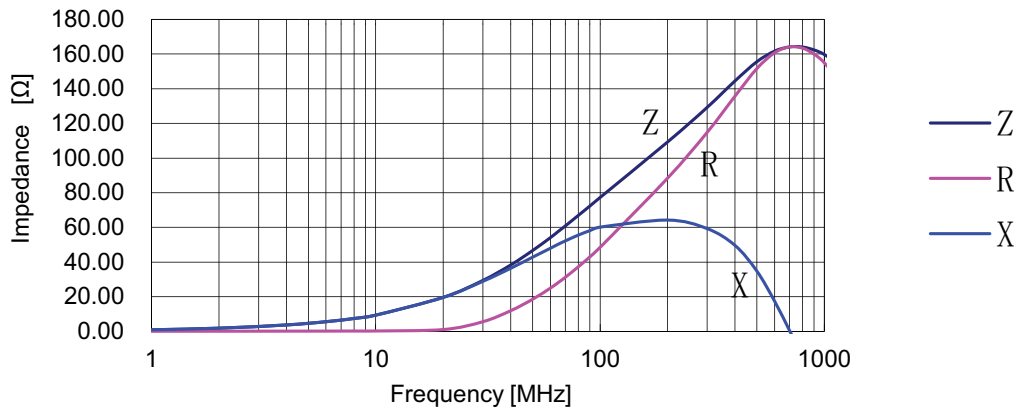

MFBW1V1005-102-R

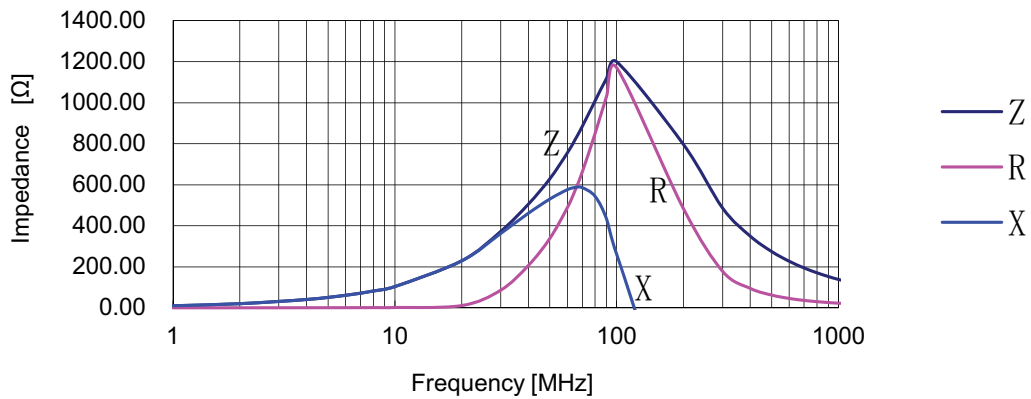

Z= impedance, R= resistance, X= reactance