



Reference Manual

Mpression MMC+ Card

Revision 1.0

2016/12/09

© 2016 Macnica, Inc.

Disclaimer

The information in this document (hereinafter called “Information”) is subject to change without notice.

Macnica Inc. (Developer) makes no warranty of any kind regarding this document, or of any liability arising out of the application or use of information in this document, and assumes no responsibility for any errors that may appear in this document.

This document is distributed without any charge and reselling or copying without written authorization by Developer is restricted.

IN NO EVENT WILL DEVELOPER BE LIABLE FOR ANY CONSEQUENTIAL, INDIRECT, EXEMPLARY, SPECIAL, OR INCIDENTAL DAMAGES, INCLUDING ANY LOST DATA AND LOST PROFITS, ARISING FROM OR RELATING TO YOUR USE OF THE INFORMATION, EVEN IF YOU HAVE BEEN ADVISED OF THE POSSIBILITY OF SUCH DAMAGES. THE TOTAL CUMULATIVE LIABILITY OF DEVELOPER IN CONNECTION WITH YOUR USE OF THE INFORMATION IN THIS DOCUMENT, WHETHER IN CONTRACT OR TORT OR OTHERWISE, WILL IN NO EVENT EXCEED THE AMOUNT OF FEES PAID BY YOU TO DEVELOPER HEREUNDER FOR USE OF THE INFORMATION. YOU ACKNOWLEDGE THAT THE FEES, IF ANY, REFLECT THE ALLOCATION OF RISK SET FORTH IN THIS AGREEMENT AND THAT DEVELOPER WOULD NOT MAKE AVAILABLE THE INFORMATION TO YOU WITHOUT THESE LIMITATIONS OF LIABILITY.

The Information is not intended for use in the development of on-line control equipment in hazardous environments requiring failsafe controls, such as in the operation of nuclear facilities, aircraft navigation or communications systems, air traffic control, life support, or weapons systems (“High-Risk Applications”). Developer specifically disclaims any express or implied warranties of fitness for such High-Risk Applications. You represent that use of the Information in such High-Risk Applications is fully at your risk.

Contents

1. Read This First	4
1.1 Important Information	4
1.2 Developer Information	5
1.3 Inquires	5
2. For Ensuring Safe Use	6
2.1 Legend	6
2.2 Cautions	6
3. Unboxing	9
4. Card Functions and Features	10
4.1 Main Features	10
4.2 Key Components	10
4.3 Block Diagram	11
4.4 Card Specifications	11
5. Components of The Card	12
5.1 Pin Assignments	12
6. Precautions During Use	13
6.1 Software Driver	13
6.2 Inserting the Card Into an MMC plus, MMC, or SD Card Slot	13
6.3 Using a Card Adapter	13
7. Application Note	14
7.1 Unmounted Components	14
7.2 Initial Factory Default Settings	14
8. Document Revision History	15

1. Read This First

1.1 Important Information

READ FIRST:

- READ** this Reference Manual before using this product.
- KEEP** the Reference Manual handy for future reference.
- Do not attempt** to use the board until you fully understand its mechanisms.

Purpose of the Product:

- This product is a memory evaluation card with on-board Micron Technology eMMC memory. It is intended for development and verification using the Mpression Sodja Board. It provides support for verification of both software and hardware.
Be sure to use this product correctly for this purpose.

For Users of This Product:

- This product should be used only by individuals who have carefully read and agreed to these materials. Use of this product requires a basic knowledge of FPGAs, MMC interfaces, logic circuits, electronic circuits, and microcomputers.

Precautions to be taken when using This Product:

- This product is to be used for development of a program, and the evaluation stage. **You cannot install the board in your product** and cannot use the board for mass-production. When mass-producing a program you have finished developing, be sure to decide at your own responsibility whether it can be put to practical use by performing integration test, evaluation, or some other experiment.
- In no event shall Macnica Inc. be liable for any consequence arising from the use of this product.
- Macnica Inc. shall make effort to provide a workaround or fix for failures of this product, with or without charge. This does not mean, however, that Macnica Inc. guarantees to provide a workaround or fix under all circumstances.
- Macnica Inc. cannot anticipate every possible circumstance that might involve a potential hazard. The warnings in this reference manual and on the product are therefore not all-inclusive. Use this product correctly and safely at your own responsibility.
- Even if a device installed on this product has a failure, it cannot be replaced.
- This product adopts the MultiMedia Plus (MMC™ plus) card type, however we have not verified connections for all equipment with an MMC or SD interface, so no guarantees are made concerning connectivity with equipment developed by you or with commercially available card adapters.
- Remodeling or damages caused by the customer is not guaranteed.
- This product is a lead-free mounting product.
- Generally, the brand names carried in this reference manual each constitute a maker's trademark or registered trademark.

Improvement Policy:

- Macnica Inc. pursues a policy of continuous improvement in design, performance, and safety of the product.
Macnica Inc. reserves the right to change, wholly or partially, specifications, design, reference manual, and other documentation at any time without notice.

Warranty:

- Macnica Inc. offers exchange of this product free of charge only in a set range of cases of initial trouble for this product, and within 30 days from when the customer received delivery of the Board.

Macnica Inc. cannot exchange products in cases where breakdown is caused for the following reasons:

- (1) Misuse, abuse of the product or use under abnormal conditions
- (2) Remodeling or repair
- (3) A fire, earthquake, fall or other accidents

Figures:

- Some figures in this reference manual may differ from your system as purchased.

1.2 Developer Information

The Developer of this product is:

Macnica Inc.

1-6-3 Shin-Yokohama, Kouhoku-ku, Yokohama, 222-8561 JAPAN

1.3 Inquires

In case you have any inquiries about the use this product, please contact your local Macnica company or make inquiries through the contact form in the following web site:

<http://www.m-pression.com/contact>



Macnica companies:

- | | | |
|------------------|-----------------------|---|
| • China & HK: | Cytech Technology | http://www.cytech.com/ |
| • ASEAN & India: | Cytech Global | http://www.cytechglobal.com/ |
| • Taiwan: | Galaxy Far East Corp. | http://www.gfec.com.tw/ |
| • North America: | Macnica Americas | http://www.macnica-na.com/ |
| • Brazil: | Macnica DHW | http://www.macnicadhw.com.br/en/ |
| • Japan: | Altima | http://www.altima.co.jp |
| | Elsena | http://www.elsena.co.jp |



2. For Ensuring Safe Use



Be sure to follow the precautions given here, which are intended to prevent harm to the user and others as well as material damage.

2.1 Legend

 Danger	Indicates an imminent hazardous situation which if not avoided will result in death or serious injury.
 Warning	Indicates a potentially hazardous situation which if not avoided could result in death or serious injury.
 Caution	Indicates a potentially hazardous situation which if not avoided may result in minor or moderate injury or in property damage.

2.2 Cautions

 Danger	<p>When an AC adapter is required, be sure to use the AC adapter included in the package or one that meets the specifications described in this Manual.</p> <p>Using an AC adapter not meeting the specifications described in this Manual may cause the kit to emit heat, explode, or ignite.</p>
 Warning	<p>Do not apply strong impacts or blows to the kit.</p> <p>Doing so may cause the kit to emit heat, explode, or ignite, or the equipment in the kit to fail or malfunction. This may also cause fire.</p>
	<p>Do not put the main unit or the AC adapter in cooking appliances such as microwave ovens, or high-pressure containers. Doing so might cause the main unit or AC adapter to emit heat, explode, ignite, or emit smoke, or its parts to break or warp.</p>
	<p>Do not wrap the main unit that is in use with cloth or other materials that are likely to allow heat to build up inside the wrapping.</p> <p>This will cause heat to build up inside the wrapping which may cause the main unit to ignite or malfunction.</p>
	<p>When disposing of the main unit, do not dispose of it along with general household waste.</p> <p>Throwing the main unit into fire may cause it to explode. Dispose of the main unit following the laws, regulations, and ordinances governing waste disposal.</p>
	<p>Do not pull the power supply cable with excessive force or place heavy items on it.</p> <p>Do not damage, break, bundle, or tamper with the power supply cable.</p> <p>Damaged parts of the power supply cable might cause a short circuit resulting in fire or accidents involving electrical shock.</p>
	<p>Do not plug or unplug the power plug with wet or moist hands.</p> <p>This might cause injuries or equipment malfunctions or failures due to electrical shock.</p>

 <p>Warning (Continued from previous page)</p>	<p>Plug the power plug securely into the outlet. If the power plug is not securely plugged into the outlet, it may cause accidents involving electrical shock or fire due to the heat that is emitted.</p> <p>Do not connect many electrical cords to a single socket or connect an AC adapter to an outlet that is not rated for the specified voltage. Doing so may cause the equipment to malfunction or fail, or lead to accidents involving electrical shock or fire due to the heat that is emitted.</p> <p>Periodically remove any dust accumulated on the power plug and around the outlet (socket). Do not use a power plug with dust accumulated on it because doing so will lead to insulation failure due to moisture which may lead to fire. Remove any dust on the power plug and around the outlet with dried cloth.</p> <p>Do not place any containers such as cups or vases filled with water or other liquid on this Board. If this Board is exposed to water or other liquids it may cause the Board to malfunction or lead to accidents involving electrical shock. If you spilled water or other liquid on this Board, immediately stop using the Board, turn off the power, and unplug the power plug. If you have any requests for repairs or technical consultation, please contact the local Macnica company or Mpression inquiry URL.</p> <p>Keep this board and accessories out of reach of children. Failure to do so may lead to injuries.</p>
 <p>Caution</p>	<p>Do not place the kit on unstable places such as shaky stands or tilted locations. Doing so may cause injuries or cause this Board to malfunction if the Board should fall.</p> <p>Do not attempt to use or leave the kit in places subject to strong direct sunlight or other places subject to high temperatures such as in cars in hot weather. Doing so might cause the kit to emit heat, break, ignite, run out of control, warp, or malfunction. Also, some parts of the equipment might emit heat causing burn injuries.</p> <p>Do not use the kit in places subject to extremely high or low temperatures or severe temperature changes. Doing so may cause the kit to fail or to malfunction. Always be sure to use the kit within a temperature range of 5°C to 35°C and a humidity range of 0% to 85%.</p> <p>Unplug the power supply cable when carrying out maintenance of devices in which the main unit is embedded. Failure to do so may lead to accidents involving electrical shock.</p> <p>Do not place the board in locations where excessive force may be applied to it. Doing so may cause the PC board to warp, leading to breakage of the PC board, missing parts or malfunctioning parts.</p> <p>When using the kit together with expansion boards or other peripheral devices, be sure to carefully read each of their manuals and to use them correctly. Developer does not guarantee the operation of specific expansion boards or peripheral devices when used in conjunction with this Board unless they are specifically mentioned in this Manual or their successful operation with this Board has been confirmed in separate documents.</p>

 <p>Caution (Continued from previous page)</p>	<p>Be sure to turn off the power switch when moving this Board to connect to other devices. Failure to do so may cause this Board to fail or lead to accidents involving electrical shock.</p>
	<p>Do not clean this Board by using a rag containing chemicals such as benzene or thinner. Failure to do so will likely to cause this Board to deteriorate. When using a chemical cloth be sure to comply with any directions or warnings.</p>
	<p>Do not immediately turn on the power if you find that water or moisture had condensed onto the main unit after removing the board from the package. Condensation might occur on this Board when taking it out of the box, if the board is cool yet the room temperature is warm. Do not apply power to the Board while water or moisture has condensed on it because the moisture may cause the Board to break or may shorten the service life of the parts.</p>
	<p>When you first take this Board out of the box be sure to leave it at room temperature for a while before using it. If condensation or moisture has occurred on this Board, first wait for the moisture to fully evaporate before installing or connecting the Board to other devices.</p>
	<p>Do not disassemble, dismantle, modify, alter, or recycle parts unless they are clearly described as customizable in this Manual. Although this kit is customizable, overall product operation cannot be guaranteed if parts needed for basic operations which are not specified in this Manual as customizable are modified in any way. Please contact the local Macnica company or Mpression inquiry URL beforehand if you wish to customize or modify any parts that are not described in this Manual as customizable.</p>
	<p>Do not touch terminals with your hands or allow them to come into contact with metal. Doing so creates the risk of corruption or loss of recorded data due to static electricity.</p>

3. Unboxing

When unpacking the product, make sure that everything is included and that nothing is damaged. If something is missing, or if you discover physical damage, contact your sales representative within 30 days after the product was delivered to you.

MMC+ Card: 1	
Circuit Diagram	Download these files from the website at the URL noted in “Packing List and Precautions”.
Reference Manual	

4. Card Functions and Features

4.1 Main Features

This card is a MultiMedia Plus (MMC plus) card type of 4GByte eMMC memory evaluation card. Inserting the card into an FPGA evaluation board that has an MMC plus card slot or SD card slot enables various types of eMMC boot and storage evaluations.

The verified FPGA evaluation board is a Macnica Mpression Sodia board with an on-board Altera Cyclone® V SoC Series FPGA.

For more detailed information and other related information, visit the link below.

- Cyclone® V Device Family Information
[Documentation: Cyclone V Devices](#)
- Mpression Sodia Board Documentation
[Sodia Board](#)

4.2 Key Components

Table 4-2-1 shows the card's product specifications.

Table 4-2-1: MMC+ Card Specifications

Key Components	MFSUSANOEMMC
External Dimensions	80 mm x 40 mm
Board Specifications	4-layer FR4
Power	DC 3.3V from MMC/SD slot
eMMC	Micron Technology MTFC4GACAJCN-1M WT
Memory capacity	4Gbyte
Operating Conditions	Temperature: 5°C to 35°C, Humidity: 0% to 85%

4.3 Block Diagram

Figure 4-3-1 shows the card block diagram.

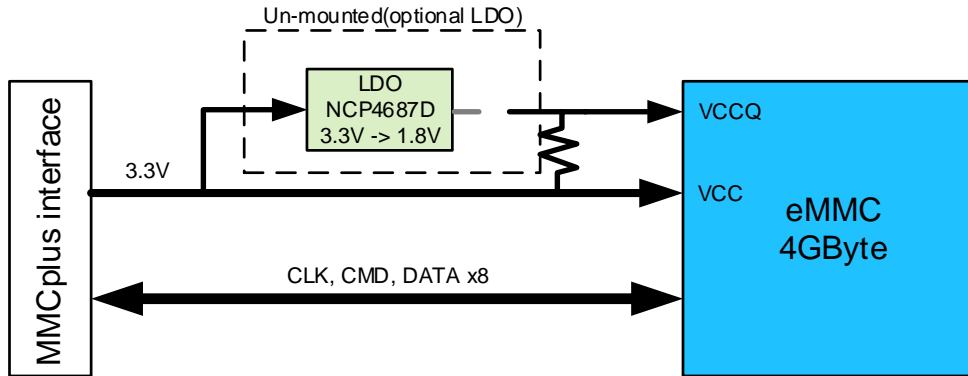

Figure 4-3-1: MMC+ Card Block Diagram

4.4 Card Specifications

Figure 4-4-1, Figure 4-4-2, and Table 4-4-1 show the card specifications.

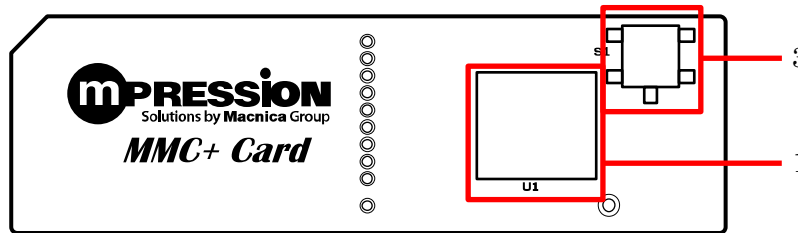

Figure 4-4-1: MMC+ Card Specification (Top View)

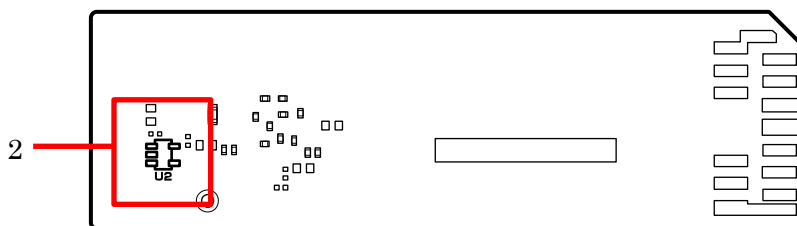

Figure 4-4-2: MMC+ Card Specification (Bottom View)

Table 4-4-1: MMC+ Card Specifications

No	Reference	Function	Description
1	U1	eMMC 4GByte	Micron Technology MTFC4GACAJCN-1M WT (JEDEC v5.0)
2	U2	LDO(3.3V -> 1.8V)	Unmounted
3	S1	Reset switch	Unmounted

5. Components of The Card

5.1 Pin Assignments

Figure 5-1-1 and Table 5-1-1 show card edge specifications.

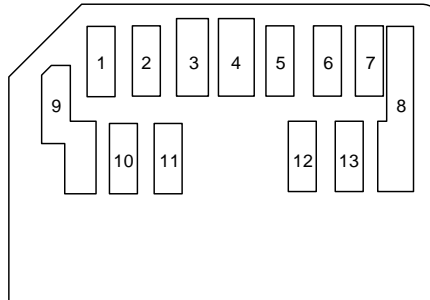

Figure 5-1-1: MMC+ Card Edge Pin Assignments (Bottom View)

Table 5-1-1: MMC+ Card Edge Pin Assignments

Pin No	Name	Function
1	DAT3	Data[3]
2	CMD	Command/Response flag
3	VSS1	GND
4	VDD	Supply voltage
5	CLK	Clock
6	VSS2	GND
7	DAT0	Data[0]
8	DAT1	Data[1]
9	DAT2	Data[2]
10-13	DAT4-7	Data[4:7]

6. Precautions During Use

6.1 Software Driver

- The eMMC on the card complies with JEDEC standards version 5.0. You should fully understand the JEDEC standards before developing drivers.
- The eMMC control method is described in the “Embedded Multi-Media Card (e•MMC) Electrical Standard (5.0) (JESD84-B50)” JEDEC standards. Obtain JEDEC documentation from the JEDEC website.
- ◇ Embedded Multi-Media Card (e•MMC) Electrical Standard (5.0) (JESD84-B50)
<http://www.jedec.org/sites/default/files/docs/JESD84-B50.pdf>
(You will need to register as a JEDEC website user (free) to download files.)
- For information about the eMMC internal register setting values, refer to the JEDEC documentation along with the Micron Technology eMMC data sheet. Obtain the data sheet from the Micron Technology website.
- Embedded Multi-Media Card (e•MMC) Electrical Standard (5.0) (JESD84-B50)
https://www.micron.com/~/media/documents/products/data-sheet/emmc/broadmarket_embedded/emmc_4gb_8gb_ps8225_v50_wt.pdf
(You will need to register as a Micron website user (free) to download files.)

6.2 Inserting the Card Into an MMC plus, MMC, or SD Card Slot

- When inserting the card into or removing it from an MMC plus, MMC, or SD Card slot on an FPGA evaluation board, be sure the card is positioned correctly and insert it into the slot securely, as far as it will go. Also, make sure that the applicable FPGA evaluation board is in a power-down state before inserting or removing the card.
- Note that inserting or removing the card while the FPGA evaluation board is in a power-up state creates the risk of device malfunction or damage.
- Take sufficient anti-static measures when handling the card. Touching the card while you hold an electrostatic charge will cause the device to malfunction or fail.

6.3 Using a Card Adapter

- When attaching the card to an adapter, make sure the card is positioned correctly and insert it into the slot securely, as far as it will go.
- Take sufficient anti-static measures when handling the card. Touching the card while you hold an electrostatic charge will cause the device to malfunction or fail.

7. Application Note

7.1 Unmounted Components

- U2 and S1 components are not mounted.
We recommend the following components if you are mounting and evaluating such components.
However, mounting these components involves modification of the product, so any operation problems following mounting are outside of the scope of the product guarantee.
- U2: VCCQ 3.3 V → 1.8 V LDO
Recommended component: ON Semiconductor LDO: NCP4687DSN18T1G
- S1 : Reset Switch
Recommended component: OMRON: B3S-1100

7.2 Initial Factory Default Settings

- The default setting of the RESET signal is OFF. To use the RESET signal, you need to change the eMMC register set value and then power back up.
 - Change RST_nFUNCTION[162] = “00h” (Default off) to “01h” (RST = ON).
CAUTION: The RST_nFUNCTION register is R/W, which means that the register value can be changed only once.
For information about how to use the RESET signal, refer to the JEDEC standards.
 - The default eMMC DATA width setting is x1-bit (DAT0 only). Register settings must be configured to change the data width to x4-bit or x8-bit.
For information about how to change the data width, refer to the JEDEC standards.
 - The default eMMC interface setting is DDR52. Though the eMMC v5.0 device itself supports up to the DDR52, HS200, and HS400 specifications, this current card does not support HS400. For information about how to change the eMMC interface specification, refer to the JEDEC standards.
 - 1.8 V or 3.3 V can be selected as the VCCQ of eMMC. The default setting is VCCQ = 3.3 V. (The JEDEC v5.0 standard covers VCCQ = 1.2 V, 1.8 V, and 3.3 V, but Micron Technology devices do not support 1.2 V.)
To use VCCQ = 1.8 V, place a 3.3 V → 1.8 V step-down LDO (Recommended: ON Semiconductor LDO: NCP4687DSN18T1G) at the card’s U2 and supply 1.8 V to the eMMC.
- * VCCQ = 3.3 V is not supported by HS200 or HS400.
- FAT32 formatting was done when checking operation on a Windows PC as part of the product test.
You must reformat the card yourself if you want to use a format other than FAT32.