

General Description

The MIC2012 is a dual channel USB power switch designed to support the power distribution requirements for USB Wakeup from the ACPI S3 state. The MIC2012 will directly switch its two outputs between a 5V main supply and a 5V auxiliary supply normally provided in ATX style power supplies.

The MIC2012 will adjust its current-limit threshold according to the ACPI state it is in. In the normal active S0 state the current-limit is set at 500mA minimum per channel satisfying the USB continuous output current specification. In the S3 state the current-limit can be reduced to only 100mA per channel to minimize the current that is supplied by the auxiliary supply thereby ensuring that voltage regulation is maintained even during fault conditions.

The MIC2012 provides make-before-break switching to ensure glitch-free transitions between the S3 and S0 states. Each channel is also thermally isolated from the other so that a fault in one channel does not effect the other. FAULT status output signals are also provided indicating overcurrent and thermal shutdown conditions.

The MIC2072 option latches the output off upon detecting an overcurrent condition for more than 5ms minimum. The output can be reset by either toggling the EN inputs of the MIC2072-1, -2 or by removing the load. Latching the output off provides a circuit breaker mode of operation which reduces power consumption during fault conditions.

Features

- Compliant to USB power distribution specifications
- UL Recognized Component
- Two completely independent switches
- Integrated switching matrix supports ACPI S0/S3 state transitions without external FET circuits
- Make-before-break switching ensures glitch-free transitions
- No back-feed of auxiliary supply onto main supply during standby mode
- Bi-level current-limit preserves auxiliary supply voltage regulation in standby mode
- Thermally isolated channels
- Thermal shutdown protection
- Fault status outputs with filter prevents false assertions during hot-plug events
- Latched thermal shutdown options with auto-reset (MIC2072)
- Undervoltage lockout

Applications

- Desktop PCs
- Notebook PCs
- Notebook Docking stations
- LAN Servers
- PC Motherboards

Typical Application

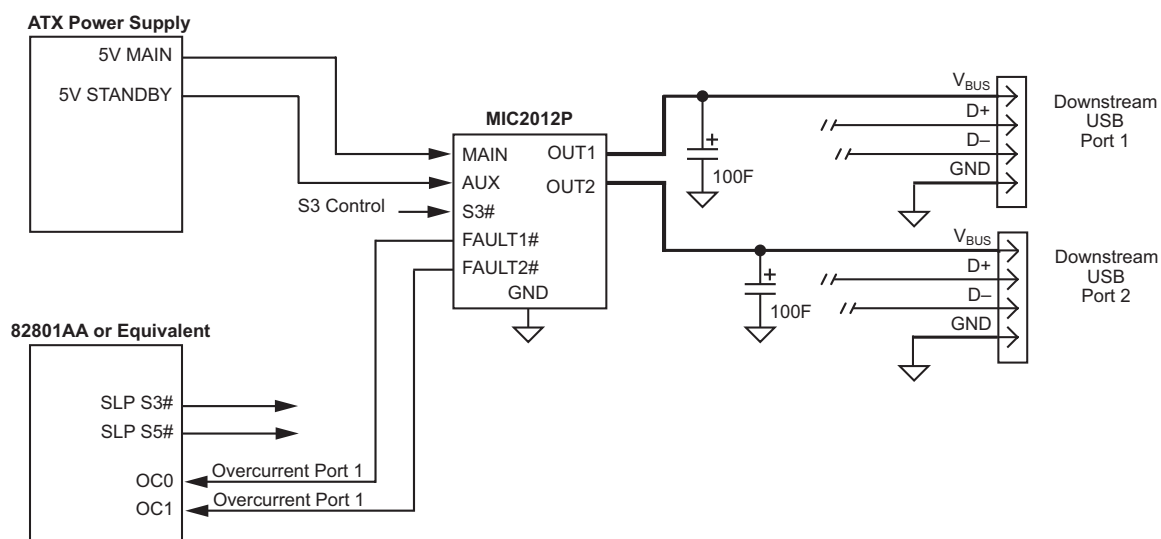

Figure 1. USB Wakeup with Control Input



UL Recognized Component

Micrel, Inc. • 2180 Fortune Drive • San Jose, CA 95131 • USA • tel + 1 (408) 944-0800 • fax + 1 (408) 474-1000 • <http://www.micrel.com>

Ordering Information

Part Number		Enable	Fault Output	Circuit Breaker Range	Temperature Range	Package
Standard	Pb-Free					
MIC2012BM ⁽¹⁾	MIC2012YM ⁽¹⁾	n/a	Open-Drain		0°C to +70°C	8-lead SOIC
MIC2012CM	MIC2012ZM	n/a	Open-Drain		0°C to +70°C	8-lead SOIC
MIC2012PCM	MIC2012PZM	n/a	Internal Pull-Up		0°C to +70°C	8-lead SOIC
MIC2012-1PCQS	MIC2012-1PZQS	Active High	Internal Pull-Up		0°C to +70°C	16-lead QSOP
MIC2012-2PCQS	MIC2012-2PZQS	Active Low	Internal Pull-Up		0°C to +70°C	16-lead QSOP
MIC2072-1PCQS	MIC2072-2PZQS	Active High	Internal Pull-Up	Δ	0°C to +70°C	16-lead QSOP
MIC2072-2PCQS	MIC2072-2PZQS	Active Low	Internal Pull-Up	Δ	0°C to +70°C	16-lead QSOP

Note:

1. Contact factory for availability

Pin Configuration

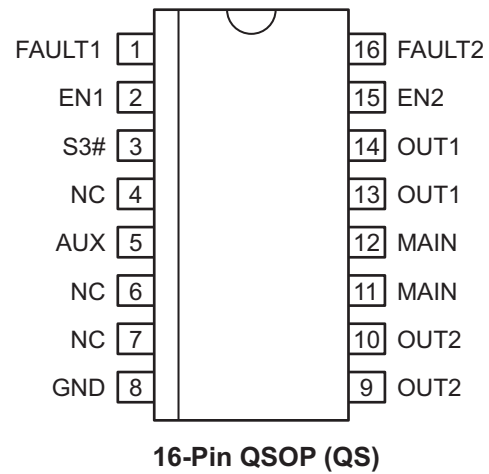
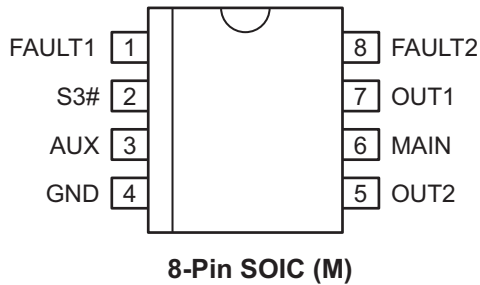

Pin Description

Pin Number (MIC2012)	Pin Number (MIC2012-1, -2)	Pin Name	Pin Function
1	1	FAULT1	Fault Status (Output): Internal pull-up or open-drain. Asserted LOW when Channel is in a thermal shutdown state or overcurrent condition for more than 5ms. MIC2072 latches this output in its asserted state upon an overcurrent condition. Toggling EN1 or removing the load will reset the circuit breaker latch and deassert FAULT1.
n/a	2	EN1	Enable (Input): Channel 1, active-high (-1) or active-low (-2). Toggling this input also resets the latched output of the MIC2072.
2	3	S3#	Control (Input): When this input is HIGH, the MAIN inputs are connected to OUT1 and OUT2 via 100mΩ MOSFET switches. When this input is LOW the AUX inputs are connected to OUT1 and OUT2 via 500mΩ MOSFET switches.
3	5	AUX	Auxiliary 5V Supply (Input): Also used as power supply for internal circuitry.
n/a	4, 6, 7	NC	No Connection: This pin may be connected to other pins without restriction.
4	8	GND	Ground
5	9, 10	OUT2	Channel 2 (Output): For MIC2012-1, -2 both pins must be externally connected together.
6	11, 12	MAIN	5V Main Supply (Input): All MAIN inputs must be connected together externally.
7	13, 14	OUT1	Channel 1 (Output): For MIC2012-1, -2 both pins must be externally connected together.
n/a	15	EN2	Enable (Input): Channel 2, active-high (-1) or active-low (-2). Toggling this input also resets the latched output of the MIC2072.
8	16	FAULT2	Fault Status (Output): Internal pull-up or open-drain. Asserted LOW when Channel 2 is in a thermal shutdown state or overcurrent condition for more than 5ms. MIC2072 latches this output in its asserted state upon an overcurrent condition. Toggling EN2 or removing the load will reset the circuit breaker latch and deassert FAULT2.

Absolute Maximum Ratings (Note 1, Note 4)

Supply Voltage (V_{IN} , V_{MAIN} , V_{AUX}).....	-0.3V to 6V
EN1, EN2, S3# Input Pins	-0.3V to 6V
FAULT#, OUT1, OUT2 Output Pins.....	-0.3V to 6V
FAULT Output Current.....	25mA
ESD Rating, Note 3	2kV

Operating Ratings (Note 2)

Supply Voltage (V_{MAIN} , V_{AUX}).....	+4.5V to +5.5V
Ambient Temperature (T_A).....	-0°C to +70°C
Junction Temperature (T_J).....	Internally Limited
Package Thermal Resistance	
QSOP (θ_{JA}).....	163°C/W
SOIC (θ_{JA}).....	160°C/W

Electrical Characteristics

$V_{MAIN} = 5V$; $AUX = 5V$; $T_A = 25^\circ C$; unless noted

Symbol	Parameter	Condition	Min	Typ	Max	Units
V_{MAIN}	MAIN Supply Voltage		4.5	5.0	5.5	V
$I_{MAIN(ON)}$	MAIN Supply Current Switches On Note 5	S3# = 1, no load		16	22	μA
$I_{MAIN(OFF)}$	MAIN Supply Current Switches Off Note 5 , (MIC20x2-1, MIC20x2-2 only)	S3# = 1, no load			5	μA
I_{LEAK}	MAIN Reverse Leakage Current,	S3# = 0, both switches ON, $V_{MAIN} = 0V$	-10		+10	μA
V_{AUX}	AUX Supply Voltage		4.5	5.0	5.5	V
$I_{AUX ON}$	AUX Supply Current, both switches on, Note 5	No load S3# = 0		0.6	1	mA
$I_{AUX OFF}$	AUX Supply Current, switches off. (MIC20x2-1, MIC20x2-2 only)	No load S3# = 0			5	μA
$V_{UV/AUX}$	AUX Undervoltage Lockout Threshold	V_{AUX} increasing V_{AUX} decreasing		3.1 2.9	4.0 3.8	V V
V_{HYS}	AUX Undervoltage Lockout Hysteresis			200		mV
R_{DSMAIN}	MAIN On-Resistance, Each Output	S3# = 1, $I_{OUT} = 500mA$		100	140	m Ω
R_{DSAUX}	AUX On-Resistance, Each Output	S3# = 0, $I_{OUT} = 100mA$		500	700	m Ω
$I_{LIMIT(MAIN)}$	MAIN Current-Limit Threshold	S3# = 1, $V_{OUT} = 4.0V$, ramped load	0.8		2.0	A
	MAIN Short-Circuit Current-Limit	$V_{OUT} = 0V$	0.65		1.8	A
$I_{LIMIT(AUX)}$	AUX Current-Limit Threshold	S3# = 0, $V_{OUT} = 4.0V$, ramped load	105	150	195	mA
	AUX Short-Circuit Current-Limit	$V_{OUT} = 0V$, $C_{OUT} = 100\mu F$		80		mA
V_{TH}	S3#, EN1, EN2. Input Threshold Voltage (EN1, EN2, for MIC20x2-x only)	High-to-Low transition	0.8	1.5		V
		Low-to-High transition		1.7	2.0	V
V_{HYS}	EN1, EN2 and S3# Input Hysteresis (EN1, EN2, for MIC20x2-x only)			200		mV
I_{IN}	S3#, EN1, EN2 Input Current (EN1, EN2, for MIC20x2-x only)	$V_{S3/EN} = 5V, 0V$	-1		1	μA
I_{OFF}	OUT1, OUT2 Leakage Current (MIC2012-x, MIC2072-x only)	Outputs are off, $V_{OUT} = 0$	-10		10	μA
	Pull-Up Current During Latched Output State (MIC2072-1, -2)	Outputs latched off		1		mA

Symbol	Parameter	Condition	Min	Typ	Max	Units
$V_{TH\ LATCH}$	Latch Reset Threshold (MIC2072, MIC2072-x only)	V_{OUT} Rising		1.95		V
	Minimum Output Slew Rate to Reset Latch (MIC2072, MIC2072-x only), Note 6			0.4		V/s
	Overtemperature Threshold	T_J increasing, single channel T_J decreasing, single channel T_J increasing, both channels T_J decreasing, both channels		140 120 160 150		°C °C °C °C
V_{OL}	FAULT Output Low Voltage	$I_{FAULT} = 5\text{mA}$			0.2	V
V_{OH}	FAULT Output High Voltage (MIC2012-1P,-2P),(MIC2072-1P,-2P)	$I_{FAULT} = -20\mu\text{A}$	4			V
	FAULT Output Off Current (Not Applicable to 'P' Options)	$V_{FAULT} = 5\text{V}$		0.2	10	μA
T_H	MAIN to S3# Hold Time, Note 6	Figure 5	5			ms
T_S	MAIN to S3# Set-up Time, Note 6	Figure 5	0			ms
t_{DLY}	FAULT Delay Filter Response Time (Overcurrent only), Note 7	Output shorted to ground, Figure 4	5	10	20	ms
t_{OC}	Overcurrent Response Time	Output shorted to ground, Figure 4 MAIN output AUX output		2 2		μs μs
$t_{ON(MAIN)}$	MAIN Output Turn-On Time	$R_L = 10\Omega$, $C_L = 1\mu\text{F}$, Figure 3		2		ms
$t_{OFF(MAIN)}$	MAIN Output Turn-Off Time (MIC20x2-x only)	$R_L = 10\Omega$, $C_L = 1\mu\text{F}$, Figure 3		35		μs
$t_{r(MAIN)}$	MAIN Output Rise Time	$R_L = 10\Omega$, $C_L = 1\mu\text{F}$, Figure 3		2		ms
$t_{f(MAIN)}$	MAIN Output Fall Time (MIC20x2-x only)	$R_L = 10\Omega$, $C_L = 1\mu\text{F}$, Figure 3		32		μs
$t_{ON(AUX)}$	AUX Output Turn-On Time	$R_L = 50\Omega$, $C_L = 1\mu\text{F}$, Figure 3		0.6		ms
$t_{OFF(AUX)}$	AUX Output Turn-Off Time (MIC20x2-x only)	$R_L = 50\Omega$, $C_L = 1\mu\text{F}$, Figure 3		120		μs
$t_{r(AUX)}$	AUX Output Rise Time	$R_L = 50\Omega$, $C_L = 1\mu\text{F}$, Figure 3		0.5		ms
$t_{f(AUX)}$	AUX Output Fall Time (MIC20x2-x only)	$R_L = 50\Omega$, $C_L = 1\mu\text{F}$, Figure 3		115		μs
t_{XMA}	MAIN to AUX Cross Conduction Time, Note 8	S3# transition to 0		5	7.5	ms
t_{XAM}	AUX to MAIN Cross Conduction Time, Note 8	S3# transition to 1		5	7.5	ms

Note 1. Exceeding the absolute maximum rating may damage the device.

Note 2. The device is not guaranteed to function outside its operating rating.

Note 3. Devices are ESD sensitive. Handling precautions recommended. Human body model, 1.5k in series with 100pF.

Note 4. All voltages are referenced to ground.

Note 5. For MIC20x2-1(P) OFF occurs when $V_{EN} < 0.8\text{V}$ and ON occurs when $V_{EN} > 2.4\text{V}$. For MIC20x2-2(P) OFF occurs when $V_{EN} > 2.4\text{V}$ and ON occurs when $V_{EN} < 0.8\text{V}$.

Note 6. Guaranteed by design. Not production tested.

Note 7. Assumes only one channel in current-limit. Delay circuitry is shared among channels so it is possible for t_{DLY} to be 40ms max if one channel enters current-limit as the other is about to time-out.

Note 8. Cross conduction time is the duration in which both MAIN and AUX internal switches are on subsequent to S3# transitioning.

Timing Diagrams

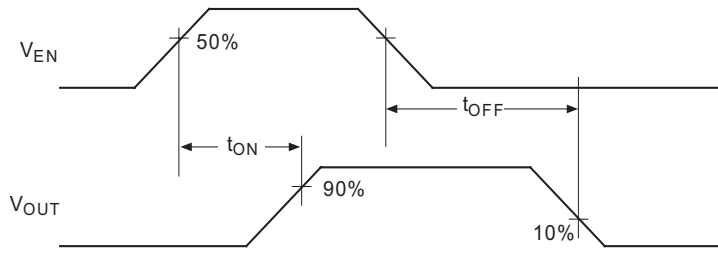

Figure 2. MIC2012/72-1

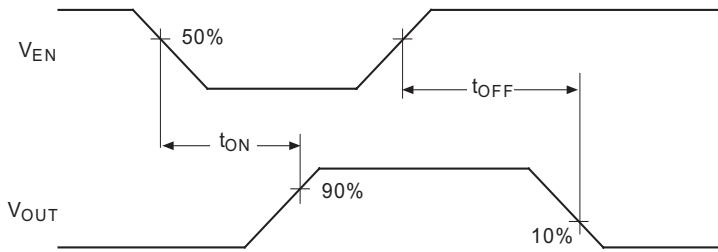

Figure 3. MIC2012/72-2

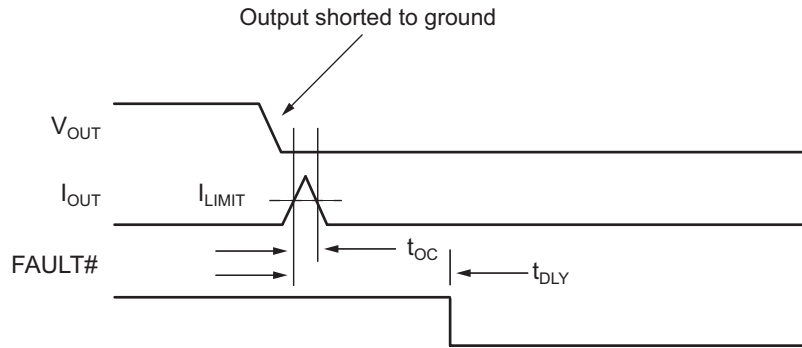

Figure 4. Overcurrent Response Timing

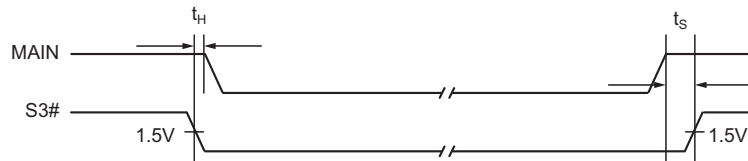
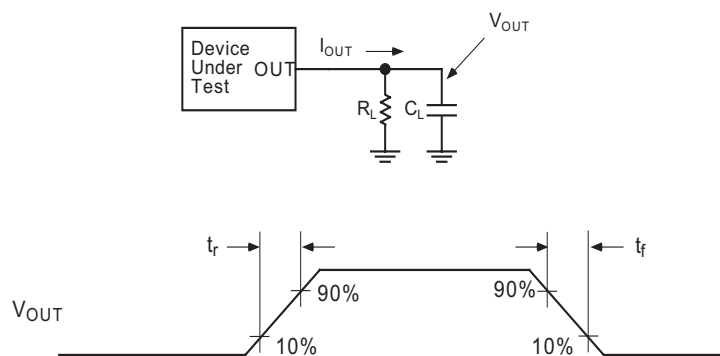
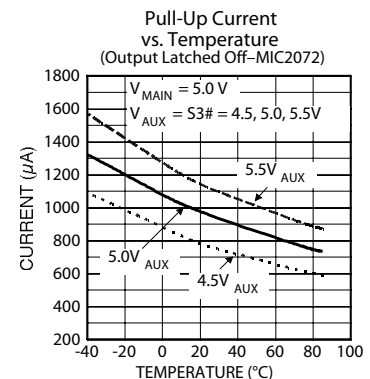
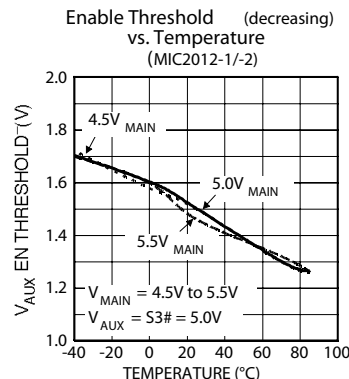
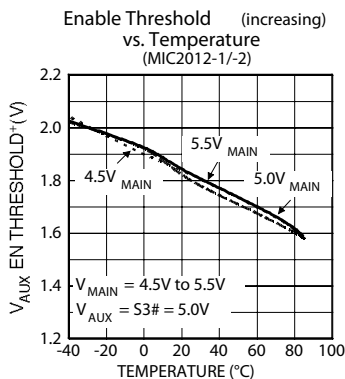
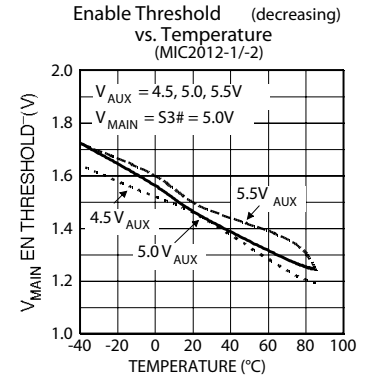
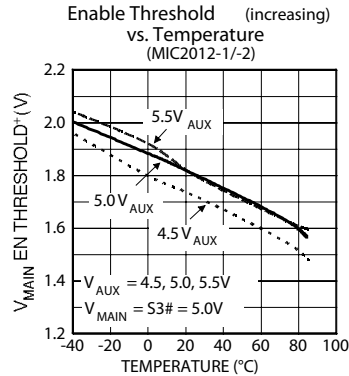
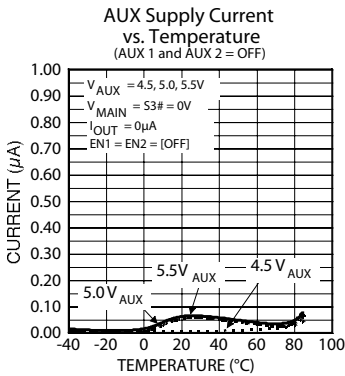
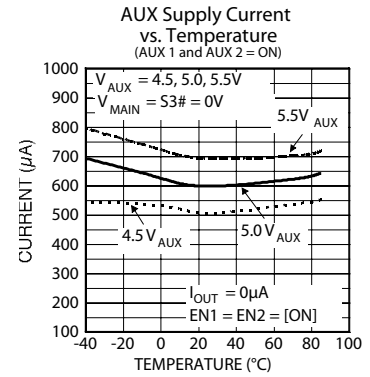
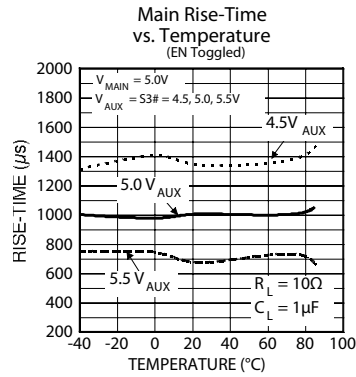
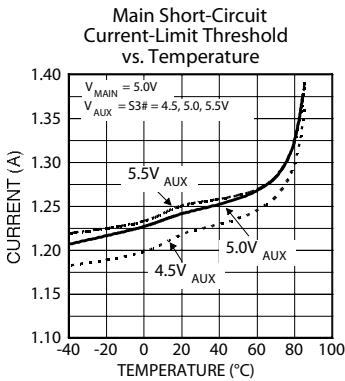
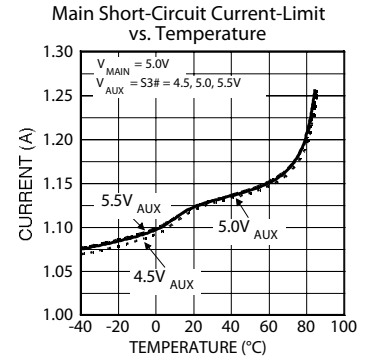
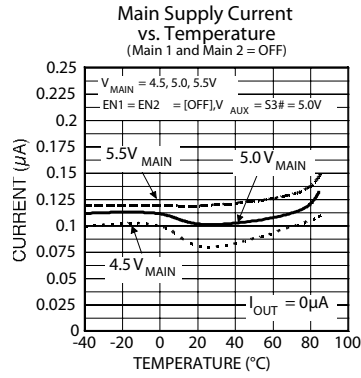
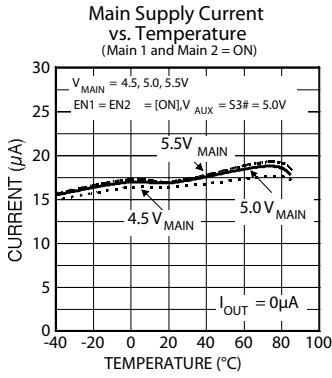
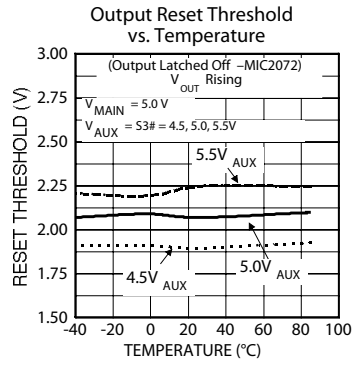

Figure 5. MAIN to S3# Timing

Test Circuit

Typical Characteristics





Functional Characteristics

AUX Start-up by UVLO

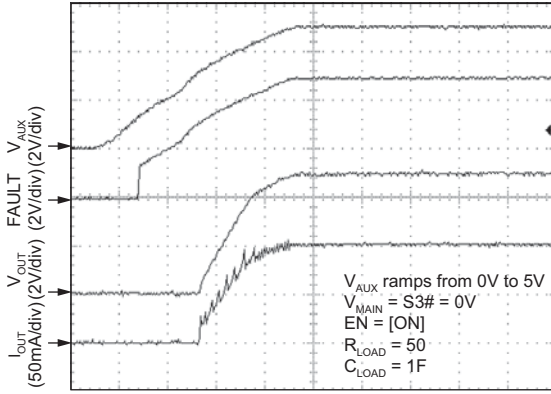

TIME (500s/div)

AUX Shutdown by UVLO

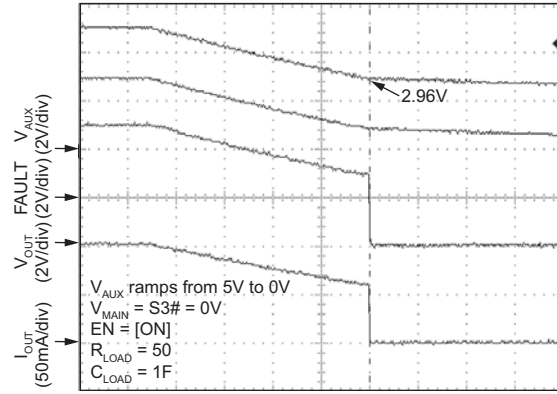

TIME (10ms/div)

Main Start-up by UVLO

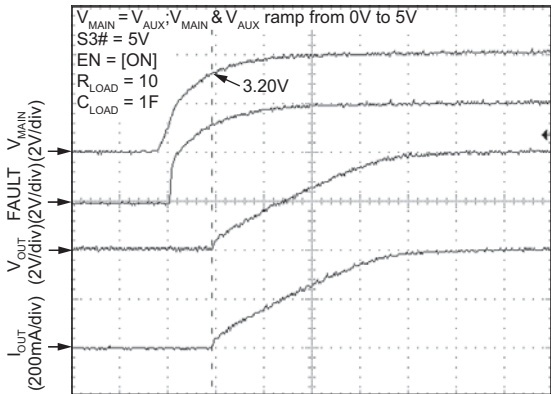

TIME (500s/div)

Main Shut-down by UVLO

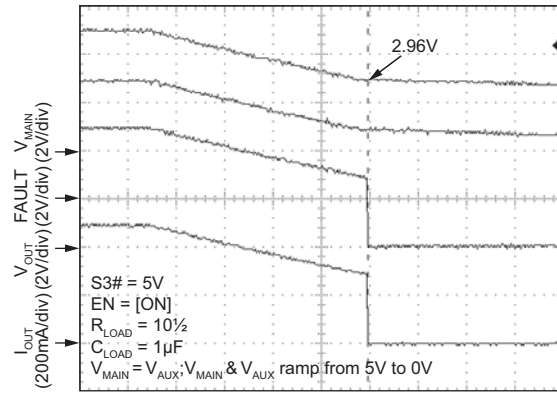

TIME (10ms/div)

Main Turn-On Response

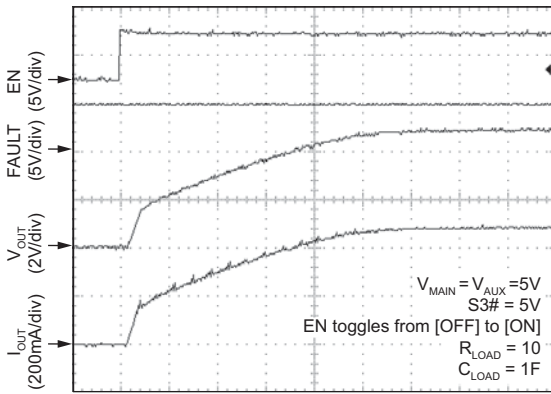

TIME (250s/div)

Main Turn-Off Response

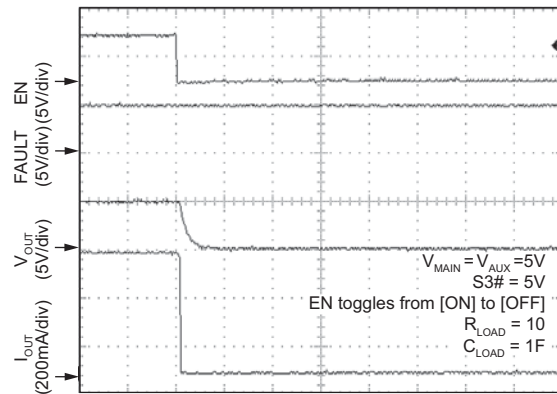

TIME (100s/div)

AUX Turn-On Response

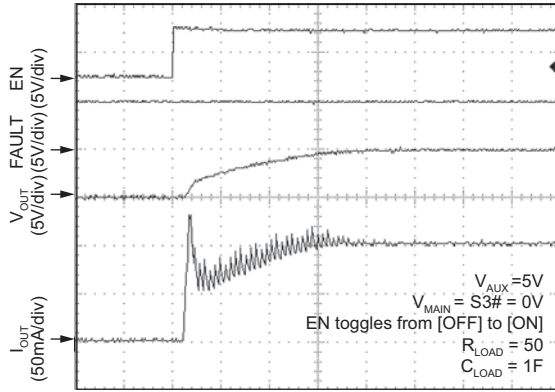

TIME (100s/div)

AUX Turn-Off Response

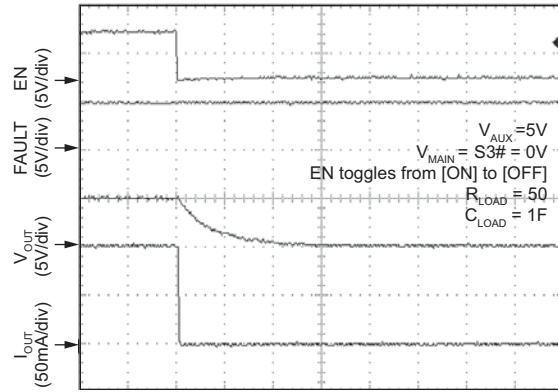

TIME (100s/div)

Turn-On from S3# to AUX

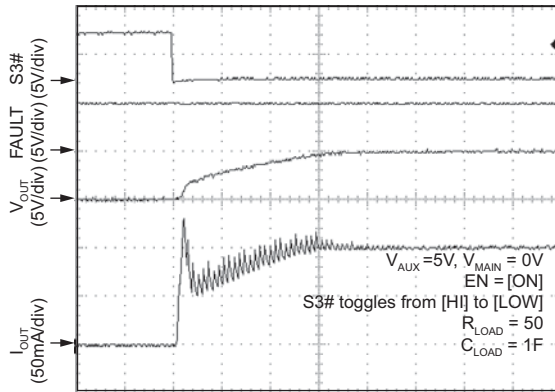

TIME (100s/div)

Turn-Off from AUX to S3#

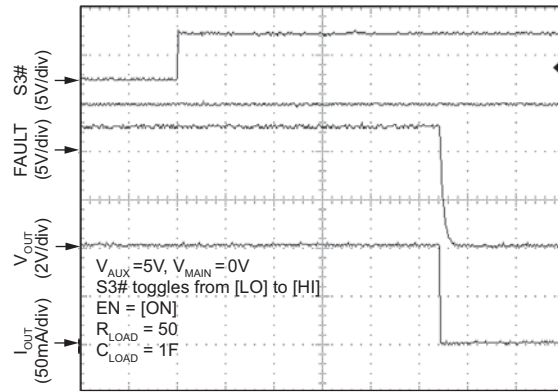

TIME (1ms/div)

Main Inrush Current into C_{LOAD}

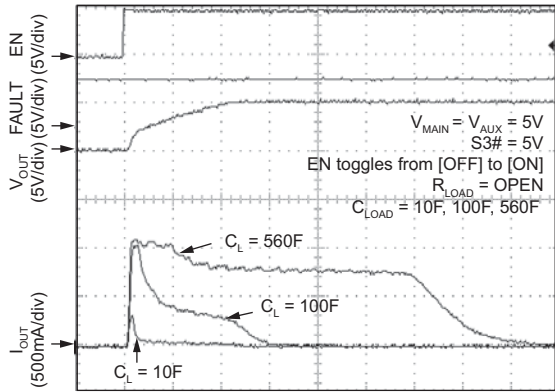

TIME (500s/div)

Main-Ramped to Short by MOSFET

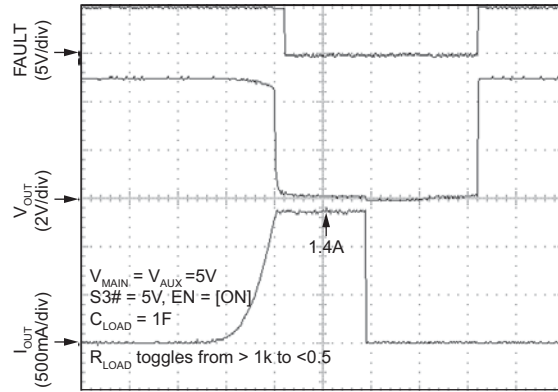

TIME (50ms/div)

AUX Ramped to Short by MOSFET

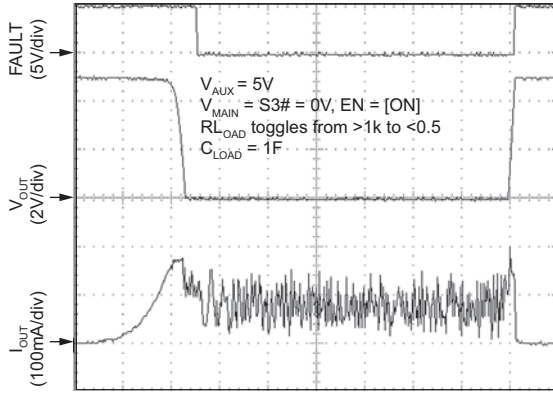

TIME (25ms/div)

Main Turn-On into Short

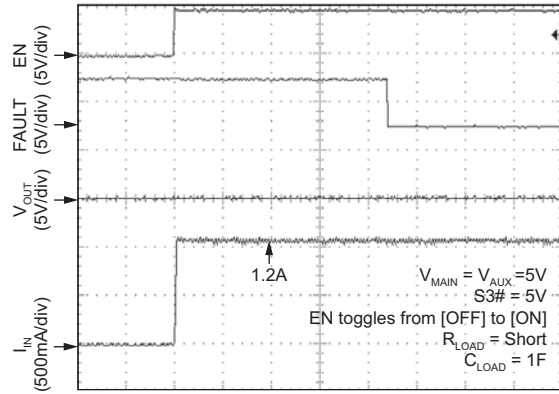

TIME (2.5ms/div)

AUX Turn-On into Short

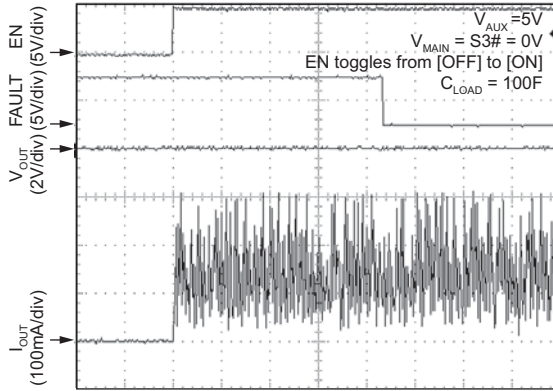

TIME (2.5ms/div)

AUX Inrush Current into Large C_LOAD

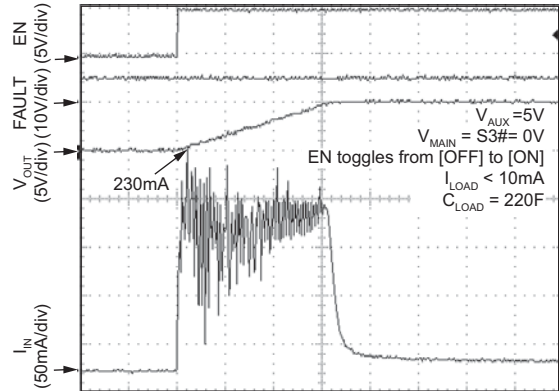

TIME (2.5ms/div)

AUX Inrush Current into Small C_LOAD

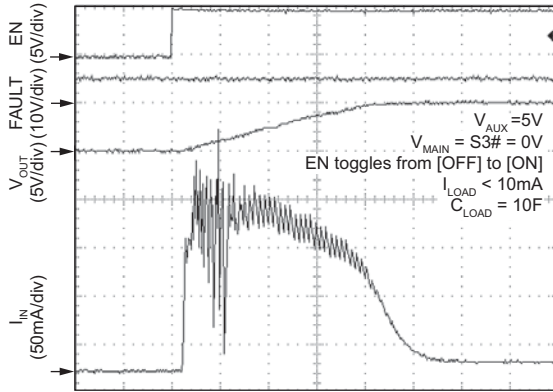

TIME (100s/div)

Main-to-AUX Cross Conduction

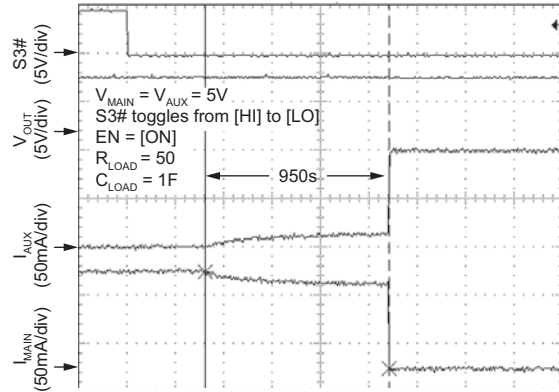

TIME (250s/div)

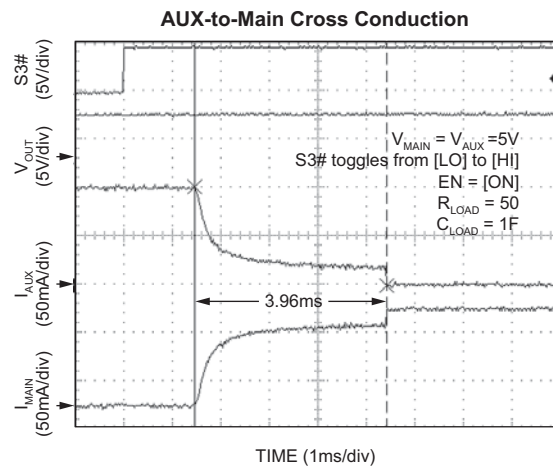

Functional Diagram

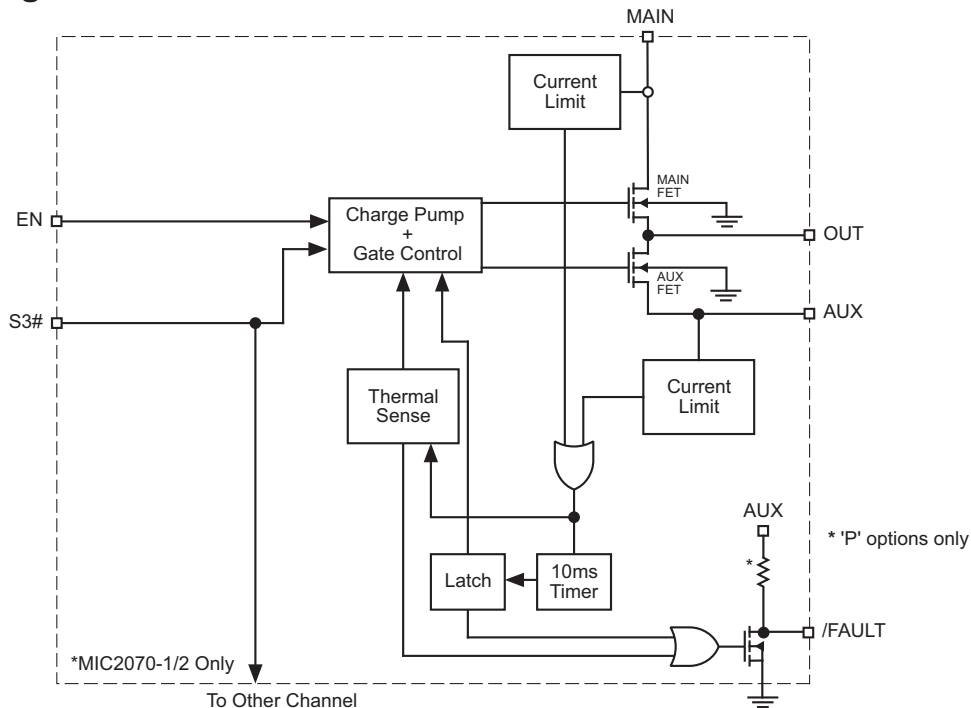

Functional Description

The MIC2012/2072 are designed to support the power distribution requirements for USB wakeup from the ACPI S3 state. It integrates two independent channels under control of input S3#. When S3# is asserted LOW (S3 state) the MIC2012/2072 will switch a 500mΩ, 100mA MOSFET switch from the AUX input to each of its two outputs. Conversely when the S3# input is HIGH (S0 state) the MIC2012/72 will switch a 100mΩ, 500mA MOSFET switch from the MAIN input to each of its two outputs. The lower current limit during the ACPI S3 state helps to ensure that the standby supply maintains regulation even during fault conditions.

Thermal Shutdown

Thermal shutdown is employed to protect the device from damage should the die temperature exceed safe margins due mainly to short circuit faults. Thermal shutdown shuts off the output MOSFET and asserts the FAULT output if the die temperature reaches 140°C and the overheated channel is in current limit. The other channel is not affected. If, however, the die temperature exceeds 160°C, both channels will be shut off even if neither channel is in current limit.

Power Dissipation

The device's junction temperature depends on several factors such as the load, PCB layout, ambient temperature and package type. The power dissipated in each channel is

$P_D = R_{DS(on)} \times I_{OUT}^2$ where $R_{DS(on)}$ is the on-resistance of the internal MOSFETs and I_{OUT} is the continuous output current.

Total power dissipation of the device will be the summation of P_D for both channels. To relate this to junction temperature, the following equation can be used:

$$T_J = P_D \times \theta_{JA} + T_A$$

where:

T_J = junction temperature

T_A = ambient temperature

θ_{JA} = is the thermal resistance of the package

Current Sensing and Limiting

The current-limit thresholds are preset internally for each state. The preset level prevents damage to the device and external load but still allows a minimum current of 100mA or 500mA to be delivered to the load depending on the state of the device according to the S3# input. When S3# is LOW the current-limit is set at 100mA minimum. When S3# is HIGH the current-limit is set at 500mA minimum.

Should an over-current condition last longer than t_{DLY} , the MIC2072 will latch the faulty output off. The output will remain off until either the load is removed or the EN signal (MIC2072-1, -2) is toggled. When the MIC2072 enters a latched output condition a 1mA pull-up current source is activated. This provides a way to automatically reset the output once the load is removed without the need to toggle the enable input such as in the MIC2072. Please refer to Figure 7 for timing details.

The MIC2012 will automatically reset its output when the die temperature cools down to 120°C. The MIC2012 output and FAULT signal will continue to cycle on and off until the device is disabled or the fault is removed. Figure 6 depicts typical timing. Depending on PCB layout, package, ambient temperature, etc., it may take several hundred milliseconds from the incidence of the fault to the output MOSFET being shut off. This time duration will be shortest in the case of a

dead short on the output.

Fault Status Output

The FAULT signal is an active-low output with an open-drain or weak pull-up configuration. FAULT is asserted (active-low) when either an overcurrent or thermal shutdown condition occurs. In the case of an overcurrent condition, FAULT will be asserted only after the flag response delay time, t_{DLY} , has elapsed. This ensures that FAULT is asserted only upon valid overcurrent conditions and that erroneous error reporting is eliminated. For example, false overcurrent conditions can occur during hot-plug events when a highly capacitive load is connected and causes a high transient inrush current that

exceeds the current-limit threshold. The FAULT response delay time t_{DLY} is typically 10ms.

Undervoltage Lockout

Undervoltage lockout (UVLO) prevents the output MOSFET from turning on until the AUX input exceeds approximately 3.5V. UVLO ensures that the output MOSFETs remain off to prevent high transient inrush current due to stray or bulk load capacitance. This helps to ensure that the power supply

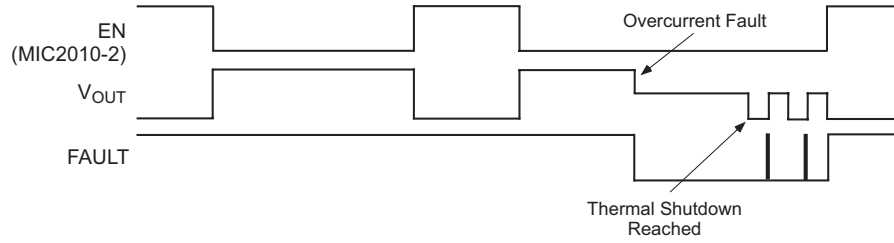
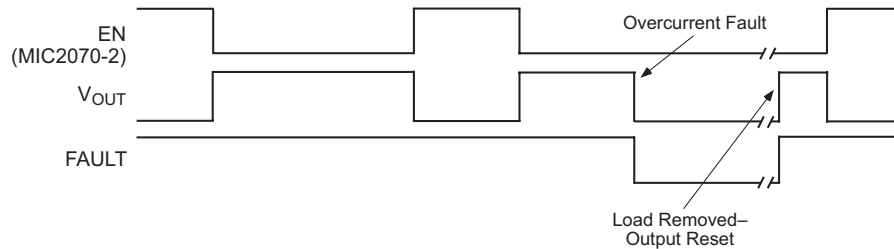

Figure 6. MIC2012 System Timing



**Figure 7. MIC2072 System Timing—
Output Resets When Load is Removed**