



# MIC5206

## 150mA Low-Noise LDO Regulator

### General Description

The MIC5206 is an efficient linear voltage regulator with very low dropout voltage (typically 17mV at light loads and 165mV at 150mA), and very low ground current (600µA at 100mA output), with better than 1% initial accuracy. It has a logic compatible enable/shutdown control input and an internal undervoltage monitor.

Designed especially for hand-held, battery-powered devices, the MIC5206 can be switched by a CMOS or TTL compatible logic signal. When disabled, power consumption drops nearly to zero. Dropout ground current is minimized to prolong battery life.

Key features include an undervoltage monitor with an error flag output, a reference bypass pin to improve its already low-noise performance (8-pin versions only), reversed-battery protection, current limiting, and overtemperature shutdown.

The MIC5206 is available in several fixed voltages in a tiny SOT-23-5 package. It features a pinout, similar to the LP2980, but has significantly better performance. Fixed and adjustable output voltage versions, featuring the reference bypass option, are available in the 8-pin Micrel Mini 8™ 8-pin MSOP (micro small-outline package).

*For low-dropout regulators that are stable with ceramic output capacitors, see the µCap MIC5245/6/7 family.*

Data sheets and support documentation can be found on Micrel's web site at [www.micrel.com](http://www.micrel.com).

### Features

- Error flag indicates undervoltage fault
- High output voltage accuracy
- Guaranteed 150mA output
- Ultra-low-noise output (8-pin versions)
- Low quiescent current
- Low dropout voltage
- Extremely tight load and line regulation
- Very low temperature coefficient
- Current and thermal limiting
- Reversed-battery protection
- “Zero” off-mode current
- Logic-controlled electronic enable

### Applications

- Cellular telephones
- Laptop, notebook, and palmtop computers
- Battery-powered equipment
- PCMCIA V<sub>CC</sub> and V<sub>PP</sub> regulation/switching
- Consumer/personal electronics
- SMPS post-regulator/dc-to-dc modules
- High-efficiency linear power supplies

### Typical Application

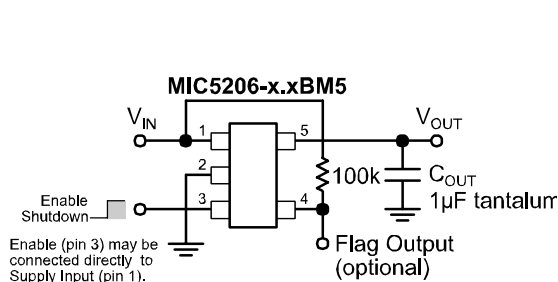

SOT-23-5 Fixed Voltage Application

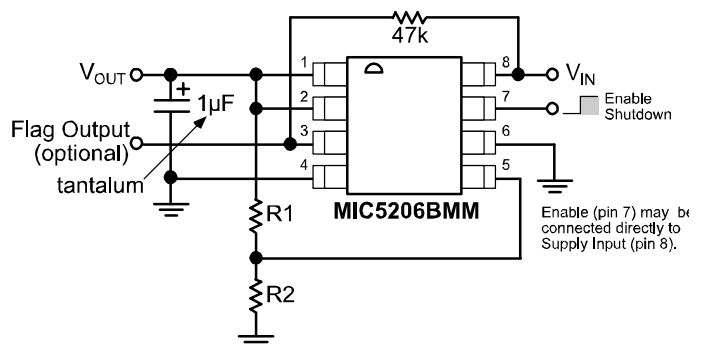

Adjustable Voltage Application

Micrel Mini 8 is a trademark of Micrel, Inc.

Micrel Inc. • 2180 Fortune Drive • San Jose, CA 95131 • USA • tel +1 (408) 944-0800 • fax + 1 (408) 474-1000 • <http://www.micrel.com>

May 2006

M9999-051506  
(408) 955-1690

## Ordering Information

Part Number				Voltage*	Junction Temp. Range	Package
Standard	Marking	Pb-Free	Marking			
MIC5206-2.5BM5	LD25	MIC5206-2.5YM5	<u>LD</u> 25	2.5V	-40° to +125°C	5-Pin SOT-23
MIC5206-2.7BM5	LD27	MIC5206-2.7YM5	<u>LD</u> 27	2.7V	-40° to +125°C	5-Pin SOT-23
MIC5206-3.0BM5	LD30	MIC5206-3.0YM5	<u>LD</u> 30	3.0V	-40° to +125°C	5-Pin SOT-23
MIC5206-3.2BM5	LD32	MIC5206-3.2YM5	<u>LD</u> 32	3.2V	-40° to +125°C	5-Pin SOT-23
MIC5206-3.3BM5	LD33	MIC5206-3.3YM5	<u>LD</u> 33	3.3V	-40° to +125°C	5-Pin SOT-23
MIC5206-3.6BM5	LD36	MIC5206-3.6YM5	<u>LD</u> 36	3.6V	-40° to +125°C	5-Pin SOT-23
MIC5206-3.8BM5	LD38	MIC5206-3.8YM5	<u>LD</u> 38	3.8V	-40° to +125°C	5-Pin SOT-23
MIC5206-4.0BM5	LD40	MIC5206-4.0YM5	<u>LD</u> 40	4.0V	-40° to +125°C	5-Pin SOT-23
MIC5206-5.0BM5	LD50	MIC5206-5.0YM5	<u>LD</u> 50	5.0V	-40° to +125°C	5-Pin SOT-23
MIC5206BMM		MIC5206YMM		ADJ	-40° to +125°C	8-Pin MSOP
MIC5206-3.0BMM		MIC5206-3.0YMM		3.0V	-40° to +125°C	8-Pin MSOP
MIC5206-3.3BMM		MIC5206-3.3YMM		3.3V	-40° to +125°C	8-Pin MSOP
MIC5206-3.6BMM		MIC5206-3.6YMM		3.6V	-40° to +125°C	8-Pin MSOP
MIC5206-3.8BMM		MIC5206-3.8YMM		3.8V	-40° to +125°C	8-Pin MSOP
MIC5206-4.0BMM		MIC5206-4.0YMM		4.0V	-40° to +125°C	8-Pin MSOP
MIC5206-5.0BMM		MIC5206-5.0YMM		5.0V	-40° to +125°C	8-Pin MSOP

\* Other voltages available. Contact Micrel for details.

## Pin Configuration

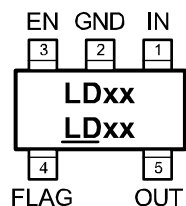

**MIC5206-xxBM5/YM5**  
(Fixed Output Voltage)

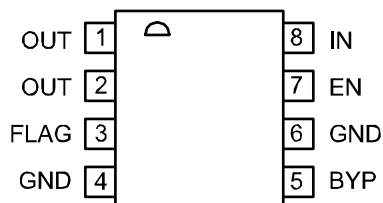

**MIC5206-xxBMM/YMM**  
(Fixed Output Voltage)

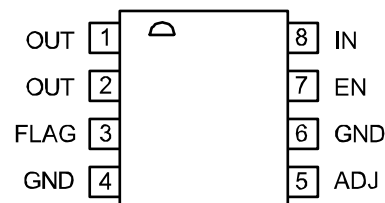

**MIC5206-BMM/YMM**  
(Adjustable Output Voltage)

## Pin Description

Pin Number SOT-23-5	Pin Number MSOP-8	Pin Name	Pin Function
1	8	IN	Supply Input
2	4, 6	GND	Ground
3	7	EN	Enable/Shutdown (Input): CMOS compatible input. Logic high = enable, logic low or open = shutdown. Do not leave floating.
4	3	FLAG	Error Flag (Output): Open-collector output. Active low indicates an output undervoltage condition
	5 (fixed)	BYP	Reference Bypass: Connect external 470pF capacitor to GND to reduce output noise. May be left open
	5 (adj.)	ADJ	Adjust (Input): Adjustable regulator feedback input. Connect to resistor voltage divider.
5	1, 2	OUT	Regulator Output

### Absolute Maximum Ratings<sup>(1)</sup>

Supply Input Voltage ( $V_{IN}$ )..... –20V to +20V  
 Enable Input Voltage ( $V_{EN}$ )..... –20V to +20V  
 Power Dissipation ( $P_D$ )..... Internally Limited <sup>(3)</sup>  
 Junction Temperature ( $T_J$ ) ..... –40°C to +125°C  
 Lead Temperature (soldering, 5 sec)..... 260°C

### Operating Ratings<sup>(2)</sup>

Supply Input Voltage ( $V_{IN}$ )..... +2.5V to +16V  
 Enable Input Voltage ( $V_{EN}$ )..... 0V to  $V_{IN}$   
 Junction Temperature ..... –40°C to +125°C  
     SOT-23-5 ( $\theta_{JA}$ )<sup>(3)</sup>  
     MSOP-8 ( $\theta_{JA}$ )<sup>(3)</sup>

### Electrical Characteristics

$V_{IN} = V_{OUT} + 1V$ ;  $I_L = 100\mu A$ ;  $C_L = 1.0\mu F$ ;  $V_{EN} \geq 2.0V$ ;  $T_J = 25^\circ C$ , **bold** values indicate  $-40^\circ C \leq T_J \leq +125^\circ C$ , unless noted.

Symbol	Parameter	Condition	Min	Typ	Max	Units
$V_O$	Output Voltage Accuracy	Variation from nominal $V_{OUT}$	–1 –2		1 2	% %
$\Delta V_O/\Delta T$	Output Voltage Temperature Coefficient	<b>Note 4</b>		<b>40</b>		ppm/°C
$\Delta V_O/V_O$	Line Regulation	$V_{IN} = V_{OUT} + 1V$ to 16V				
$\Delta V_O/V_O$	Load Regulation	$I_L = 0.1mA$ to 150mA, <b>Note 5</b>				
$V_{IN} - V_O$	Dropout Voltage, <b>Note 6</b>	$I_L = 100\mu A$  $I_L = 50mA$  $I_L = 100mA$  $I_L = 150mA$		17 110 140 165	50 <b>70</b> 150 <b>230</b> 250 <b>300</b> 275 <b>350</b>	mV mV mV mV mV mV
$I_{GND}$	Quiescent Current	$V_{EN} \leq 0.4V$ (shutdown) $V_{EN} \leq 0.18V$ (shutdown)		0.01	1 <b>5</b>	$\mu A$ $\mu A$
$I_{GND}$	Ground Pin Current, <b>Note 7</b>	$V_{EN} \geq 2.0V$ , $I_L = 100\mu A$  $I_L = 50mA$  $I_L = 100mA$  $I_L = 150mA$		80 350 600 1300	125 <b>150</b> 600 <b>800</b> 1000 <b>1500</b> 1900 <b>2500</b>	$\mu A$ $\mu A$ $\mu A$ $\mu A$ $\mu A$ $\mu A$ $\mu A$ $\mu A$
PSRR	Ripple Rejection			75		dB
$I_{LIMIT}$	Current Limit	$V_{OUT} = 0V$		<b>320</b>	500	mA
$\Delta V_O/\Delta P_D$	Thermal Regulation	<b>Note 8</b>		0.05		%/W
$e_{no}$	Output Noise	$I_L = 50mA$ , $C_L = 4.7\mu F$ , 470pF from BYP to GND (MM package only)		260		$nV\sqrt{Hz}$
<b>Enable Input</b>						
$V_{IL}$	Enable Input Logic-Low Voltage	Regulator shutdown			0.4 <b>0.18</b>	V V
$V_{IH}$	Enable Input Logic-High Voltage	Regulator enable	<b>2.0</b>			V
$I_{IL}$ $I_{IH}$	Enable Input Current	$V_{IL} \leq 0.4V$ $V_{IL} \leq 0.18V$ $V_{IH} \geq 2.0V$ $V_{IH} \geq 2.0V$		0.01 5	–1 –2 20 <b>25</b>	$\mu A$ $\mu A$ $\mu A$ $\mu A$

Symbol	Parameter	Condition	Min	Typ	Max	Units
<b>Error Flag Output</b>						
V <sub>ERR</sub>	Flag Threshold	Undervoltage condition (below nominal) <b>Note 9</b>	-2	-6	-10	%
V <sub>OL</sub>	Output Logic-Low Voltage	I <sub>L</sub> = 1mA, undervoltage condition		0.2	<b>0.4</b>	V
I <sub>FL</sub>	Flag Leakage Current	Flag off, V <sub>FLAG</sub> = 0V to 16V	-1	0.1	+1	μA

**Notes:**

- Exceeding the absolute maximum rating may damage the device.
- The device is not guaranteed to function outside its operating rating.
- The maximum allowable power dissipation at any T<sub>A</sub> (ambient temperature) is  $P_{D(max)} = (T_{J(max)} - T_A) / \theta_{JA}$ . Exceeding the maximum allowable power dissipation will result in excessive die temperature, and the regulator will go into thermal shutdown. The  $\theta_{JA}$  of the MIC5205-x.xBM5 (all versions) is 220°C/W, and the MIC5206-x.xBMM (all versions) is 200°C/W, mounted on a PC board (see "Thermal Considerations" for further details).
- Output voltage temperature coefficient is defined as the worst case voltage change divided by the total temperature range.
- Regulation is measured at constant junction temperature using low duty cycle pulse testing. Parts are tested for load regulation in the load range from 0.1mA to 150mA. Changes in output voltage due to heating effects are covered by the thermal regulation specification.
- Dropout Voltage is defined as the input to output differential at which the output voltage drops 2% below its nominal value measured at 1V differential.
- Ground pin current is the regulator quiescent current plus pass transistor base current. The total current drawn from the supply is the sum of the load current plus the ground pin current.
- Thermal regulation is defined as the change in output voltage at a time "t" after a change in power dissipation is applied, excluding load or line regulation effects. Specifications are for a 150mA load pulse at V<sub>IN</sub> = 16V for t = 10ms.
- The error flag comparator includes 3% hysteresis.

# Typical Characteristics

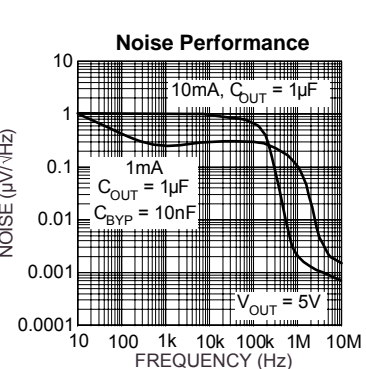
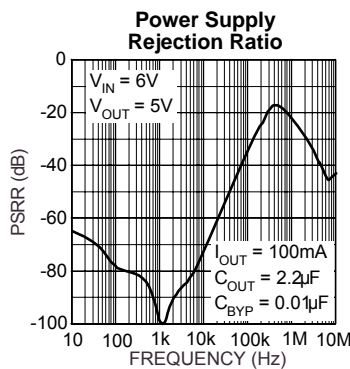
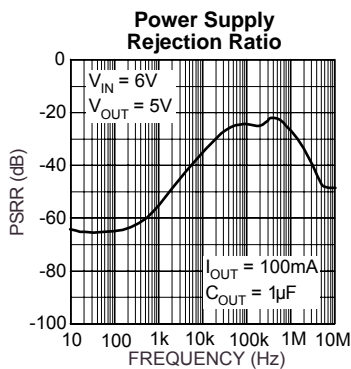
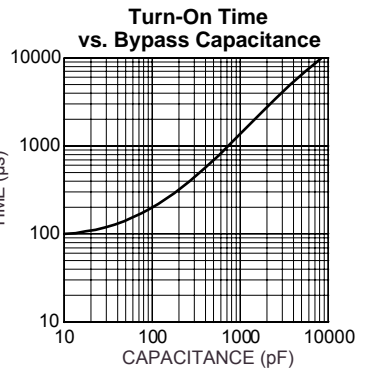
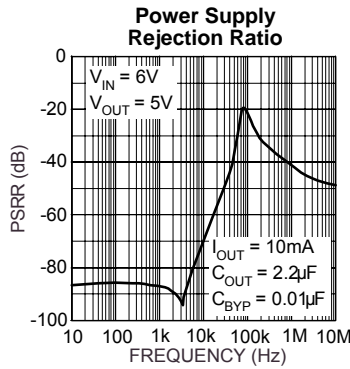
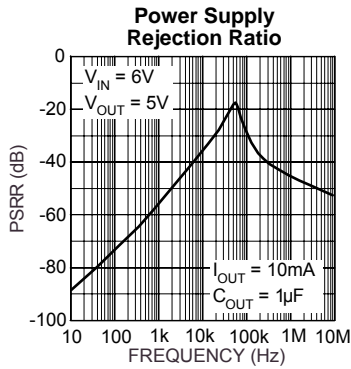
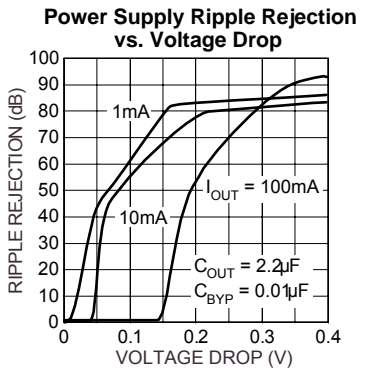
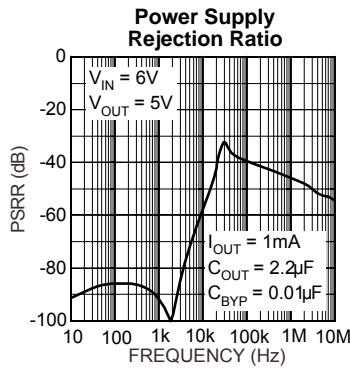
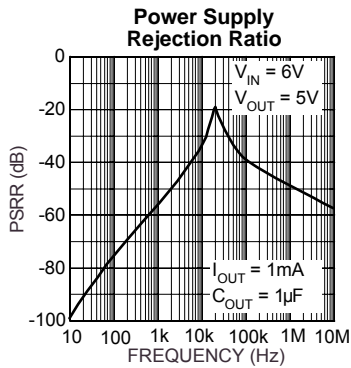
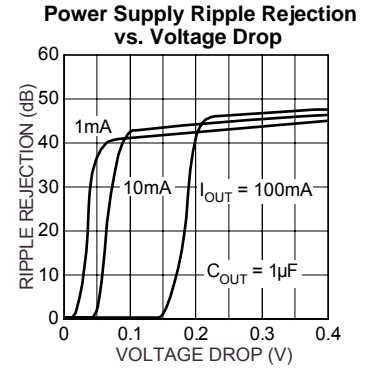
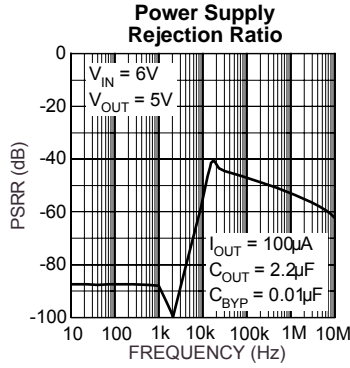
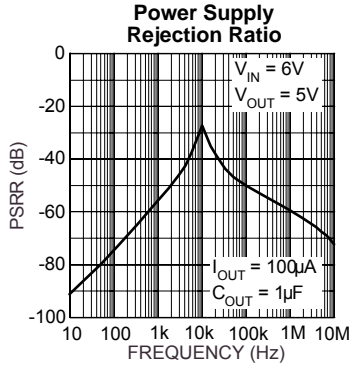

# Typical Characteristics

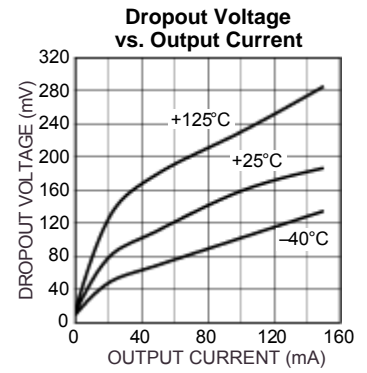
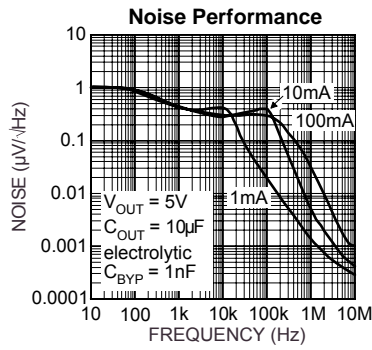
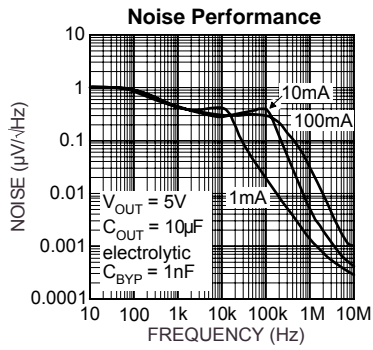
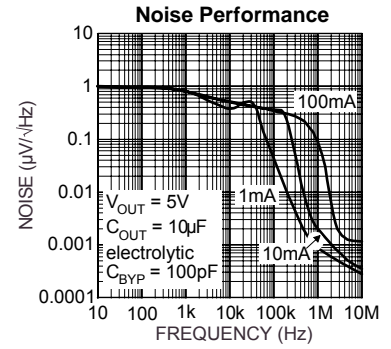
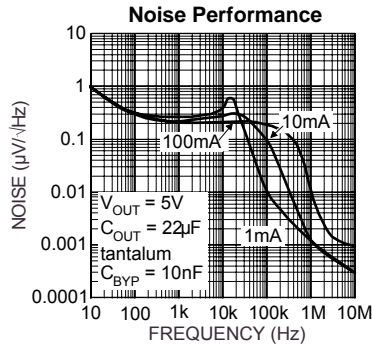
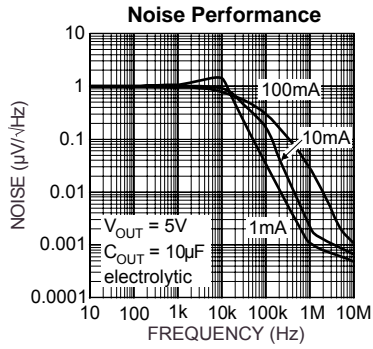

## Application Information

### Enable/Shutdown

Forcing EN (enable/shutdown) high (> 2V) enables the regulator. EN is compatible with CMOS logic gates.

If the enable/shutdown feature is not required, connect EN (enable) to IN (supply input). Refer to the text with Figures 1a and 2.

### Input Capacitor

A 1 $\mu$ F capacitor should be placed from IN to GND if there is more than 10 inches of wire between the input and the ac filter capacitor or if a battery is used as the input.

### Reference Bypass Capacitor

BYP (reference bypass) is connected to the internal voltage reference. A 470pF capacitor ( $C_{BYP}$ ) connected from BYP to GND quiets this reference, providing a significant reduction in output noise. See Figure 2.  $C_{BYP}$  reduces the regulator phase margin; when using  $C_{BYP}$ , output capacitors of 2.2 $\mu$ F or greater are generally required to maintain stability.

The start-up speed of the MIC5206 is inversely proportional to the size of the reference bypass capacitor. Applications requiring a slow ramp-up of output voltage should consider larger values of  $C_{BYP}$ . Likewise, if rapid turn-on is necessary, consider omitting  $C_{BYP}$ .

If output noise is not a major concern, omit  $C_{BYP}$  and leave BYP open.

### Output Capacitor

An output capacitor is required between OUT and GND to prevent oscillation. The minimum size of the output capacitor is dependent upon whether a reference bypass capacitor is used. 1.0 $\mu$ F minimum is recommended when  $C_{BYP}$  is not used (see Figure 2). 2.2 $\mu$ F minimum is recommended when  $C_{BYP}$  is 470pF (see Figure 2). Larger values improve the regulator's transient response. The output capacitor value may be increased without limit.

The output capacitor should have an ESR (effective series resistance) of about 5 $\Omega$  or less and a resonant frequency above 1MHz. Most tantalum or aluminum electrolytic capacitors are adequate; film types will work, but are more expensive. Since many aluminum electrolytics have electrolytes that freeze at about -30°C, solid tantalums are recommended for operation below -25°C.

At lower values of output current, less output capacitance is required for output stability. The capacitor can be reduced to 0.47 $\mu$ F for current below 10mA or 0.33 $\mu$ F for currents below 1mA.

### No-Load Stability

The MIC5205 will remain stable and in regulation with no load (other than the internal voltage divider) unlike many other voltage regulators. This is especially important in CMOS RAM keep-alive applications.

### Error Flag Output

The error flag is an open-collector output and is active (low) when an undervoltage of approximately 5% below the nominal output voltage is detected. A pull-up resistor from IN to FLAG is shown in all schematics.

If an error indication is not required, FLAG may be left open and the pull-up resistor may be omitted.

### Enable Pin Ramp and the Error Flag

To prevent indeterminate behavior on the error flag during power down of the device, ensure that the fall time of the enable pin signal, from logic high to logic low, is faster than 100 $\mu$ s.

### Fixed Regulator Applications

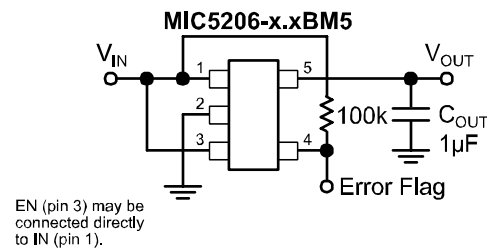

Figure 1a. Low-Noise Fixed Voltage Application

EN (pin 3) is shown connected to IN (pin 1) for an application where enable/shutdown is not required. The error flag is shown with a 100k $\Omega$  pull-up resistor.

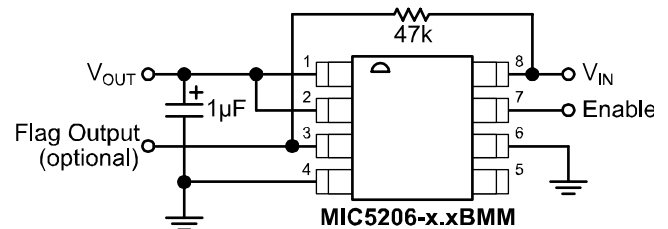
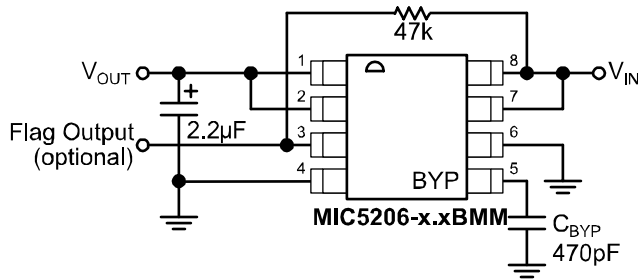

Figure 1b. Low-Noise Fixed Voltage Application

Figure 1b is an example of a basic configuration where the lowest-noise operation is not required.  $C_{OUT}$  = 1 $\mu$ F minimum. The error flag is shown with a 47k $\Omega$  pull-up resistor.



**Ultra-Low-Noise Application**



**Figure 2. Ultra-Low-Noise Fixed Voltage Application**

Figure 2 includes a 470pF capacitor for low-noise operation and shows EN (pin 7) connected to IN (pin 8) for an application where enable/shutdown is not required. The error flag is shown with a 47kΩ pull-up resistor.

**Adjustable Regulator Applications**

Figure 3 shows the MIC5206BMM adjustable output voltage configuration. Two resistors set the output voltage. The formula for output voltage is:

$$V_{OUT} = 1.242V \times \left( \frac{R2}{R1} + 1 \right)$$

Resistor values are not critical because ADJ (adjust) has a high input impedance, but for best results use resistors of 470kΩ or less. A capacitor from ADJ to ground provides greatly improved noise performance.

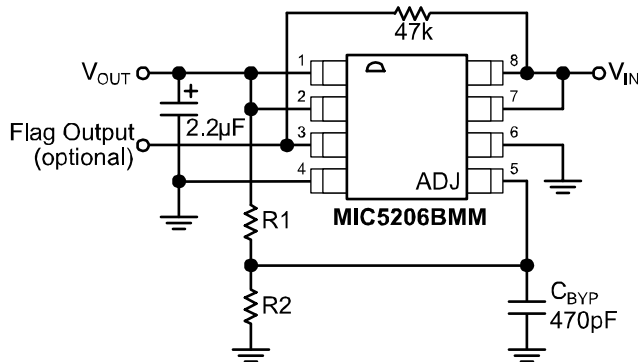

**Figure 3. Ultra-Low-Noise Adjustable Voltage Application**

Figure 3 also includes a 470pF capacitor for lowest-noise operation and shows EN (pin 7) connected to IN (pin 8) for an application where enable/shutdown is not required. C<sub>OUT</sub> = 2.2µF minimum. The error flag is shown with a 47kΩ pull-up resistor.

**Thermal Considerations**

*Layout*

The MIC5206-x.xBM5 (5-pin SOT-23 package) has the following thermal characteristics when mounted on a single layer copper-clad printed circuit board.

Multilayer boards having a ground plane, wide traces near the pads, and large supply bus lines provide better thermal conductivity.

PC Board Dielectric	θ <sub>JA</sub>
FR4	220°C/W
Ceramic	200°C/W

**SOT-23-5 Thermal Characteristics**

The “worst case” value of 220°C/W assumes no ground plane, minimum trace widths, and a FR4 material board.

The MIC5206-xxBMM (8-pin MSOP) has a thermal resistance of 200°C/W when mounted on a FR4 board with minimum trace widths and no ground plane.

PC Board Dielectric	θ <sub>JA</sub>
FR4	200°C

**MSOP Thermal Characteristics**

**Nominal Power Dissipation and Die Temperature**

The MIC5206-x.xBM5 at a 25°C ambient temperature will operate reliably at over 450mW power dissipation when mounted in the “worst case” manner described above. At an ambient temperature of 40°C, the device may safely dissipate over 380mW. These power levels are equivalent to a die temperature of 125°C, the maximum operating junction temperature for the MIC5206.

For additional heat sink characteristics, please refer to Micrel Application Hint 17, “Calculating P.C. Board Heat Sink Area For Surface Mount Packages”.

Package Information

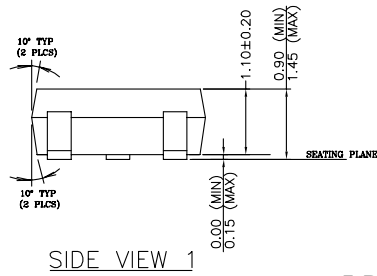
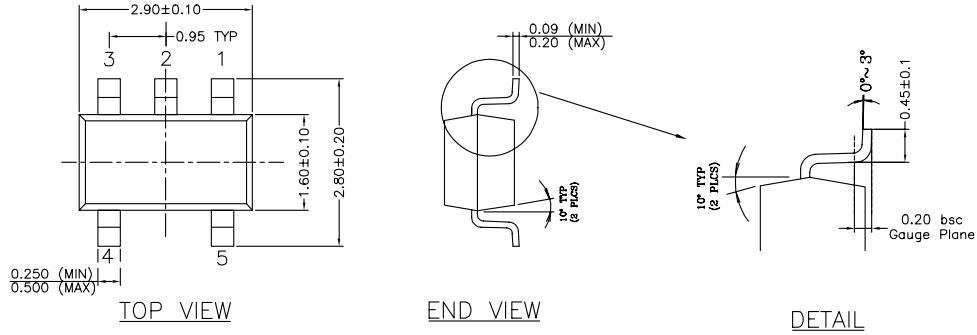

NOTE:  
 1. PACKAGE OUTLINE EXCLUSIVE OF MOLD FLASH & BURR.  
 2. PACKAGE OUTLINE INCLUSIVE OF SOLER PLATING.  
 3. DIMENSION AND TOLERANCE PER ANSI Y14.5M, 1982.  
 4. FOOT LENGTH MEASUREMENT BASED ON GAUGE PLANE METHOD.  
 5. DIE FACES UP FOR MOLD, AND FACES DOWN FOR TRIM/FORM.

5-Pin SOT-23 (M5)

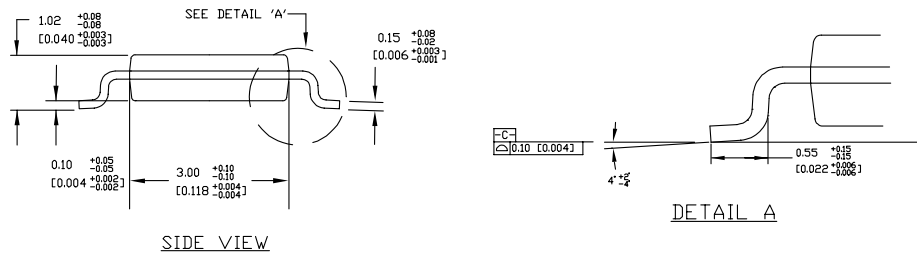
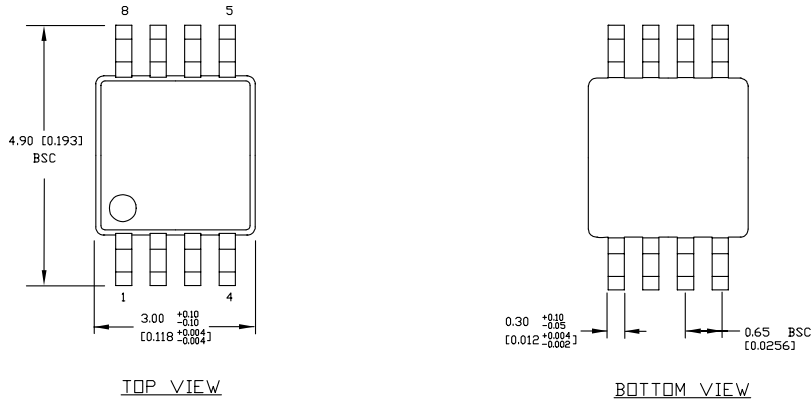

NOTES:  
 1. DIMENSIONS ARE IN MM [INCHES].  
 2. CONTROLLING DIMENSION: MM  
 3. DIMENSION DOES NOT INCLUDE MOLD FLASH OR PROTRUSIONS, EITHER OF WHICH SHALL NOT EXCEED 0.20 [0.008] PER SIDE.

8-Pin MSOP (MM)