

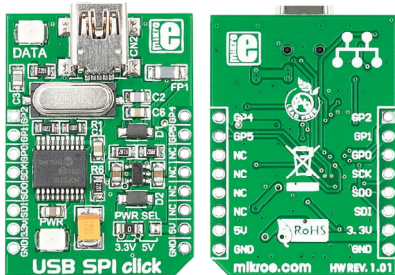

## USB SPI click™

### 1. Introduction



USB SPI click™ is an accessory board in **mikroBUS™** form factor. It's a compact and easy solution for adding SPI serial communication via USB cable. It features **MCP2210** USB-to-SPI protocol converter with GPIO as well as USB MINI B connector. USB SPI click™ communicates with target board via SPI interface as a master device. The board is designed to use 3.3V or 5V power supply. It has a LED diode (GREEN) that indicates the presence of power supply.

### 2. Soldering the headers

Before using your click™ board, make sure to solder 1x8 male headers to both left and right side of the board. Two 1x8 male headers are included with the board in the package.

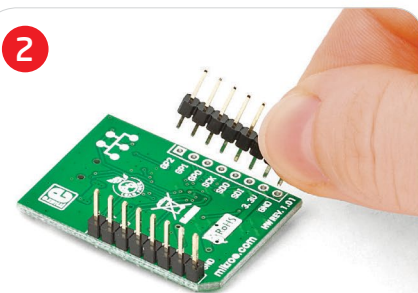
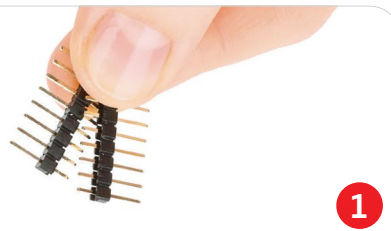

Turn the board upside down so that the bottom side is facing you upwards. Place shorter pins of the header into the appropriate soldering pads.

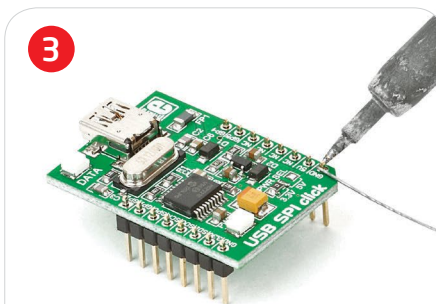

Turn the board upward again. Make sure to align the headers so that they are perpendicular to the board, then solder the pins carefully.

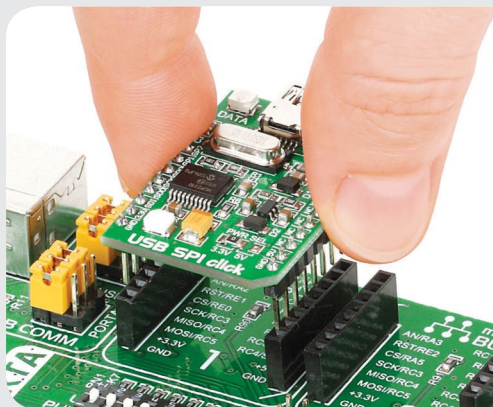

### 3. Plugging the board in

Once you have soldered the headers your board is ready to be placed into the desired mikroBUS™ socket. Make sure to align the cut in the lower-right part of the board with the markings on the silkscreen at the mikroBUS™ socket. If all the pins are aligned correctly, push the board all the way into the socket.

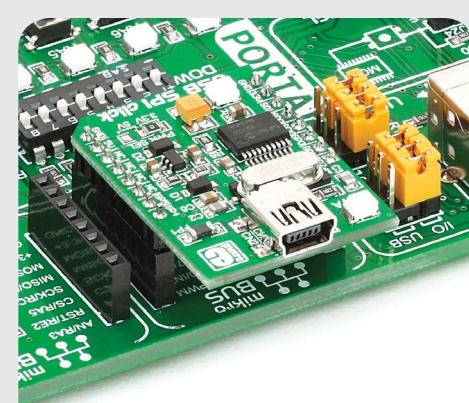

### 4. Essential features

USB SPI click™ with its **MCP2210** IC gives additional SPI serial communication via USB cable. The **MCP2210** IC contains 256 Bytes of user EEPROM, 128 Byte buffer to handle data (64 byte transmit and 64-byte receive) and nine general purpose I/O pins. The board contains 12 MHz crystal oscillator which provides external clock waveform for **MCP2210** IC as well as a LED diode which indicates SPI traffic.

click™  
BOARD  
[www.mikroe.com](http://www.mikroe.com)

USB SPI click™ Manual  
ver. 1.01a



0 10000 026618

## 5. USB SPI click™ board schematic

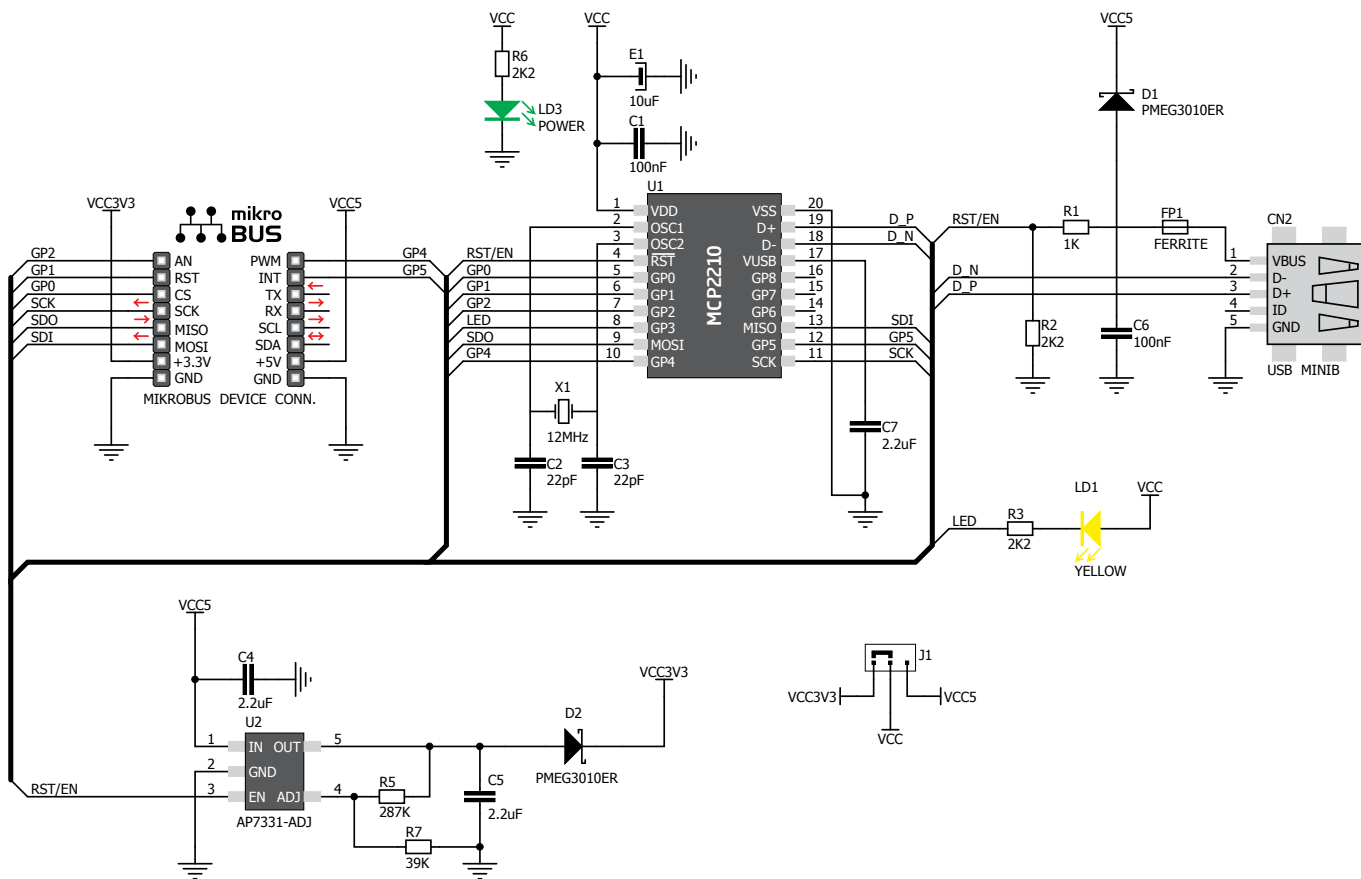

## 6. SMD jumper

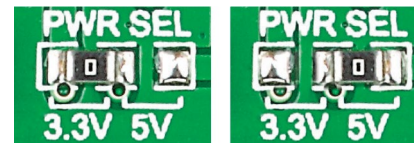

There is one zero-ohm SMD jumper **J1** which is used to select whether 3.3V or 5V power supply is used. Jumper **J1** is soldered in 3.3V position by default.

## 7. Code examples

Once you have done all the necessary preparations, it's time to get your click™ board up and running. We have provided examples for mikroC™, mikroBasic™ and mikroPascal™ compilers on our **Libstock** website. Just download them and you are ready to start.



## 8. Support

MikroElektronika offers **free tech support** ([www.mikroe.com/support](http://www.mikroe.com/support)) until the end of the product's lifetime, so if something goes wrong, we're ready and willing to help!