

# mikroProg™

## for 8051

mikroProg™ for 8051 is a fast USB programmer. With it's outstanding performance, simplicity and unique design it is a great tool for programming 8051 microcontrollers from Atmel®





# TO OUR VALUED CUSTOMERS

I want to express my thanks to you for being interested in our products and for having confidence in MikroElektronika.

The primary aim of our company is to design and produce high quality electronic products and to constantly improve the performance thereof in order to better suit your needs.



Nebojsa Matic  
General Manager



# Table of Contents

Introduction to mikroProg™	6	2. Connecting to a PC	11
Key features	7	3. 8051Flash software	12
1. Driver installation	8	4. Connecting with a target device	14
step 1 - Start installation	9	5. Connector Pinout	15
step 2 - Accept EULA	9	6. Connection schematic example	16
step 3 - Installing the drivers	10	40-pin AT89S8253 schematic	17
step 4 - Finish installation	10		

# Introduction to mikroProg™

mikroProg™ for 8051 is a fast USB programmer. It is a great tool for programming 8051 microcontrollers from Atmel®. Outstanding performance, easy operation, elegant design and low price are its top features.



# Key features

## What you see

- 01 Flat cable
- 02 USB MINIB connector
- 03 DATA transfer indication LED
- 04 ACTIVE indication LED
- 05 LINK indication LED
- 06 POWER indication LED



# 1. Driver installation

On-board mikroProg™ requires drivers in order to work.  
Drivers can be found on the link below:

➔ [www.mikroe.com/downloads/get/131/mikroprog\\_drivers\\_v200.zip](http://www.mikroe.com/downloads/get/131/mikroprog_drivers_v200.zip)

When you download the drivers, please extract files from the ZIP archive. Folder with extracted files contains folders with drivers for different operating systems. Depending on which operating system you use, choose adequate folder and open it.



mikroprog\_drivers\_v200.zip  
WinRAR ZIP archive



Win 98



Win 2000, XP,  
2003 32-bit



Win XP, 2003  
64-bit



Windows (32 bit)  
- Vista, Win 2008,  
7, 8, 8.1



Windows (64 bit)  
- Vista, Win 2008,  
7, 8, 8.1

In the opened folder you should be able to locate the driver setup file. Double click on setup file to begin installation of the programmer drivers.



USB18PRG-Vista-x64.EXE



## step 1 - Start installation

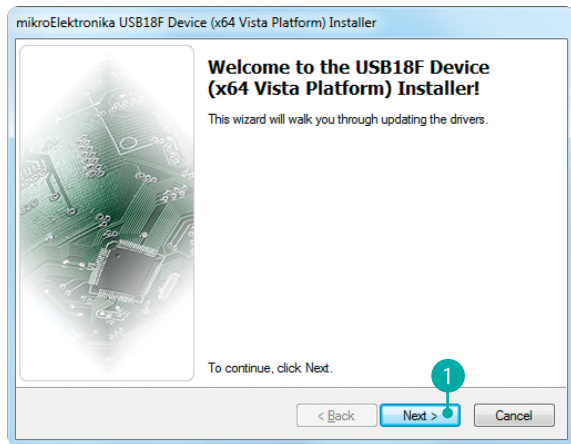

- 1 In welcome screen click the **Next>** button

## step 2 - Accept EULA

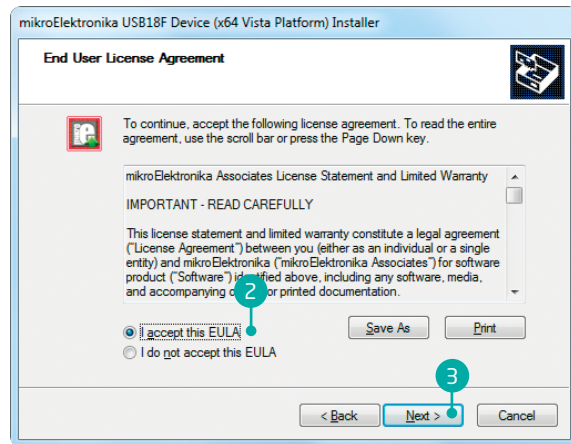

- 2 Select **I accept this EULA** option
- 3 Click the **Next>** button

## step 3 - Installing the drivers

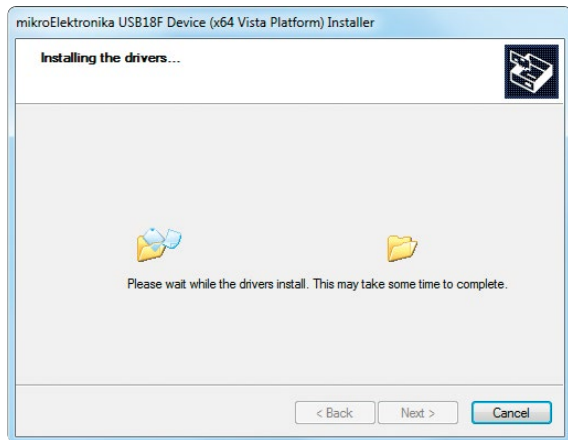

## step 4 - Finish installation

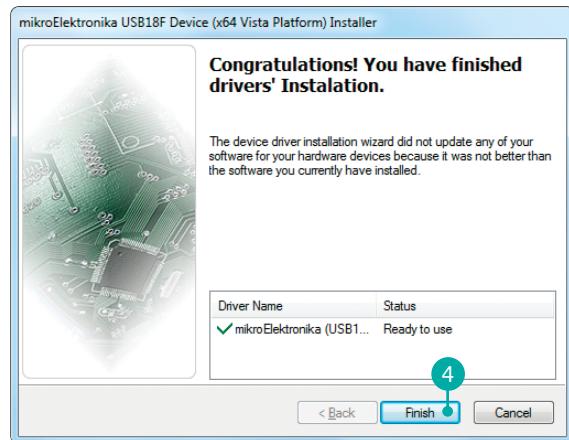

- 4 Click the **Finish** button to end installation process

## 2. Connecting to a PC

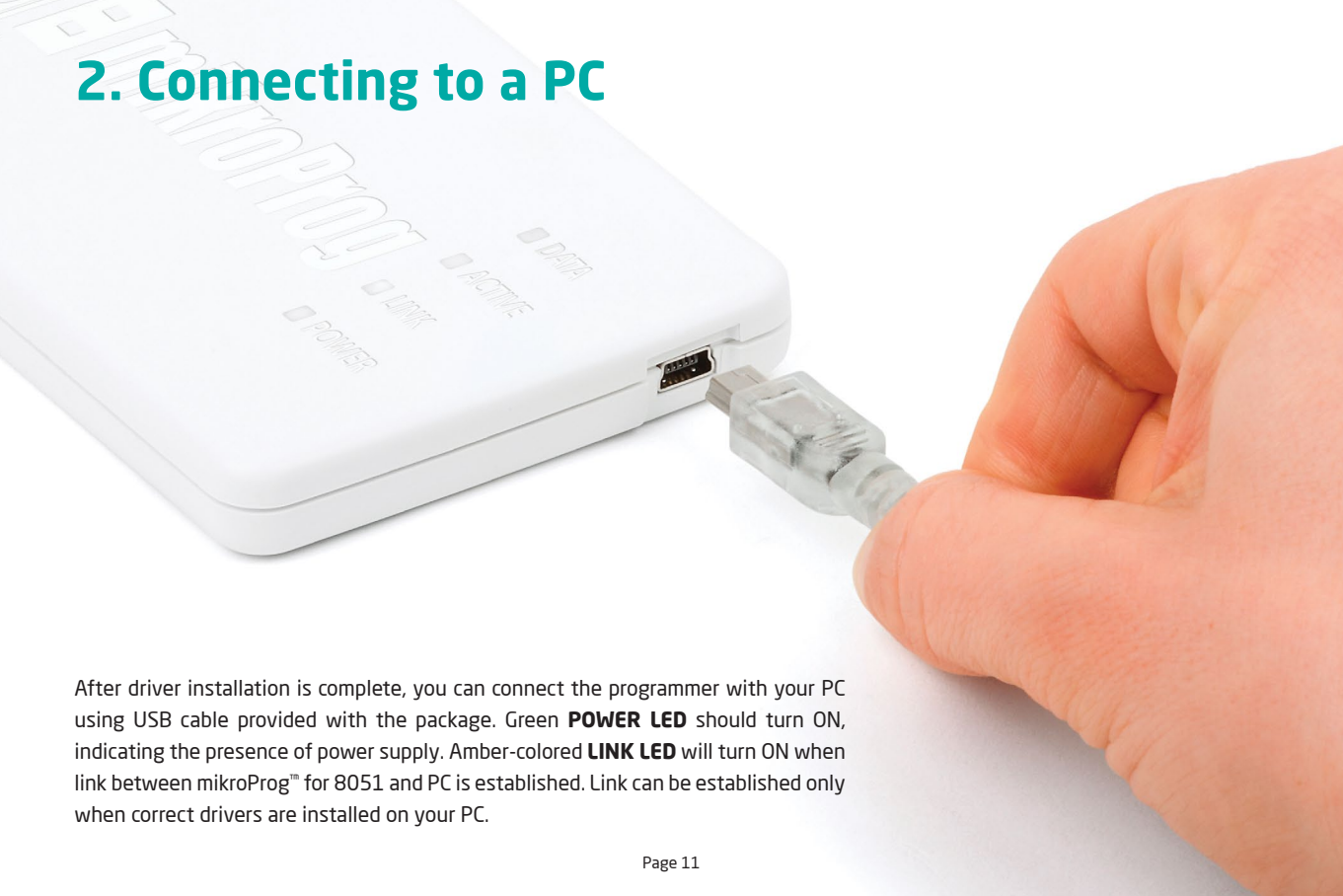

After driver installation is complete, you can connect the programmer with your PC using USB cable provided with the package. Green **POWER LED** should turn ON, indicating the presence of power supply. Amber-colored **LINK LED** will turn ON when link between mikroProg™ for 8051 and PC is established. Link can be established only when correct drivers are installed on your PC.

# 3. 8051Flash software

mikroProg™ for 8051 programmer requires special programming software called 8051Flash. This software is used for programming ALL of 8051 microcontrollers from Atmel®. It features intuitive interface and SingleClick™ programming technology. Software installation is available on the following link:

[www.mikroe.com/downloads/get/130/8051flash\\_programmer\\_v210.zip](http://www.mikroe.com/downloads/get/130/8051flash_programmer_v210.zip)

After downloading, extract the package and double click the executable setup file, to start installation.

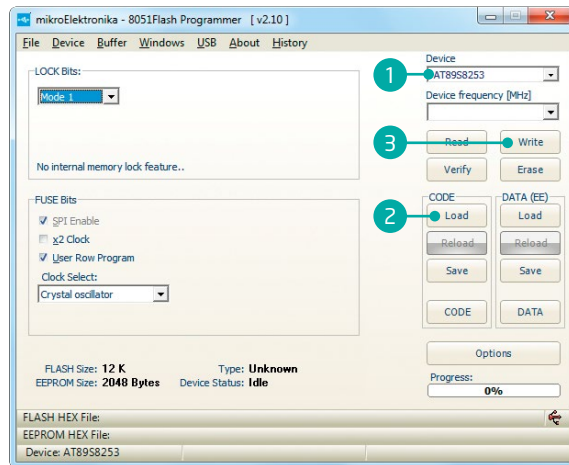
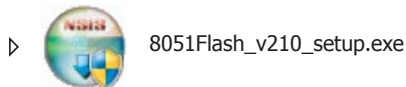
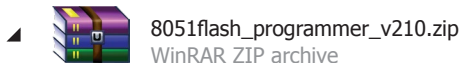

Figure 3-1: 8051Flash software window

## Quick Guide

- 1 Select the microcontroller to be programmed
- 2 Click the **Load** button to open pop-up window and select the .hex code to be loaded in microcontroller
- 3 Click the **Write** option to start programming

# Software installation wizard



1 Start Installation

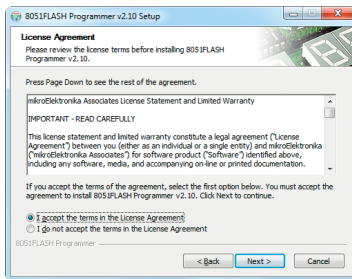

2 Accept EULA and continue

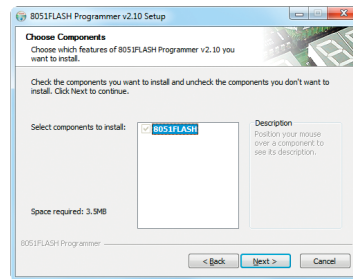

3 Click Next > button

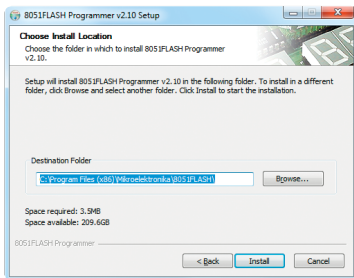

4 Choose destination folder

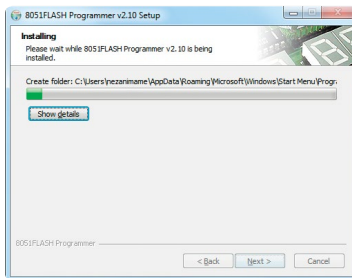

5 Installation in progress



6 Finish installation

# 4. Connecting with a target device

Figure 4-1:  
IDC10 JTAG  
connector

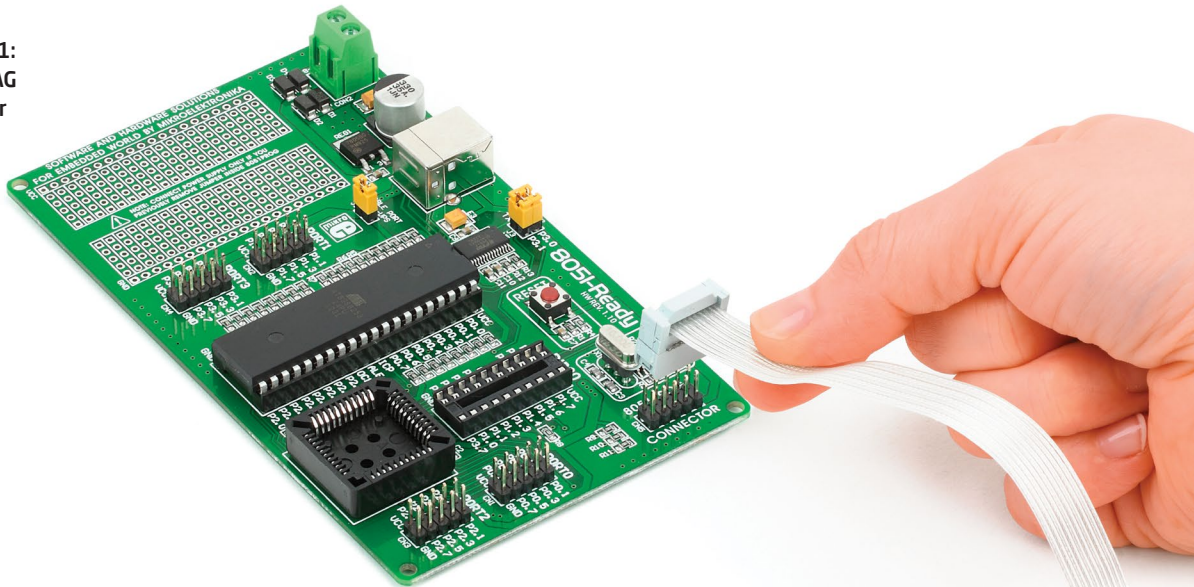

For connection with a target device mikroProg™ uses IDC10 connector, as shown on **Figure 4-1**. In order to make proper connection with the target board it is necessary to pay attention

to IDC10 connector pinout. Every pin has a different purpose and for easy orientation IDC10 connector is marked with a little knob and incision between pins number 9 and 7, **Figure 5-1**.

# 5. Connector Pinout

- 1 **MOSI** - Master output slave input
- 3 **NC** - Not connected
- 5 **RST** - Reset pin
- 7 **SCK** - Clock
- 9 **MISO** - Master input slave output
  
- 2 **VCC** - Power supply
- 4 **SS** - Slave port select
- 6 **NC** - Not connected
- 8 **NC** - Not connected
- 10 **GND** - Ground

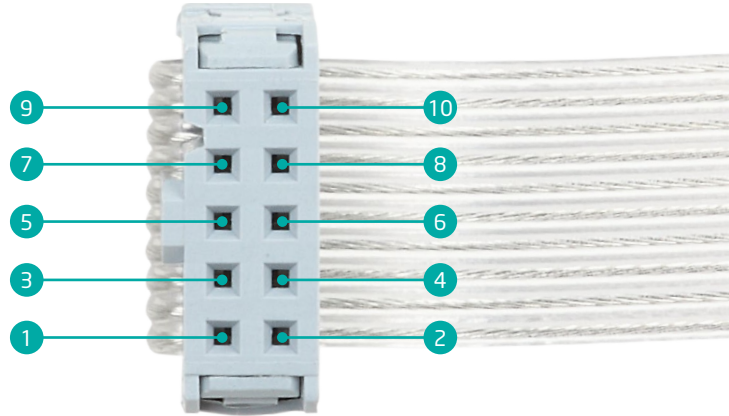
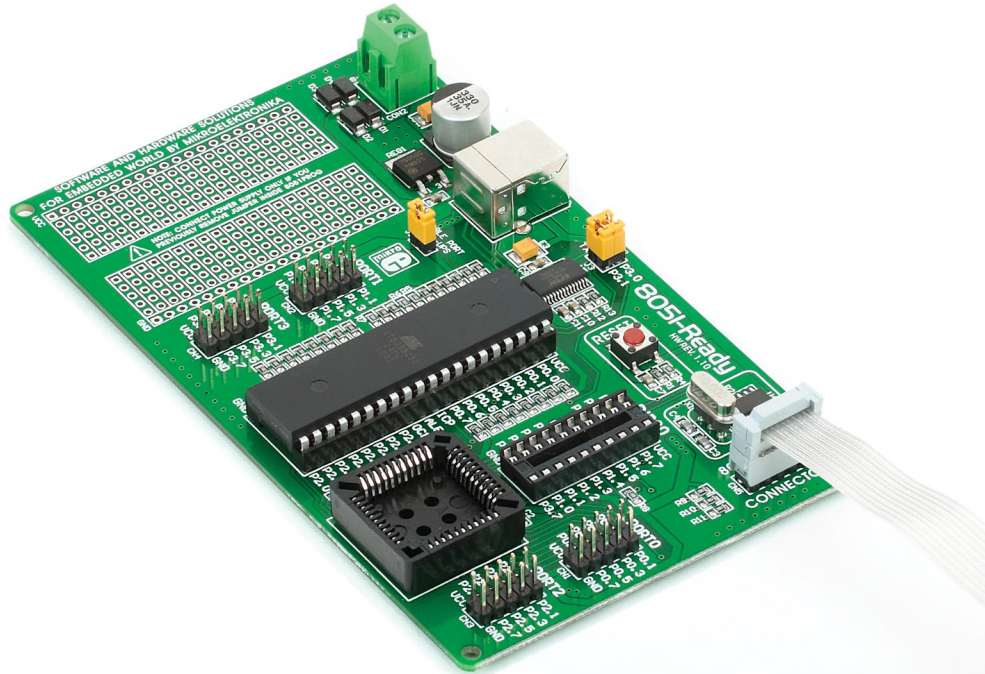

Figure 5-1: Female connector pinout

## 6. Connection schematic example

Following example demonstrate connections with one of the most popular supported microcontroller (**Figure 6-1**). MCU use MISO, MOSI, SCK, RST and SS lines for programming. In order for microcontroller to work properly, decoupling capacitors must be connected as close as possible to microcontroller's VCC pins. Whichever microcontroller you decide to use, make sure to connect each pin properly.





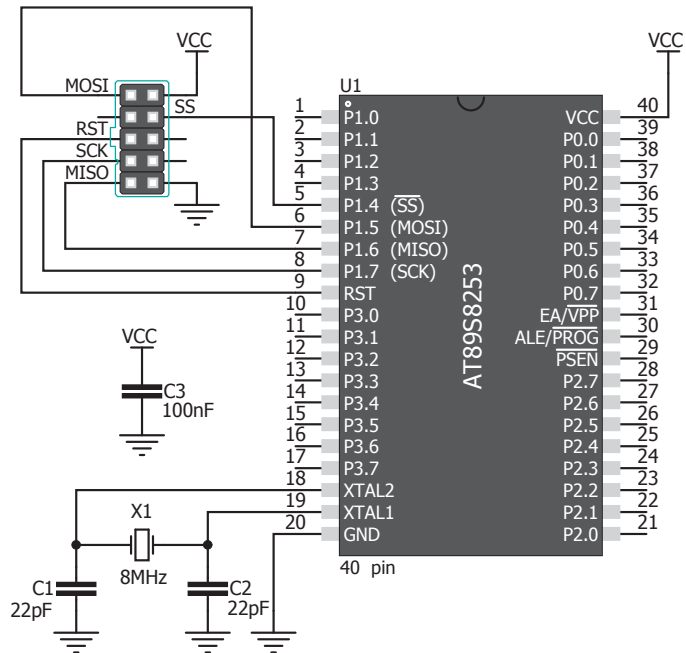

Figure 6-1: Connection schematic for 40-pin AT89S8253 MCU via 2x5 male header



## DISCLAIMER

All the products owned by MikroElektronika are protected by copyright law and international copyright treaty. Therefore, this manual is to be treated as any other copyright material. No part of this manual, including product and software described herein, may be reproduced, stored in a retrieval system, translated or transmitted in any form or by any means, without the prior written permission of MikroElektronika. The manual PDF edition can be printed for private or local use, but not for distribution. Any modification of this manual is prohibited.

MikroElektronika provides this manual 'as is' without warranty of any kind, either expressed or implied, including, but not limited to, the implied warranties or conditions of merchantability or fitness for a particular purpose.

MikroElektronika shall assume no responsibility or liability for any errors, omissions and inaccuracies that may appear in this manual. In no event shall MikroElektronika, its directors, officers, employees or distributors be liable for any indirect, specific, incidental or consequential damages (including damages for loss of business profits and business information, business interruption or any other pecuniary loss) arising out of the use of this manual or product, even if MikroElektronika has been advised of the possibility of such damages. MikroElektronika reserves the right to change information contained in this manual at any time without prior notice, if necessary.

### HIGH RISK ACTIVITIES

The products of MikroElektronika are not fault - tolerant nor designed, manufactured or intended for use or resale as on - line control equipment in hazardous environments requiring fail - safe performance, such as in the operation of nuclear facilities, aircraft navigation or communication systems, air traffic control, direct life support machines or weapons systems in which the failure of Software could lead directly to death, personal injury or severe physical or environmental damage ('High Risk Activities'). MikroElektronika and its suppliers specifically disclaim any expressed or implied warranty of fitness for High Risk Activities.

## TRADEMARKS

The MikroElektronika name and logo, mikroC™, mikroBasic™, mikroPascal™, Visual TFT™, Visual GLCD™, mikroProg™, Ready™, MINI™, mikroBUS™, EasyPIC™, EasyAVR™, Easy8051™, click™ boards and mikromedia™ are trademarks of MikroElektronika. All other trademarks mentioned herein are property of their respective companies. All other product and corporate names appearing in this manual may or may not be registered trademarks or copyrights of their respective companies, and are only used for identification or explanation and to the owners' benefit, with no intent to infringe.

Windows® logos and product names are trademarks of Microsoft® in the U.S.A. and other countries.

Copyright © 2014 MikroElektronika. All Rights Reserved.