

FTDI click™

1. Introduction

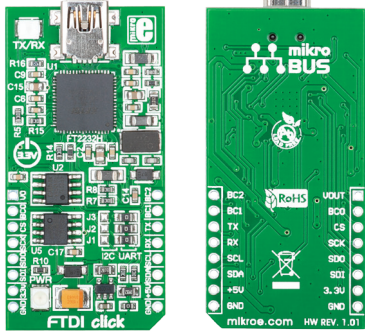

FTDI Click™ is an accessory board in **mikroBUS™** form factor. It's a compact and easy solution for adding USB to UART/SPI/I²C communication to your design. It features **FT2232H** dual high speed USB to multipurpose IC, DA converter as well as EEPROM. FTDI Click™ communicates with the target board microcontroller via **mikroBUS™** SPI (MOSI, MISO, SCK, CS), I²C (SDA, SCL), UART (Tx, Rx), RST, PWM, AN and INT lines. LED diode (GREEN) indicates the presence of power supply.

2. Soldering the headers

Before using your click board™, make sure to solder 1x8 male headers to both left and right side of the board. Two 1x8 male headers are included with the board in the package.

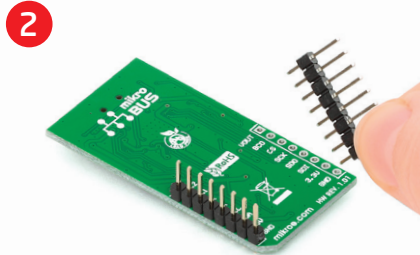
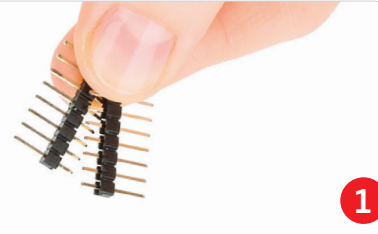

Turn the board upside down so that bottom side is facing you upwards. Place shorter parts of the header pins in both soldering pad locations.

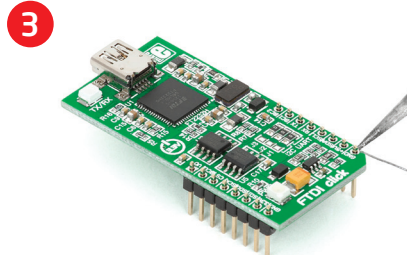

Turn the board upward again. Make sure to align the headers so that they are perpendicular to the board, then solder the pins carefully.

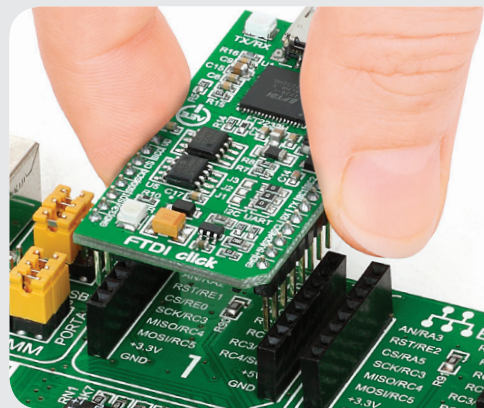

3. Plugging the board in

Once you have soldered the headers your board is ready to be placed into desired mikroBUS™ socket. Make sure to align the cut in the lower-right part of the board with the markings on the silkscreen at the mikroBUS™ socket. If all of the pins are aligned correctly, push the board all the way into the socket.

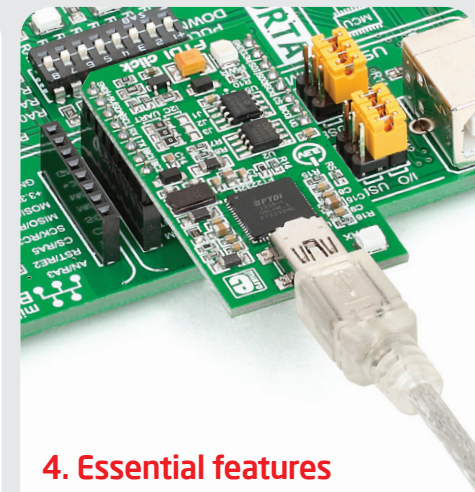

4. Essential features

FTDI Click™ with its **FT2232H** IC is a dual high speed USB 2.0 to UART/SPI/I²C serial interfaces converter. The entire USB protocol is handled on the chip (USB drivers from FTDI are required). The board can be powered by USB cable or directly from mikroBUS socket. It is ideal for USB applications (smart card readers, instrumentation, industrial control, MP3 player interface, digital camera interface, bar code readers) and many more.

click™
BOARD
www.mikroe.com

FTDI click Manual
ver. 1.01



0 100000 023747

5. FTDI Click™ Board Schematic

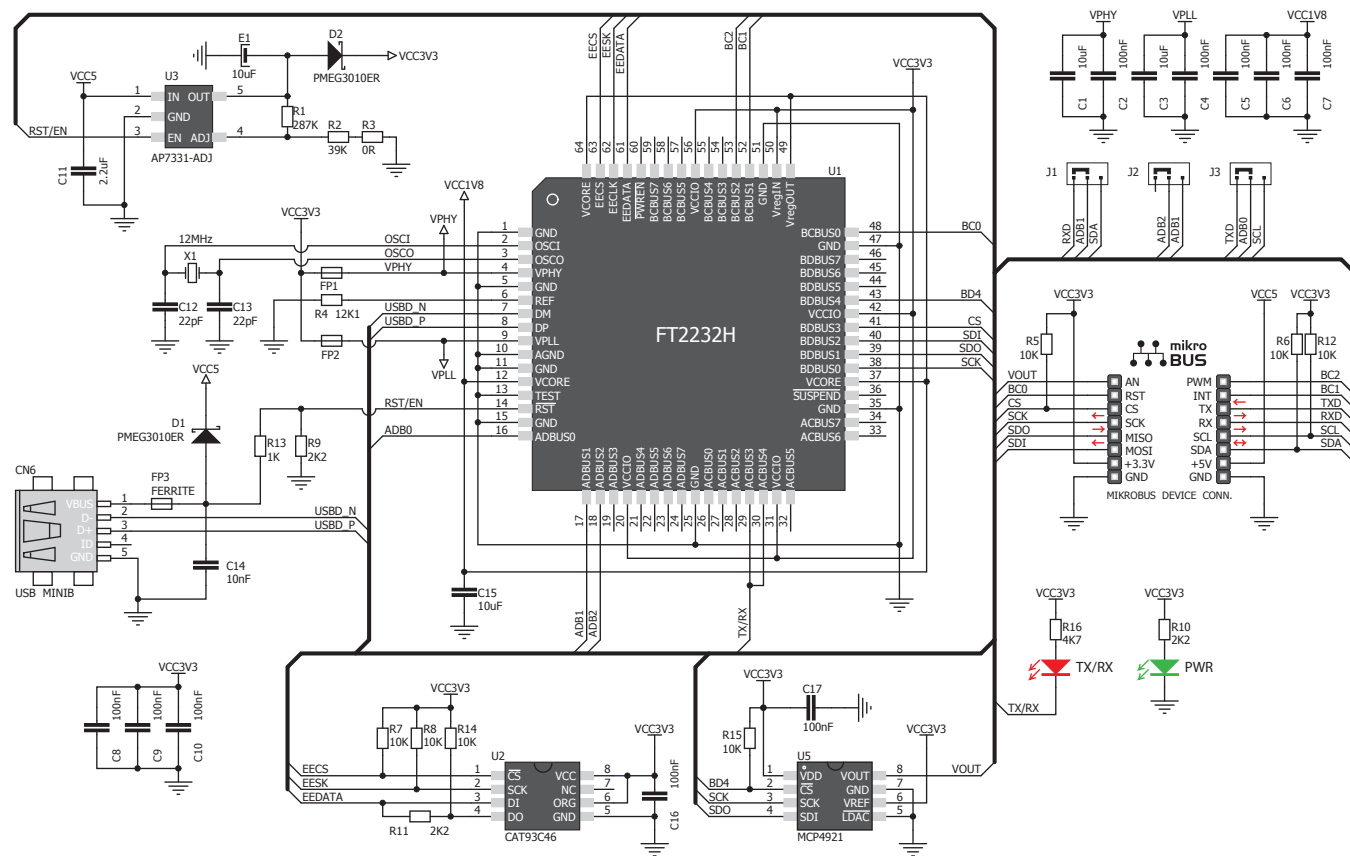

6. SMD Jumpers

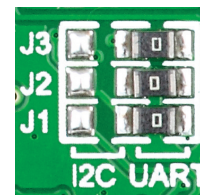

The FTDI Click™ board communicates with the main board microcontroller via I²C or UART interface depending on the position of the **J1**,

J2 and **J3** SMD jumpers. These jumpers are soldered in UART position by default.

7. Code Examples

Once you have done all the necessary preparations, it's time to get your click board up and running. We have provided the examples for mikroC, mikroBasic and mikroPascal compilers on our **Libstock** website. Just download them and you are ready to start.



8. Support

MikroElektronika offers **Free Tech Support** (www.mikroe.com/esupport) until the end of product lifetime, so if something goes wrong, we are ready and willing to help!