

## DC MOTOR click™

### 1. Introduction

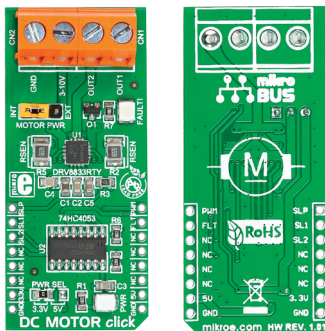

DC MOTOR click™ is a DC motor driver board in mikroBUS™ form factor. It features the **DRV8833RTY** H-Bridge motor driver, **74HC4053** multiplexer and two screw terminals. DC MOTOR click™ communicates with the target board via SELECT1, SELECT2 and nSLEEP control lines, PWM input line and nFAULT feedback line. The board is designed to use 3.3V or 5V power supplies. It has a GREEN power supply indicator LED and a RED LED that indicates active nFAULT line (in case of short-circuit).

### 2. Soldering the headers

Before using your click™ board, make sure to solder 1x8 male headers to both left and right side of the board. Two 1x8 male headers are included with the board in the package.



1

2

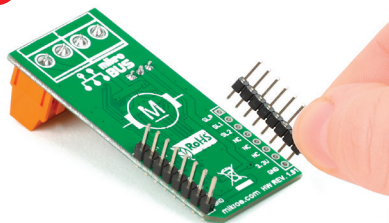

Turn the board upside down so that the bottom side is facing you upwards. Place shorter pins of the header into the appropriate soldering pads.

3

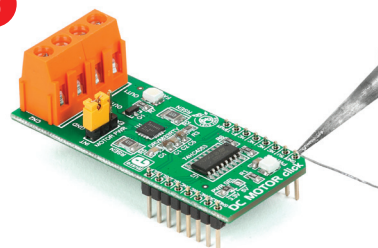

Turn the board upward again. Make sure to align the headers so that they are perpendicular to the board, then solder the pins carefully.

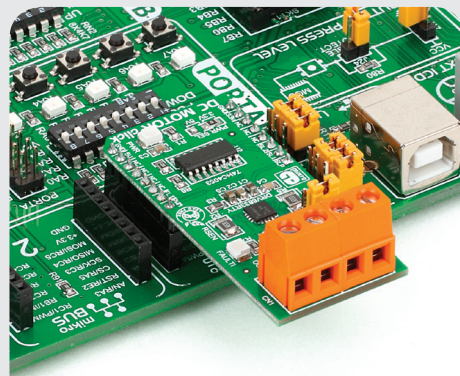

### 4. Essential features

DC MOTOR click™ with its **DRV8833RTY** IC's is limited to a 0.9A driving current with 0.22Ω current sense resistor. The 74HC4053 IC is incorporated into the design in order to run the motor with only one PWM line available on the mikroBUS™ socket. Use jumper **J2** to select whether you want to power the board with the on-board or external power supply connected to the **CN2** screw terminal. The motor should be connected to the **CN1** screw terminal.

### 3. Plugging the board in

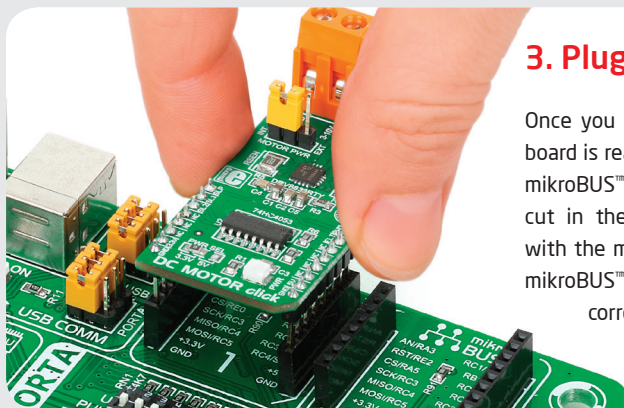

Once you have soldered the headers your board is ready to be placed into the desired mikroBUS™ socket. Make sure to align the cut in the lower-right part of the board with the markings on the silkscreen at the mikroBUS™ socket. If all the pins are aligned correctly, push the board all the way into the socket.

click™  
BOARD  
www.mikroe.com



DC Motor click Manual  
ver. 1.01



## 5. DC MOTOR click™ Board Schematic

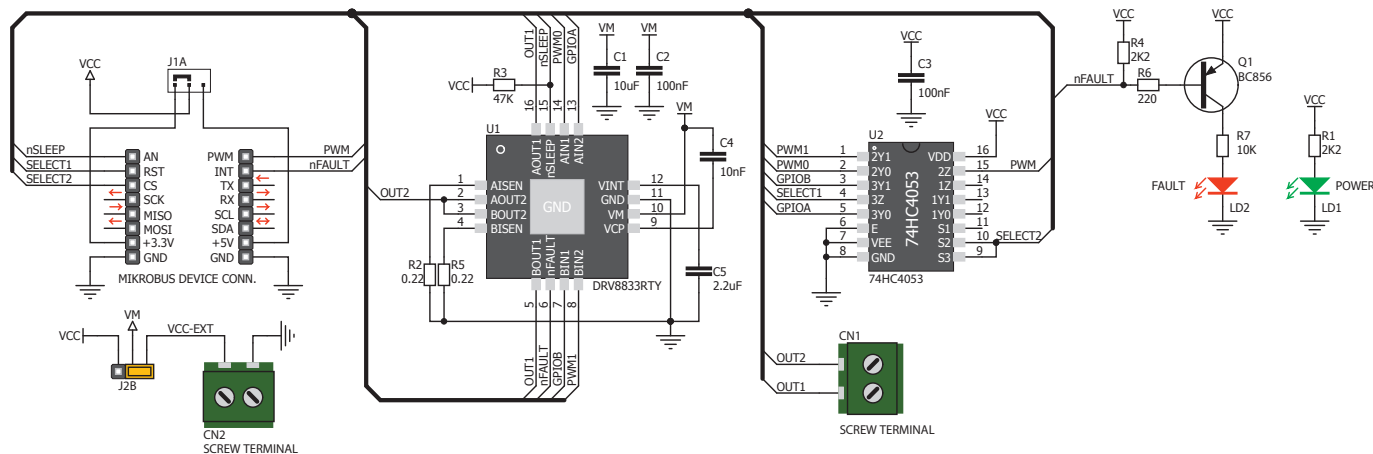

With two control lines SELECT1, SELECT2 and PWM input you can choose from the following driving options described in the table:

SELECT1	SELECT2	PwM	ROTATION	SPEED	BRAKE	DECAY
0	0	0-100%	Forward	MIN-MAX	@ 0% PWM	Fast
0	1	0-100%	Reverse	MIN-MAX	@ 0% PWM	Fast
1	0	0-100%	Reverse	MAX-MIN	@ 100% PwM	Slow
1	1	0-100%	Forward	MAX-MIN	@ 100% PwM	Slow

MikroElektronika assumes no responsibility or liability for any errors or inaccuracies that may appear in the present document. Specification and information contained in the present schematic are subject to change at any time without notice. Copyright © 2014 MikroElektronika. All rights reserved.

## 6. SMD Jumpers

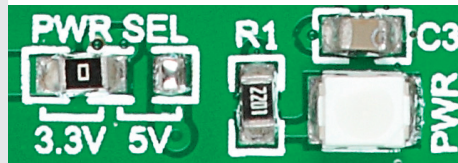

There is a single SMD jumper (zero-ohm resistor) **J1** which is used to select between 3.3V or 5V power supplies. By default, it's soldered in the 3.3V position.

## 7. Code Examples

Once you have done all the necessary preparations, it's time to get your click™ board up and running. We have provided examples for mikroC™, mikroBasic™ and mikroPascal™ compilers on our **Libstock** website. Just download them and you are ready to start.



## 8. Support

MikroElektronika offers **Free Tech Support** ([www.mikroe.com/support/](http://www.mikroe.com/support/)) until the end of the product's lifetime, so if something goes wrong, we're ready and willing to help!

