

Hall current click™

1. Introduction

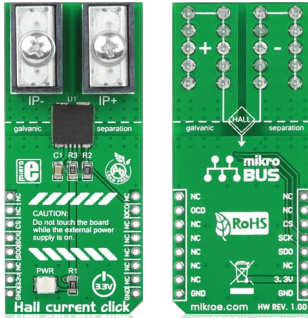

Hall current click™ is a high precision current sensor. It carries a galvanically isolated TLI4970-D050T4 miniature magnetic digital current sensor that utilizes the Hall effect to measure electric current. The board carries two EXtreme ZPower connectors to connect the conductor. The sensor readings are sent to the target board through the mikroBUS™ SPI (SDO, SCK, and CS) lines. The board uses a 3.3V power supply only.

2. Soldering the headers

Before using your click™ board, make sure to solder 1x8 male headers to both left and right side of the board. Two 1x8 male headers are included with the board in the package.

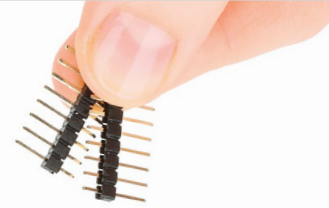

1

2

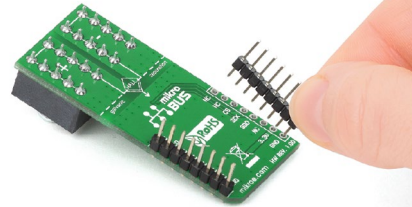

Turn the board upside down so that the bottom side is facing you upwards. Place shorter pins of the header into the appropriate soldering pads.

3

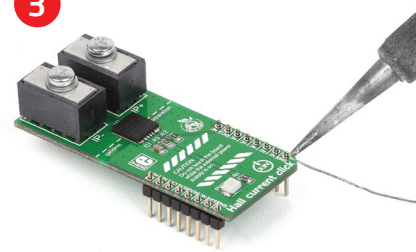

Turn the board upward again. Make sure to align the headers so that they are perpendicular to the board, then solder the pins carefully.

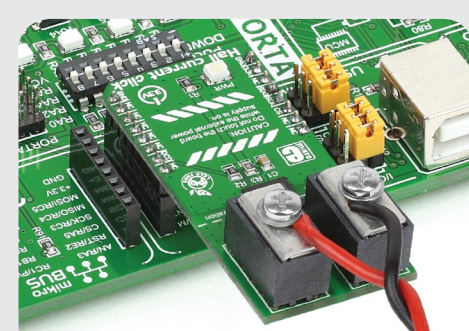

4. Essential features

Hall current click™ is a contact-free current measurement device. To measure the current, connect the conductor to two ZPower connectors (IP- and IP+). The current rail is galvanically isolated from the interface to the microcontroller keeping the surrounding circuitry safe. The signal has a 16-bit internal resolution. Hall click is perfectly suited for systems with high efficiency because the contact-free measurement principle causes no additional power loss. Consult the TLI4970-D050T4 IC data-sheet for more information.

3. Plugging the board in

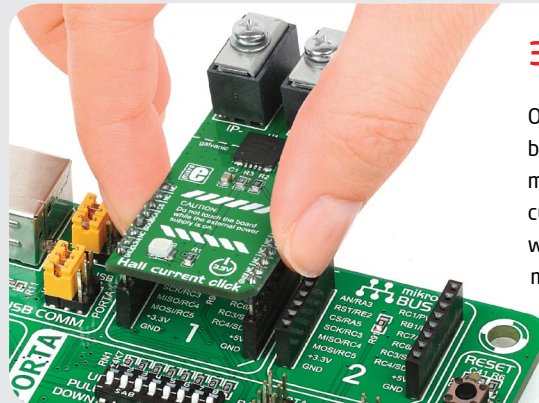

Once you have soldered the headers your board is ready to be placed into the desired mikroBUS™ socket. Make sure to align the cut in the lower-right part of the board with the markings on the silkscreen at the mikroBUS™ socket. If all the pins are aligned correctly, push the board all the way into the socket.



Hall current click Manual
ver. 1.00a



5. Hall current click™ board schematic

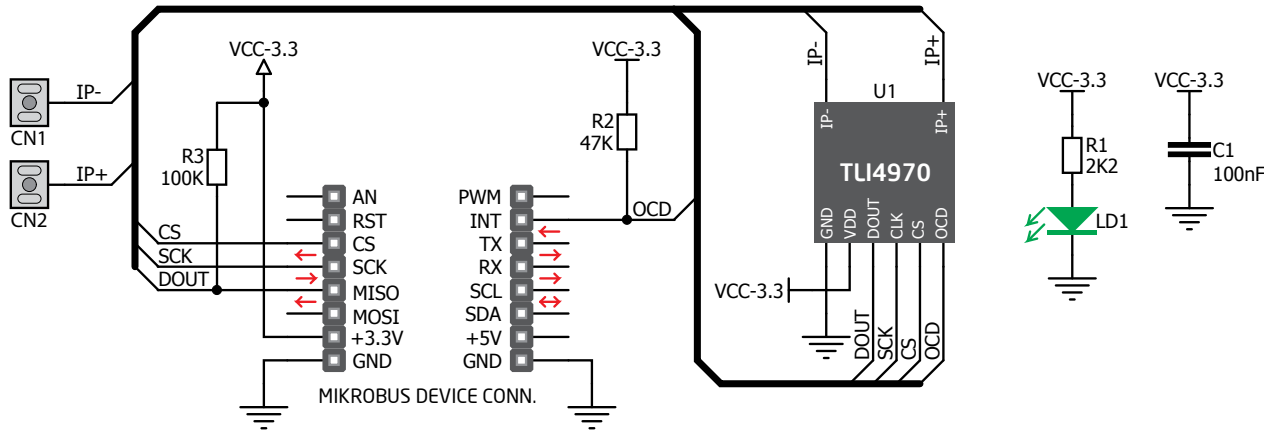

6. DANGER



WARNING: DO NOT TOUCH THE BOARD WHILE THE EXTERNAL POWER SUPPLY IS ON!

7. Code examples

Once you have done all the necessary preparations, it's time to get your click™ board up and running. We have provided examples for mikroC™, mikroBasic™ and mikroPascal™ compilers on our **Libstock** website. Just download them and you are ready to start.



8. Support

MikroElektronika offers **free tech support** (www.mikroe.com/support/) until the end of the product's lifetime, so if something goes wrong, we're ready and willing to help!