

ccRF2 click™

1. Introduction

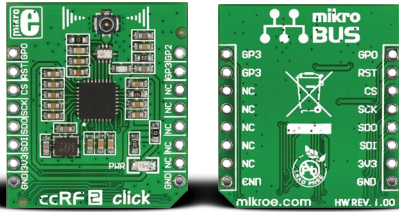

ccRF2 click™ will enable you to add a high performance, low power consumption single-chip radio transceiver to your design. It carries **CC1120**, the fully integrated radio transceiver designed mainly the ISM (Industrial, Scientific, and Medical) and SRD (Short Range Device) frequency bands at 164-192 MHz, 274-320 MHz, 410-480 MHz, and 820-960 MHz. ccRF2 click™ communicates with the target board through mikroBUS™ SPI (MISO, MOSI, CSK), and AN, RST, CS, PWM and INT lines. The board uses a 3.3V power supply only.

2. Soldering the headers

Before using your click™ board, make sure to solder 1x8 male headers to both left and right side of the board. Two 1x8 male headers are included with the board in the package.

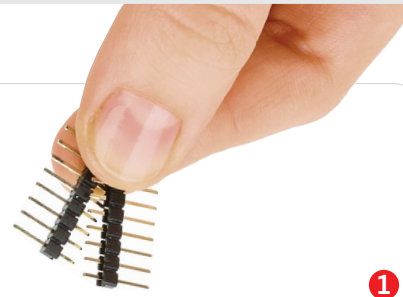

1

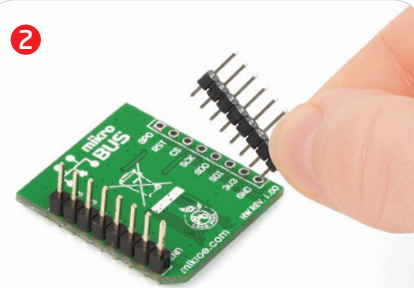

Turn the board upside down so that the bottom side is facing you upwards. Place shorter pins of the header into the appropriate soldering pads.

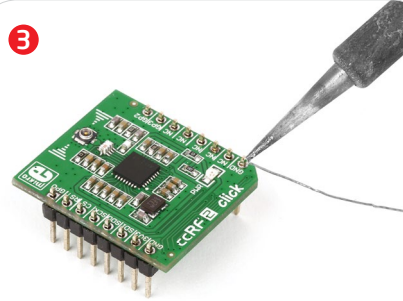

Turn the board upward again. Make sure to align the headers so that they are perpendicular to the board, then solder the pins carefully.

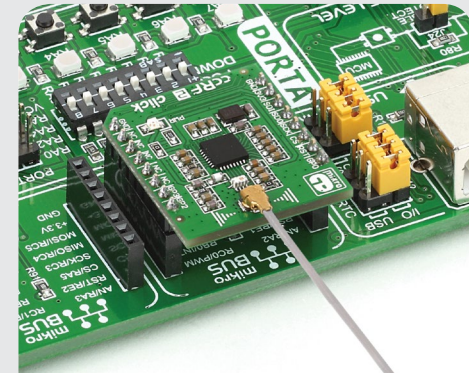

4. Essential features

The **CC1120** IC on ccRF2 click™ provides **extensive hardware support** for packet handling, data buffering, burst transmissions, clear channel assessment, link quality indication, and Wake-On-Radio. CC1120 also integrates all filters, which removes the need for costly external SAW and IF filters. It's a great solution for wireless communications in home and building automation as well as industrial monitoring and control.

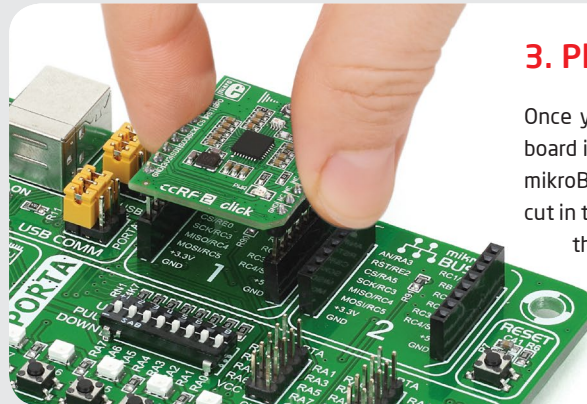

3. Plugging the board in

Once you have soldered the headers your board is ready to be placed into the desired mikroBUS™ socket. Make sure to align the cut in the lower-right part of the board with the markings on the silkscreen at the mikroBUS™ socket. If all the pins are aligned correctly, push the board all the way into the socket.

click™
BOARD
www.mikroe.com

ccRF2 click™ manual
ver. 1.00



0 100000 027554

5. ccRF2 click™ board schematic

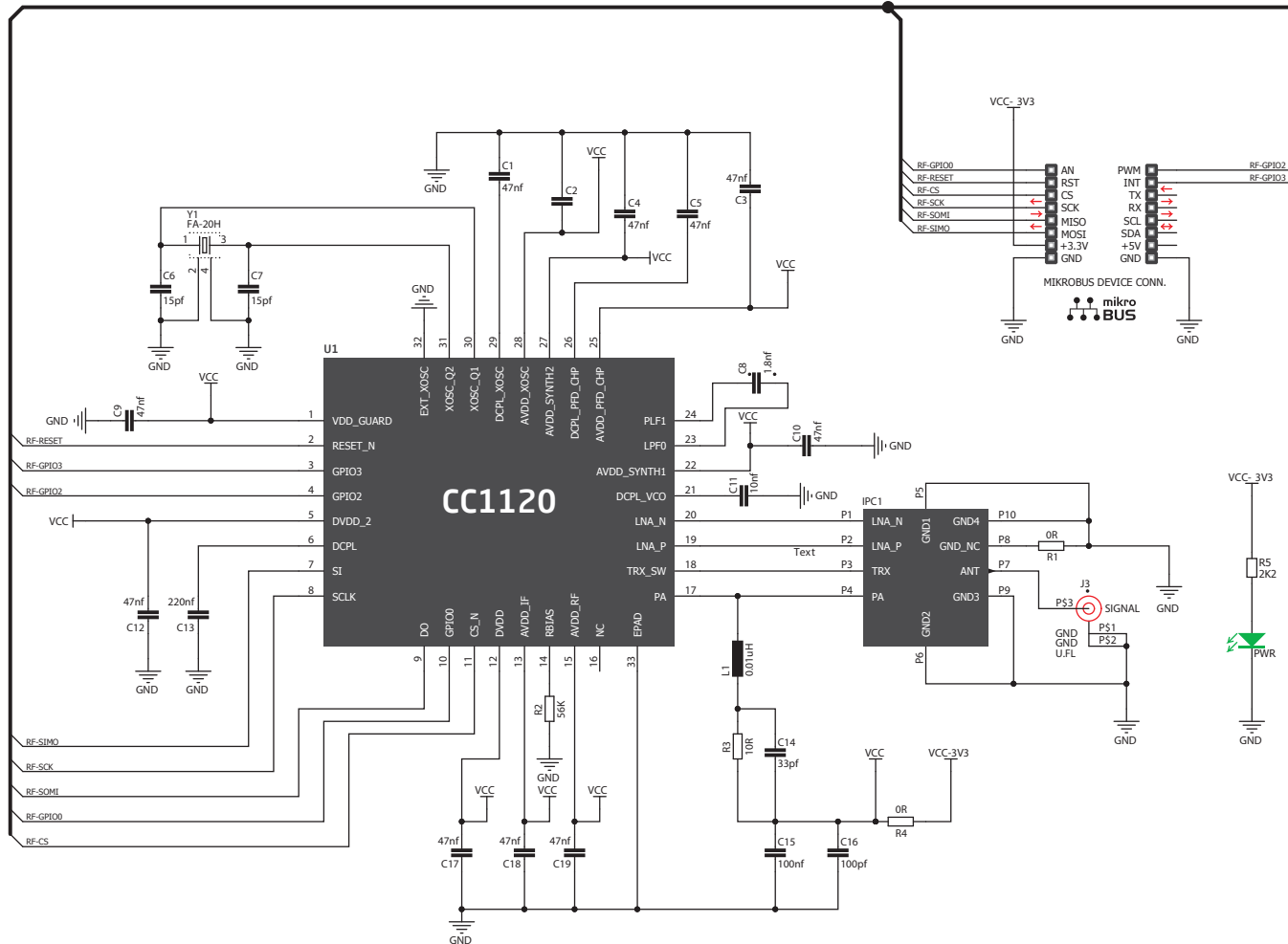

6. External antenna connector

To use ccRF2 click™ you'll need to connect an external antenna to the N.F.L Series Coaxial Connector. To get one, search for "antenna" at www.mikroe.com/store

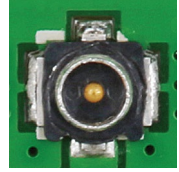

7. Code examples

Once you have done all the necessary preparations, it's time to get your click™ board up and running. We have provided examples for mikroC™, mikroBasic™ and mikroPascal™ compilers on our **Libstock** website. Just download them and you are ready to start.



8. Support

MikroElektronika offers **free tech support** (www.mikroe.com/support) until the end of the product's lifetime, so if something goes wrong, we're ready and willing to help!