

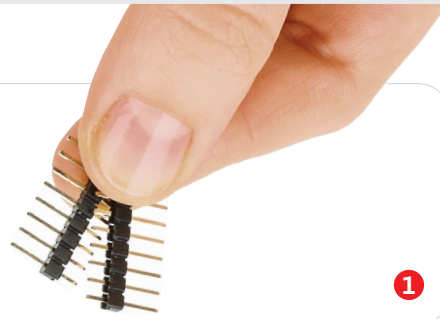

## ETH WIZ click™

### 2. Soldering the headers

Before using your click™ board, make sure to solder 1x8 male headers to both left and right side of the board. Two 1x8 male headers are included with the board in the package.



1

2

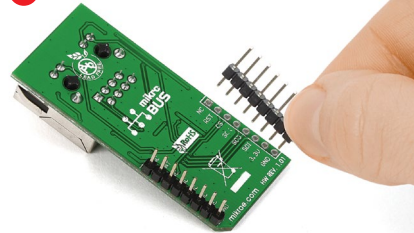

Turn the board upside down so that the bottom side is facing you upwards. Place shorter pins of the header into the appropriate soldering pads.

3

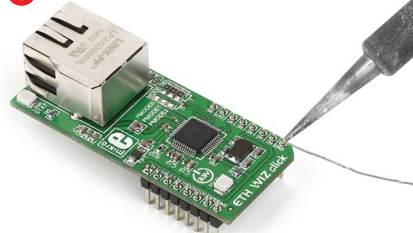

Turn the board upward again. Make sure to align the headers so that they are perpendicular to the board, then solder the pins carefully.

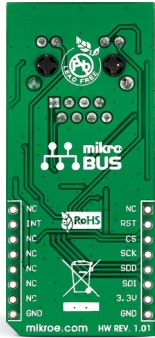

### 1. Introduction

ETH Wiz click™ carries **W5500**, a 48-pin, 10/100 BASE-TX standalone Ethernet controller with a hardwired TCP/IP Internet protocol offload engine, along with a standard **RJ-45 connector**. Wiznet's W5500 module supports TCP, UDP, IPv4, ICMP, ARP, IGMP, and PPPoE protocols. ETH Wiz click™ communicates with the target board MCU through mikroBUS™ RSTn, SCSn, SCLK, MISO, MOSI and INTn lines. The board uses a 3.3V power supply only.

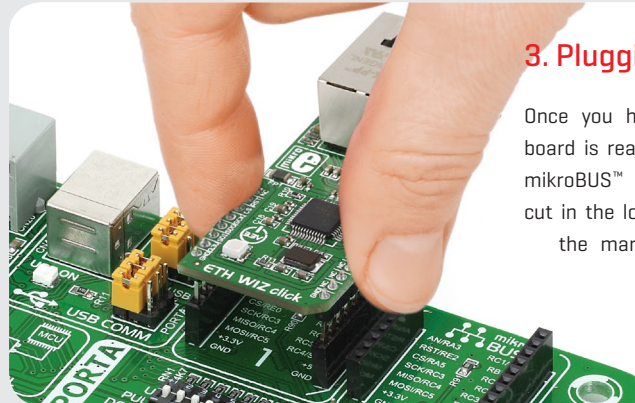

### 3. Plugging the board in

Once you have soldered the headers your board is ready to be placed into the desired mikroBUS™ socket. Make sure to align the cut in the lower-right part of the board with the markings on the silkscreen at the mikroBUS™ socket. If all the pins are aligned correctly, push the board all the way into the socket.

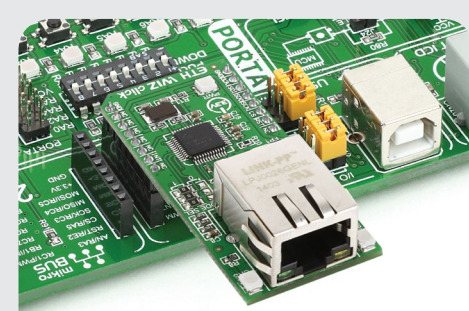

### 4. Essential features

The **W5500** module onboard ETH Wiz click™ employs a variety of solutions to reduce the target MCU's memory load and enable a stable and secure Internet connection. High speed network communications are realized through a **80 MHz SPI** interface. The module has **32KB of internal memory** for TX/RX buffers. Reduced power consumption is achieved with **Wake on LAN and power down modes**. Automatic handshaking, retransmit on collision and automatic rejection of erroneous packets are also supported. The board is ideal for Home network devices and all sorts of embedded servers.

click™  
BOARD  
[www.mikroe.com](http://www.mikroe.com)



ETH WIZ click™ manual  
ver 1.01



010000076279

## 5. Schematic

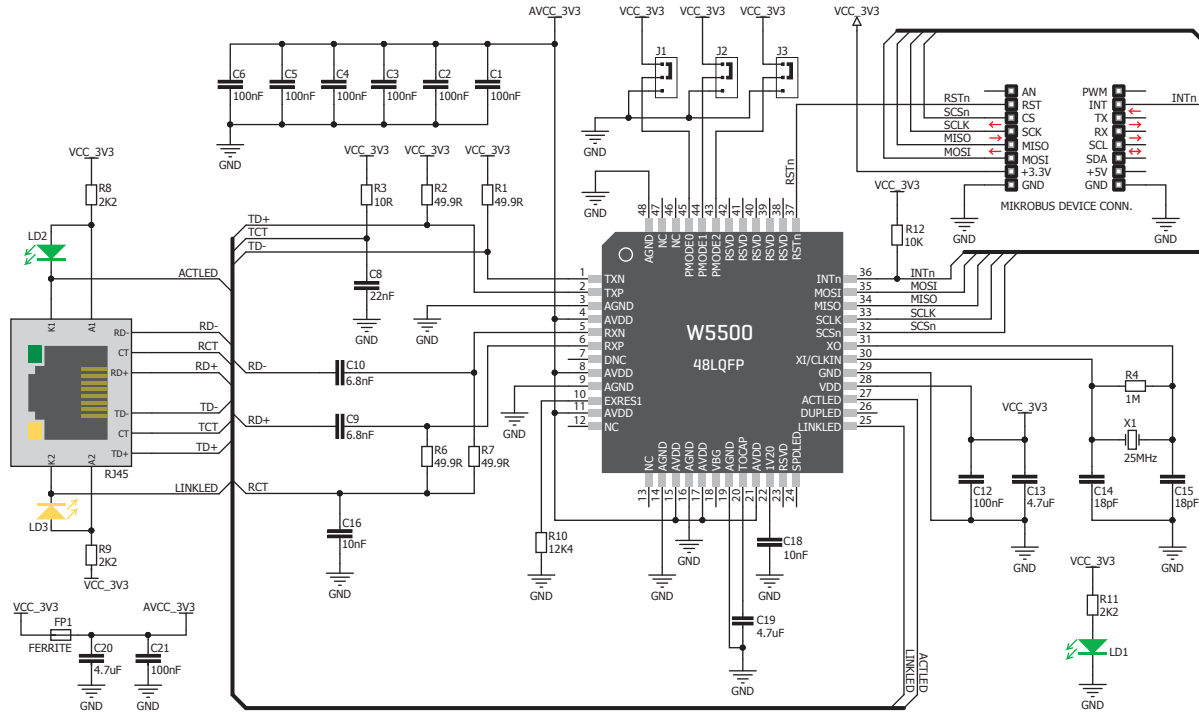

## 6. Dimensions

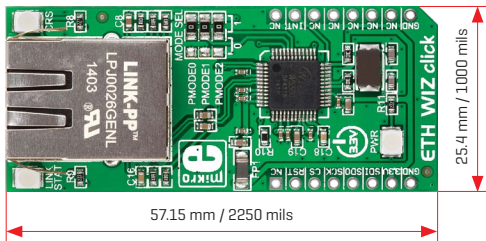

	mm	mils
LENGTH	57.15	2250
WIDTH	25.4	1000
HEIGHT*	12	472.5

\* without headers

## 7. Mode selection jumpers

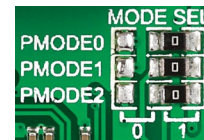

These three SMD jumpers [zero ohm resistors] are used for specifying the PHY network operation mode. For detailed configuration instructions, consult Wiznet's data sheet for the W5500 module.

## 8. Code examples

Once you have done all the necessary preparations, it's time to get your click™ board up and running. We have provided examples for mikroC™, mikroBasic™ and mikroPascal™ compilers on our **Libstock** website. Just download them and you are ready to start.



## 9. Support

MikroElektronika offers **free tech support** [[www.mikroe.com/support](http://www.mikroe.com/support)] until the end of the product's lifetime, so if something goes wrong, we're ready and willing to help!



## 10. Disclaimer

MikroElektronika assumes no responsibility or liability for any errors or inaccuracies that may appear in the present document. Specification and information contained in the present schematic are subject to change at any time without notice.

Copyright © 2015 MikroElektronika.  
All rights reserved.