

HDC1000 click™

2. Soldering the headers

Before using your click™ board, make sure to solder 1x8 male headers to both left and right side of the board. Two 1x8 male headers are included with the board in the package.

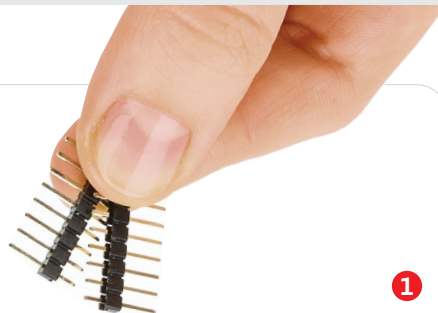

1

2

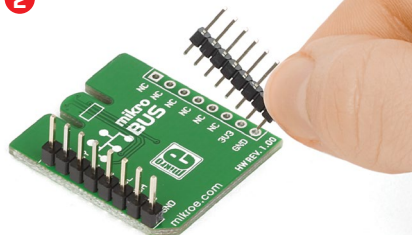

Turn the board upside down so that the bottom side is facing you upwards. Place shorter pins of the header into the appropriate soldering pads.

3

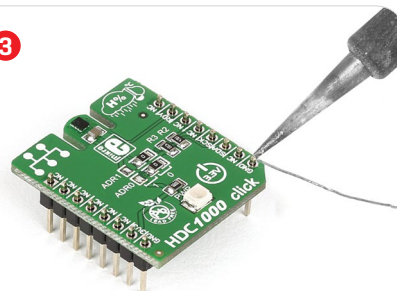

Turn the board upward again. Make sure to align the headers so that they are perpendicular to the board, then solder the pins carefully.

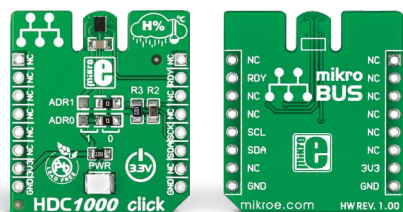

1. Introduction

HDC1000 click™ is a humidity [and temperature] measurement click™ board carrying the **HDC1000** sensor from **Texas Instruments**. Its chief features are low power consumption, precision, and resistance to dirt, dust and other contaminants. HDC1000 click™ communicates with the target board microcontroller through **mikroBUS™** I²C lines (SCL, SDA) plus the INT pin, used here for DRDY (Data Ready). The board is designed to use a 3.3V power supply only.

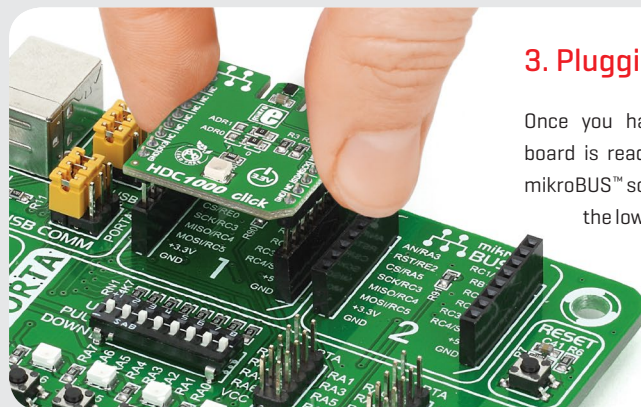

3. Plugging the board in

Once you have soldered the headers your board is ready to be placed into the desired mikroBUS™ socket. Make sure to align the cut in the lower-right part of the board with the markings on the silkscreen at the mikroBUS™ socket. If all the pins are aligned correctly, push the board all the way into the socket.

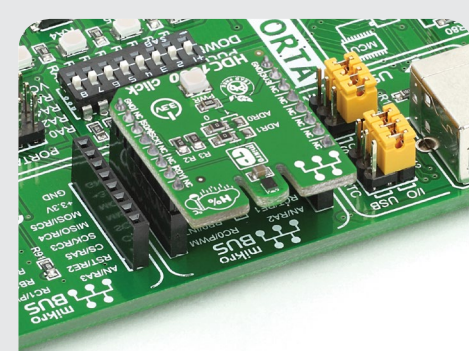

4. Essential features

The sensor aboard HDC1000 click™ operates either in sleep [waiting for I²C input] or measurement mode [returning to sleep after acquiring the measurements and setting DRDY pin to low]. The relative humidity [0-100%RH] is measured with an accuracy of $\pm 3\%$; the temperature is measured within a range from -20°C to 85°C with $\pm 0.2^{\circ}\text{C}$ accuracy. All measurements are taken with a 14-bit resolution. HDC1000 click™ also features two jumpers that allow you to select between four I²C addresses.

click™
BOARD
www.mikroe.com



HDC1000 click™ manual
ver 1.00



010000074138

5. Schematic

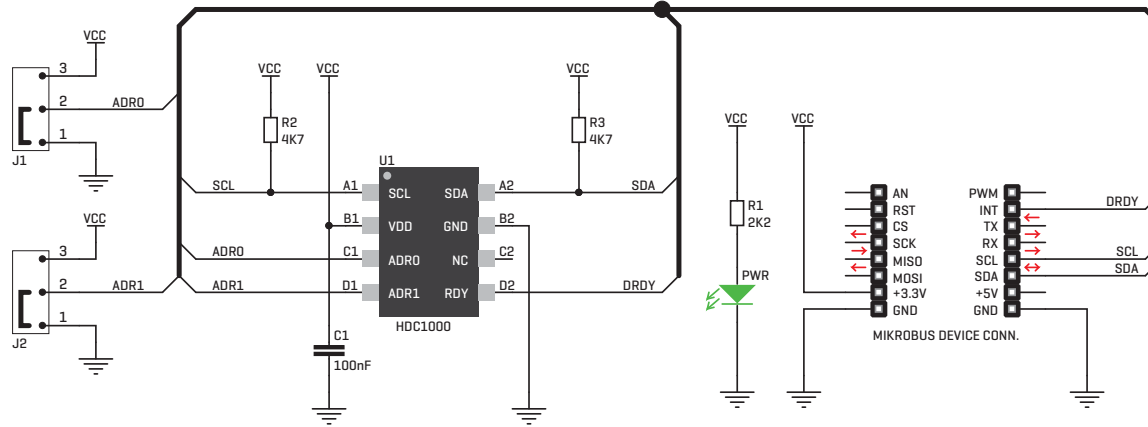

6. Dimensions

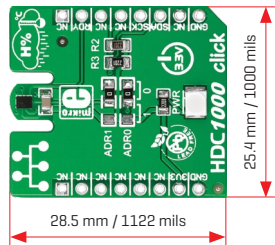

	mm	mils
LENGTH	28.5	1122
WIDTH	25.4	1000
HEIGHT*	4	157.5

* without headers

7. I²C address select

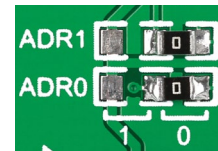

The HDC100 sensor acts as a slave on the I²C interface. Two jumpers (zero-ohm resistors)

on the click™ board let you specify the slave address byte [4 possible configurations, consult the sensor's data sheet for details].

8. Code examples

Once you have done all the necessary preparations, it's time to get your click™ board up and running. We have provided examples for mikroC™, mikroBasic™ and mikroPascal™ compilers on our **Libstock** website. Just download them and you are ready to start.



9. Support

MikroElektronika offers **free tech support** [www.mikroe.com/support] until the end of the product's lifetime, so if something goes wrong, we're ready and willing to help!



10. Disclaimer

MikroElektronika assumes no responsibility or liability for any errors or inaccuracies that may appear in the present document. Specification and information contained in the present schematic are subject to change at any time without notice.

Copyright © 2015 MikroElektronika.
All rights reserved.