

Pressure 2 click™

2. Soldering the headers

Before using your click™ board, make sure to solder 1x8 male headers to both left and right side of the board. Two 1x8 male headers are included with the board in the package.

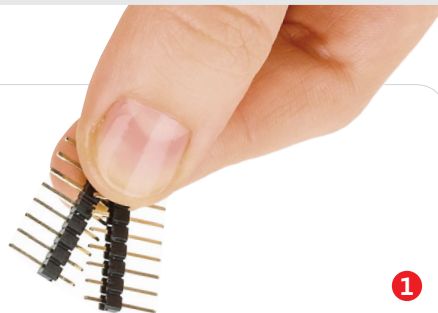

1

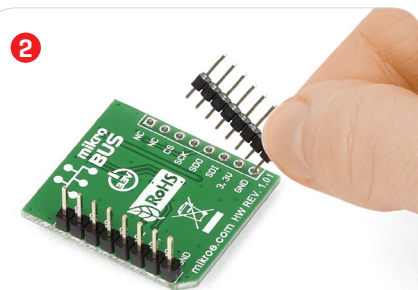

Turn the board upside down so that the bottom side is facing you upwards. Place shorter pins of the header into the appropriate soldering pads.

2

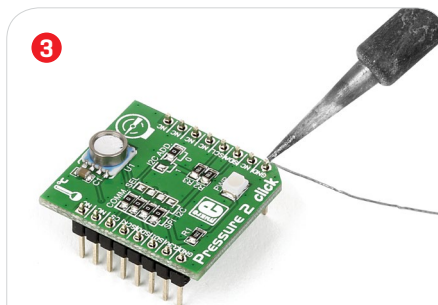

Turn the board upward again. Make sure to align the headers so that they are perpendicular to the board, then solder the pins carefully.

3

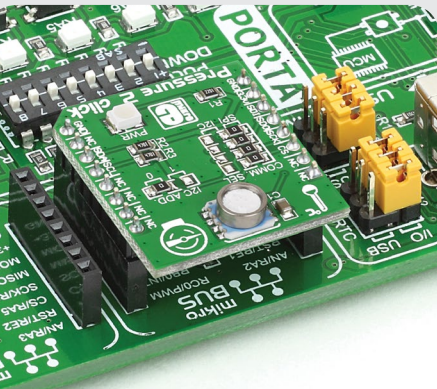

4. Essential features

The MS5803-14BA is both precise and robust. The measurement resolution is up to 0.2 mbars, but an antimagnetic stainless steel cap enclosure allows it to withstand up to 30 bars of pressure [more than twice the maximum measurement range]. Therefore, *Pressure 2 click™* is ideal for developing mobile pressure measurement systems, such as for adventure watches, diving computers and similar devices.

1. Introduction

Pressure 2 click™ carries **MS5803-14BA**, a **high resolution MEMS pressure sensor** with an **operating range from 0 to 14 bars**. The module comprises a high linear pressure sensor and an ultra low power 24 bit ADC. It is optimized for depth measurement systems with a water depth resolution of 1cm and below. *Pressure 2 click™* communicates with the target board MCU either through **mikroBUS™ SPI** [CS, SCK, SDO, SDI] or **I²C** lines [SCL, SDA]. The board is designed to use a 3.3V power supply only.

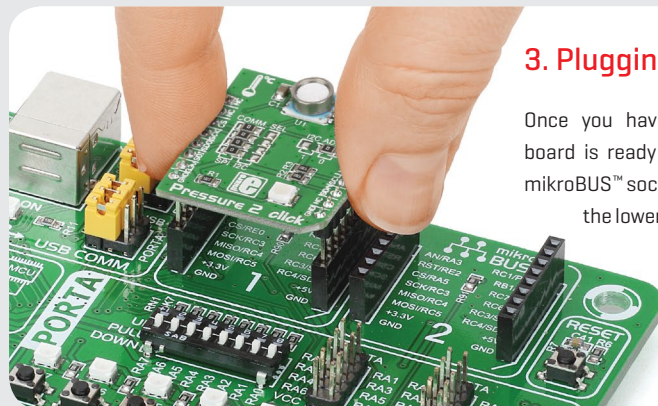

3. Plugging the board in

Once you have soldered the headers your board is ready to be placed into the desired mikroBUS™ socket. Make sure to align the cut in the lower-right part of the board with the markings on the silkscreen at the mikroBUS™ socket. If all the pins are aligned correctly, push the board all the way into the socket.

click™
BOARD
www.mikroe.com



Pressure 2 click™ manual
ver 1.01



010000077436

5. Schematic

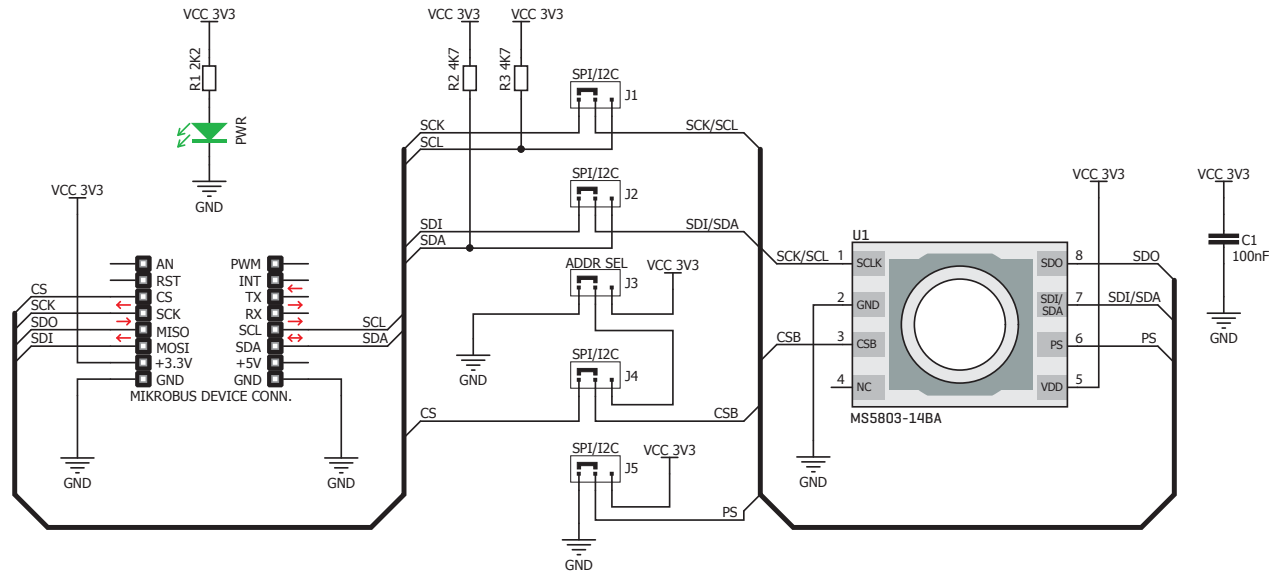

6. Dimensions

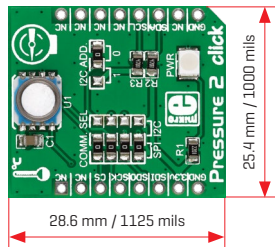

| | mm | mils |
|---------|------|------|
| LENGTH | 28.6 | 1125 |
| WIDTH | 25.4 | 1000 |
| HEIGHT* | 4.5 | 177 |

* without headers

7. SMD jumper

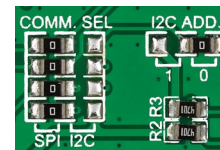

Pressure 2 click™ carries two sets of jumpers [zero ohm resistors]. The group of four COMM. SEL jumpers is for choosing between SPI or I²C interface. I²C ADD is for specifying the I²C address.

8. Code examples

Once you have done all the necessary preparations, it's time to get your click™ board up and running. We have provided examples for mikroC™, mikroBasic™ and mikroPascal™ compilers on our **Libstock** website. Just download them and you are ready to start.



9. Support

MikroElektronika offers **free tech support** [www.mikroe.com/support] until the end of the product's lifetime, so if something goes wrong, we're ready and willing to help!



10. Disclaimer

MikroElektronika assumes no responsibility or liability for any errors or inaccuracies that may appear in the present document. Specification and information contained in the present schematic are subject to change at any time without notice.

Copyright © 2015 MikroElektronika.
All rights reserved.