

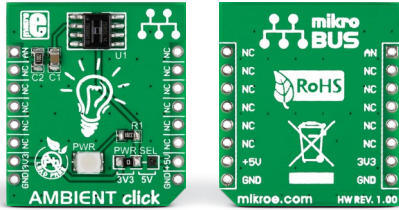

## AMBIENT click



### 1. Introduction

*Ambient click* is an ambient light sensor carrying the Melexis **MLX75305 IC**. This chip consists of a photodiode, a transimpedance amplifier, and an output transistor. It converts the ambient light intensity into a voltage, using the **mikroBUS™** AN pin for communicating with the target board microcontroller. The board is designed to use either a 3.3V or a 5V power supply.

### 2. Soldering the headers

Before using your click board™, make sure to solder 1x8 male headers to both left and right side of the board. Two 1x8 male headers are included with the board in the package.

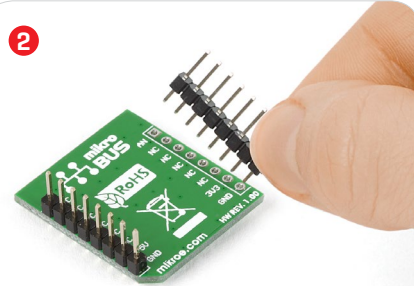
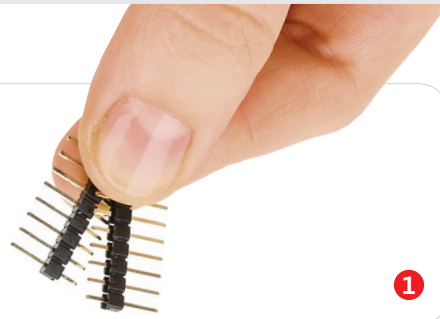

Turn the board upside down so that the bottom side is facing you upwards. Place shorter pins of the header into the appropriate soldering pads.

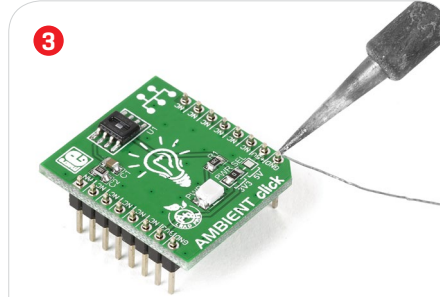

Turn the board upward again. Make sure to align the headers so that they are perpendicular to the board, then solder the pins carefully.

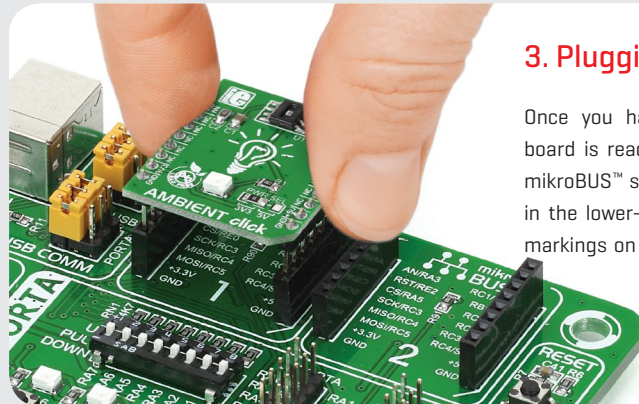

### 3. Plugging the board in

Once you have soldered the headers your board is ready to be placed into the desired mikroBUS™ socket. Make sure to align the cut in the lower-right part of the board with the markings on the silkscreen at the mikroBUS™ socket. If all the pins are aligned correctly, push the board all the way into the socket.

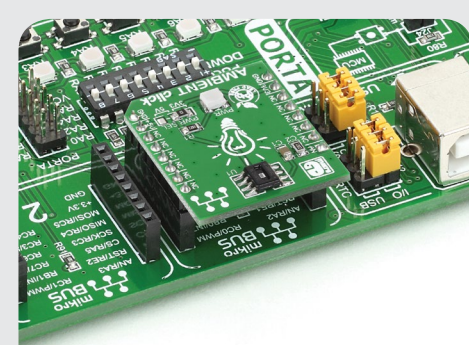

### 4. Essential features

*Ambient click* has a variety of applications. For example, to automatically dim or brighten the backlight intensity on a portable LCD display that's meant to be used in many different lighting conditions; this is done both to conserve battery and to increase comfort to the end user. Likewise, it can be used in smart homes to automate lighting and save energy. Indirectly, the presence or absence of light can be used to deduce other relevant information. For example, paper feed detection or paper size and orientation detection in printers and copiers.

**click**  
BOARD™  
[www.mikroe.com](http://www.mikroe.com)



AMBIENT click manual  
ver 1.00



010000079119

## 5. Schematic

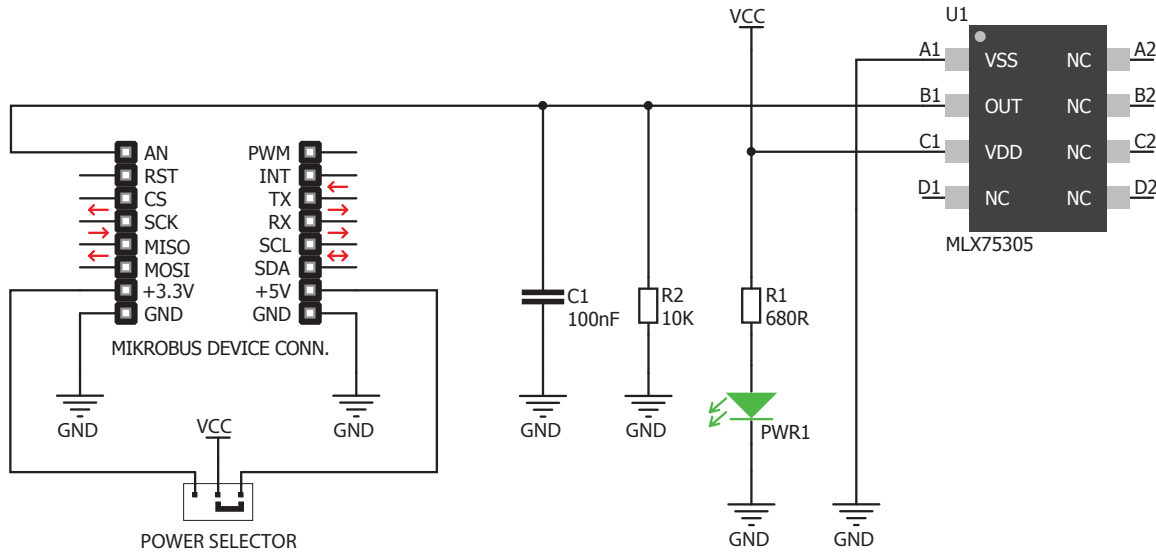

## 6. Dimensions

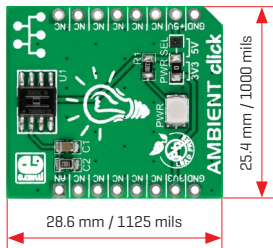

	mm	mils
LENGTH	28.6	1125
WIDTH	25.4	1000
HEIGHT*	3.6	142

\* without headers

## 7. SMD jumper

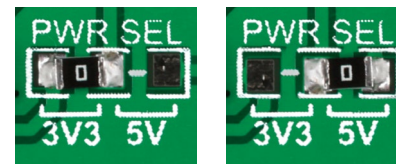

Ambient click has a PWR SEL jumper [zero ohm resistor] that lets you switch between 3.3V and 5V power supplies.

## 8. Code examples

Once you have done all the necessary preparations, it's time to get your click board™ up and running. We have provided examples for mikroC™, mikroBasic™ and mikroPascal™ compilers on our **Libstock** website. Just download them and you are ready to start.



## 9. Support

MikroElektronika offers **free tech support** [[www.mikroe.com/support](http://www.mikroe.com/support)] until the end of the product's lifetime, so if something goes wrong, we're ready and willing to help!



## 10. Disclaimer

MikroElektronika assumes no responsibility or liability for any errors or inaccuracies that may appear in the present document. Specification and information contained in the present schematic are subject to change at any time without notice.

Copyright © 2015 MikroElektronika.  
All rights reserved.