

RTC4 click

2. Soldering the headers

Before using your click board™, make sure to solder 1x8 male headers to both left and right side of the board. Two 1x8 male headers are included with the board in the package.

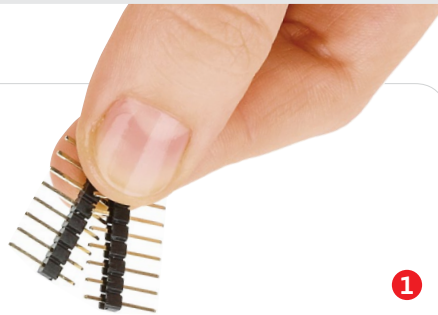

1

2

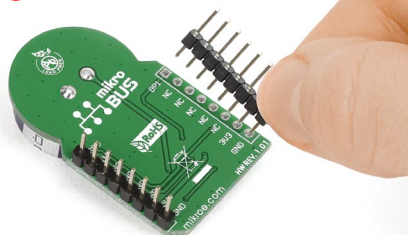

Turn the board upside down so that the bottom side is facing you upwards. Place shorter pins of the header into the appropriate soldering pads.

3

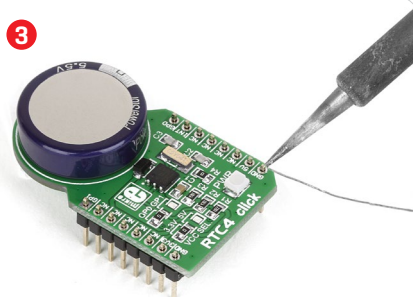

Turn the board upward again. Make sure to align the headers so that they are perpendicular to the board, then solder the pins carefully.

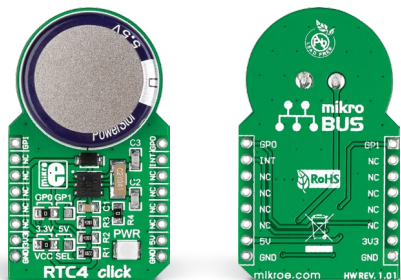

1. Introduction

RTC4 click carries **DS2417**, a real time clock/calendar with a 1-Wire MicroLAN interface and a programmable interrupt for system output. The clock frequency is derived from an onboard 32.768KHz oscillator. The clock has an accuracy of +/-2 minutes per month at a 25 degrees Celsius temperature. Depending on the position of the onboard jumper, RTC4 click communicates with the target board MCU either through **mikroBUS™** AN or PWM pin [here, GPIO1, GPIO0], plus the INT pin. The board is designed to use either a 3.3V or 5V power supply.

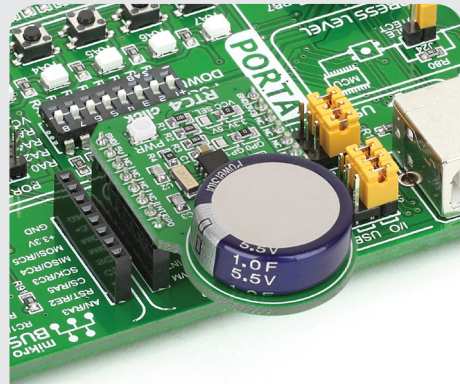

4. Essential features

RTC4 click has an integrated backup energy source that maintains a charge with an onboard coin cell supercapacitor. Being a 1-Wire click board™, RTC4 click can operate in a microLAN network [a network of 1-Wire devices that are all associated with a master device]. To identify it in a network, the DS2417 IC has a factory lasered and tested 64-bit registration number. RTC4 click is ideal for applications that require realtime clocks, calendars and programmed alarms.

3. Plugging the board in

Once you have soldered the headers your board is ready to be placed into the desired mikroBUS™ socket. Make sure to align the cut in the lower-right part of the board with the markings on the silkscreen at the mikroBUS™ socket. If all the pins are aligned correctly, push the board all the way into the socket.

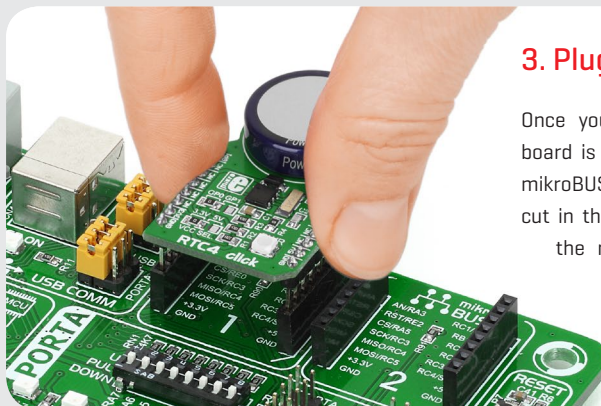

click
BOARD™
www.mikroe.com



RTC4 click manual
ver 1.01



5. Schematic

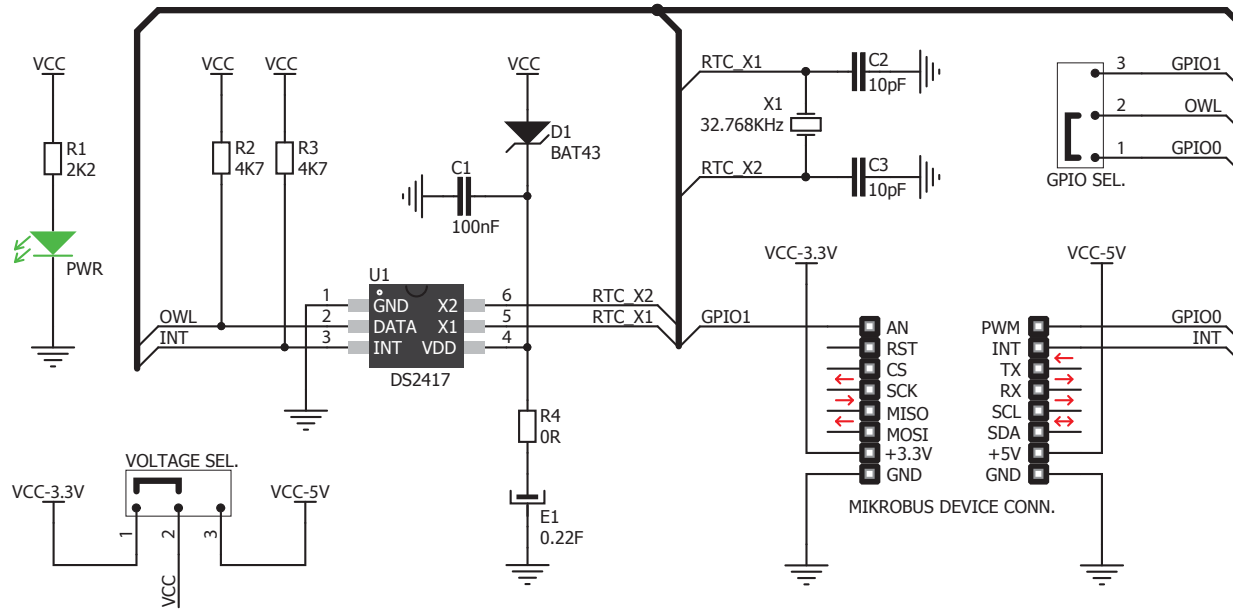

6. Dimensions

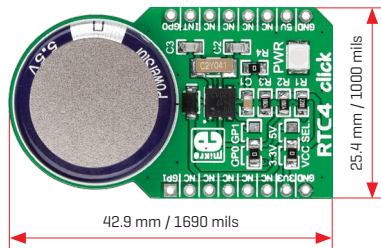

	mm	mils
LENGTH	42.9	1690
WIDTH	25.4	1000
HEIGHT*	9.3	366

* without headers

7. SMD Jumper

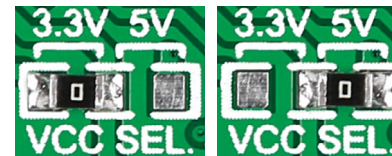

RTC4 click has a VCC SEL jumper [zero ohm resistor] that lets you switch the board from **3.3V to 5V power supply**.

8. Code examples

Once you have done all the necessary preparations, it's time to get your click board™ up and running. We have provided examples for mikroC™, mikroBasic™ and mikroPascal™ compilers on our **Libstock** website. Just download them and you are ready to start.



9. Support

MikroElektronika offers **free tech support** [www.mikroe.com/support] until the end of the product's lifetime, so if something goes wrong, we're ready and willing to help!



10. Disclaimer

MikroElektronika assumes no responsibility or liability for any errors or inaccuracies that may appear in the present document. Specification and information contained in the present schematic are subject to change at any time without notice.

Copyright © 2015 MikroElektronika.
All rights reserved.