

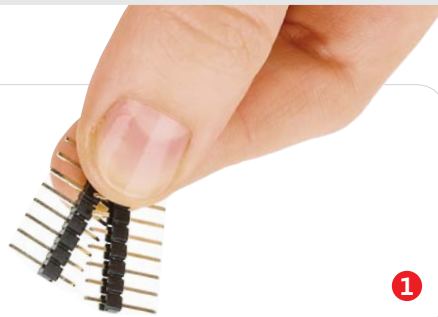

I2C 1-WIRE click™

2. Soldering the headers

Before using your click™ board, make sure to solder 1x8 male headers to both left and right side of the board. Two 1x8 male headers are included with the board in the package.



1

2



Turn the board upside down so that the bottom side is facing you upwards. Place shorter pins of the header into the appropriate soldering pads.

3

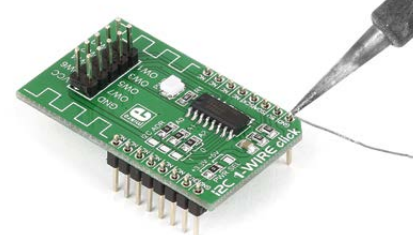

Turn the board upward again. Make sure to align the headers so that they are perpendicular to the board, then solder the pins carefully.

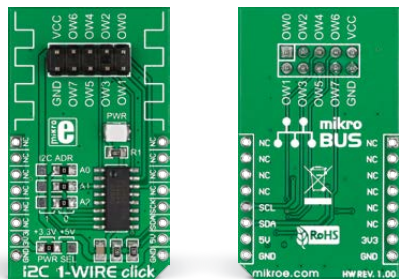

1. Introduction

I2C 1-Wire click™ carries **DS2482**, a “bridge device” that performs bidirectional conversions between I²C masters and 1-Wire slave devices. The I²C interface [mikroBUS™ SCL and SDA pins] supports both standard I²C [100kHz max] and fast [400kHz] communication speeds. In addition to the mikroBUS™ socket, *I2C 1-Wire click™* has an 8-channel pinout [each pin an independently operated 1-Wire I/O]. The board is designed to use either a 3.3V or 5V power supply.

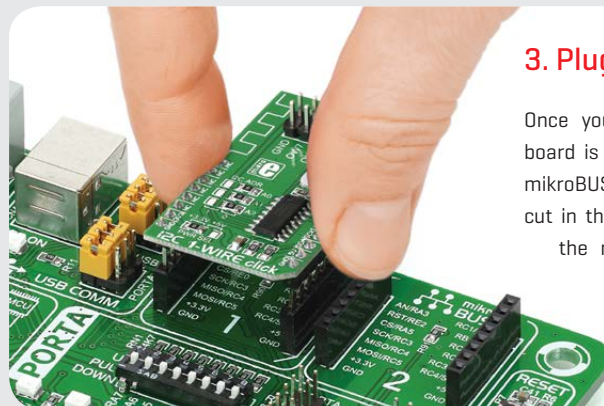

3. Plugging the board in

Once you have soldered the headers your board is ready to be placed into the desired mikroBUS™ socket. Make sure to align the cut in the lower-right part of the board with the markings on the silkscreen at the mikroBUS™ socket. If all the pins are aligned correctly, push the board all the way into the socket.



4. Essential features

I2C 1-Wire click™ enables the host MCU to generate properly timed 1-Wire waveforms to its slave devices. These can be EEPROM chips, temperature sensors and similar devices that have momentary high source current modes. The board features three jumpers for assigning I²C addresses.

click™
BOARD
www.mikroe.com



I2C 1-WIRE click™ manual
ver 1.00



010000078136

5. Schematic

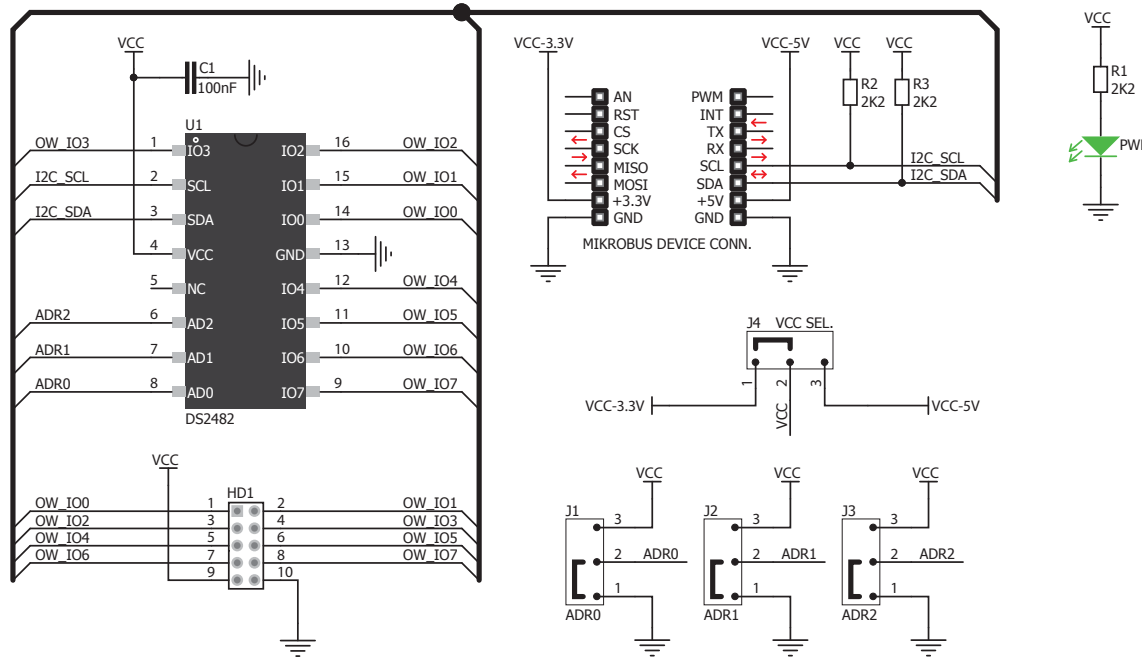

6. Dimensions

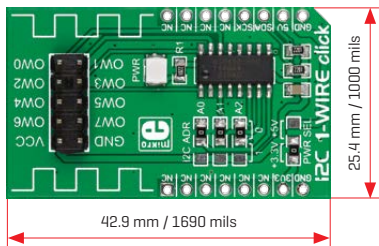

	mm	mils
LENGTH	42.9	1690
WIDTH	25.4	1000
HEIGHT*	3.3	130

* without headers

7. SMD Jumper

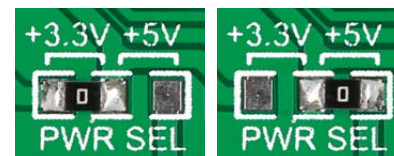

The board features a VCC SEL. Jumper [zero ohm resistor] that allows you to choose between a **3.3V or 5V power supply**. By default it's soldered in the 3.3V position.

8. Code examples

Once you have done all the necessary preparations, it's time to get your click™ board up and running. We have provided examples for mikroC™, mikroBasic™ and mikroPascal™ compilers on our **Libstock** website. Just download them and you are ready to start.



9. Support

MikroElektronika offers **free tech support** [www.mikroe.com/support] until the end of the product's lifetime, so if something goes wrong, we're ready and willing to help!



10. Disclaimer

MikroElektronika assumes no responsibility or liability for any errors or inaccuracies that may appear in the present document. Specification and information contained in the present schematic are subject to change at any time without notice.

Copyright © 2015 MikroElektronika.
All rights reserved.