

RELAY 2 click

2. Soldering the headers

Before using your click board™, make sure to solder 1x8 male headers to both left and right side of the board. Two 1x8 male headers are included with the board in the package.

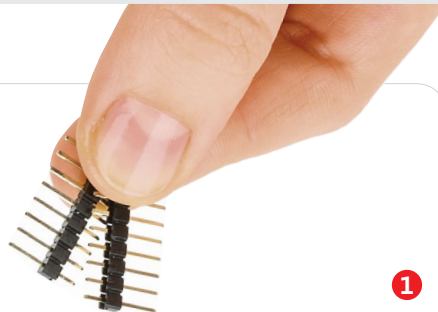

2

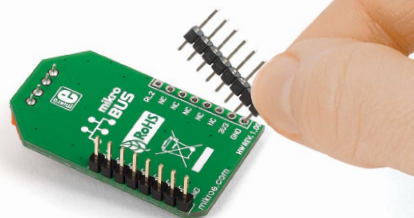

Turn the board upside down so that the bottom side is facing you upwards. Place shorter pins of the header into the appropriate soldering pads.

3

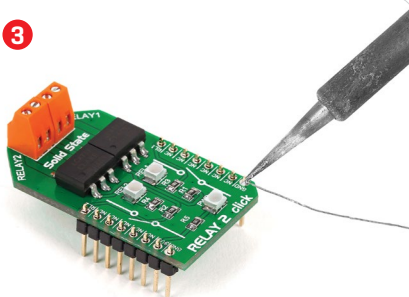

Turn the board upward again. Make sure to align the headers so that they are perpendicular to the board, then solder the pins carefully.

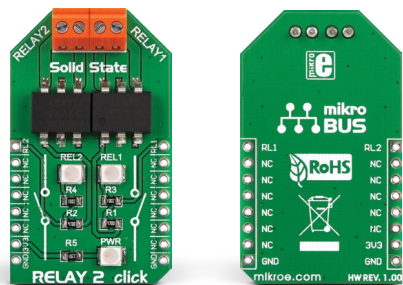

1. Introduction

Relay 2 click carries two **LCA717** single-pole, OptoMOS® solid state relays and two screw terminals for connecting the wiring. These relays have a load current of 2A, low maximum on-resistance of just 0.15 Ohms, and a blocking Voltage of 30V. They are controlled by the microcontroller through RL1 and RL2 pins, which are in place of default mikroBUS™ AN and PWM pins. The board is designed to use a 3.3V power supply only.

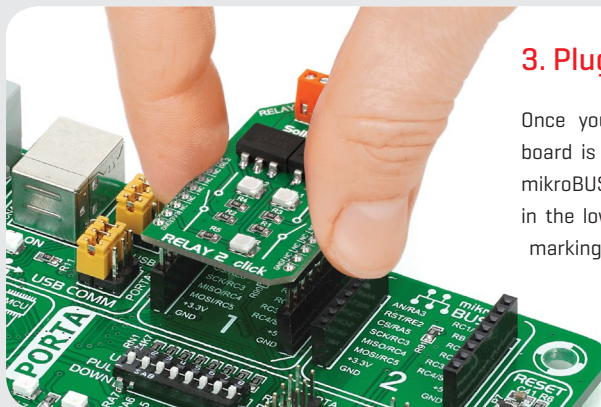

3. Plugging the board in

Once you have soldered the headers your board is ready to be placed into the desired mikroBUS™ socket. Make sure to align the cut in the lower-right part of the board with the markings on the silkscreen at the mikroBUS™ socket. If all the pins are aligned correctly, push the board all the way into the socket.

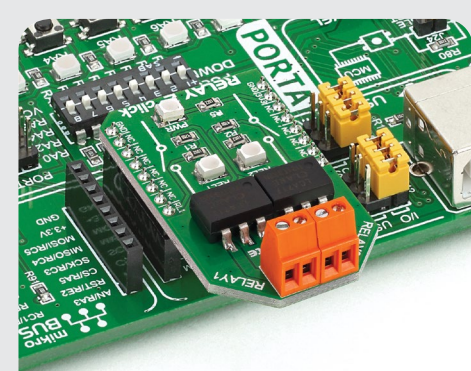

4. Essential features

Relay is an electrical switch used to terminate or establish circuit using a low power signal from a microcontroller. Relay provides complete electrical isolation between the microcontroller and controlled circuits. The LCA717 have optically coupled outputs that use the patented *OptoMOS technology*. Solid state relays enable fast, silent and bounce-free switching. On this click board™, each relay has a corresponding onboard signal LED to indicate whether it's on or off.

click
BOARD™
www.mikroe.com



RELAY 2 click manual
ver 1.00



010000080283

5. Schematic

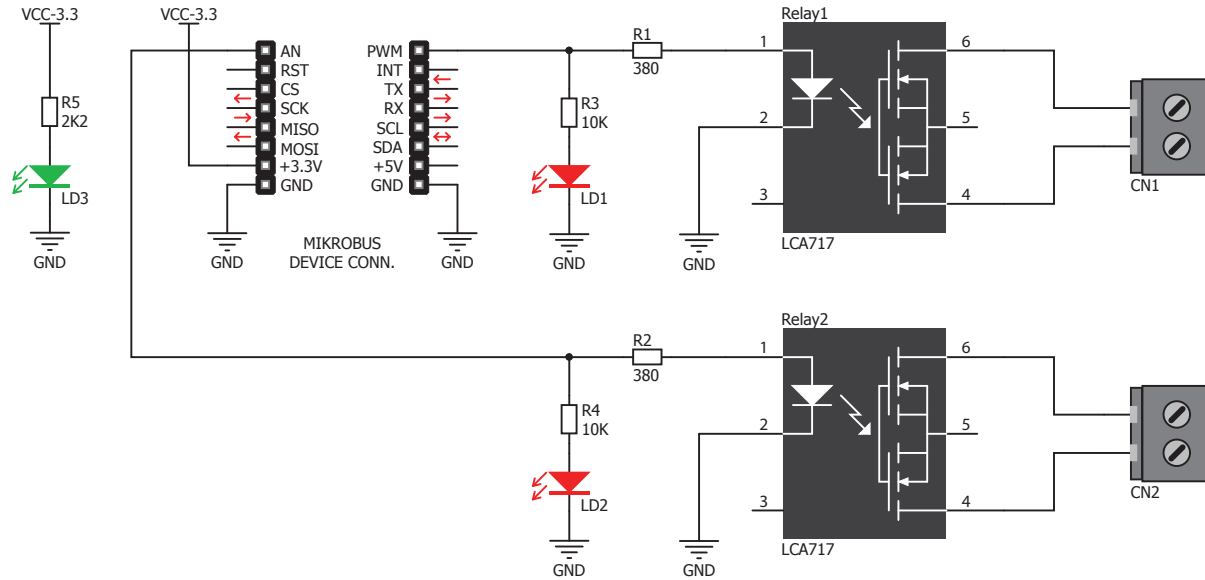

6. Dimensions

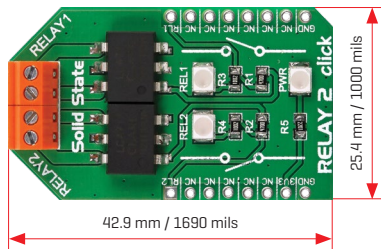

	mm	mils
LENGTH	42.9	1690
WIDTH	25.4	1000
HEIGHT*	12.2	480

* without headers

7. Alternative solution

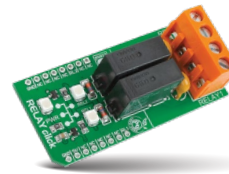

If you require a relay which can handle higher currents and voltages, see the original *Relay click*: www.mikroe.com/click/relay

8. Code examples

Once you have done all the necessary preparations, it's time to get your click board™ up and running. We have provided examples for mikroC™, mikroBasic™ and mikroPascal™ compilers on our **Libstock** website. Just download them and you are ready to start.



9. Support

MikroElektronika offers **free tech support** [www.mikroe.com/support] until the end of the product's lifetime, so if something goes wrong, we're ready and willing to help!



10. Disclaimer

MikroElektronika assumes no responsibility or liability for any errors or inaccuracies that may appear in the present document. Specification and information contained in the present schematic are subject to change at any time without notice.

Copyright © 2015 MikroElektronika.
All rights reserved.