

TouchKey click

2. Soldering the headers

Before using your click board™, make sure to solder 1x8 male headers to both left and right side of the board. Two 1x8 male headers are included with the board in the package.

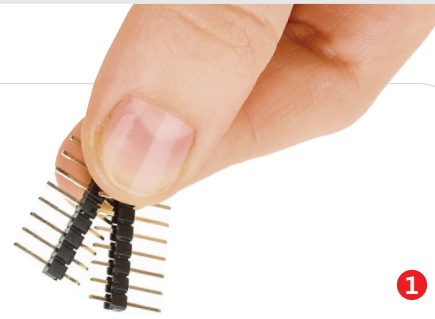

1

2

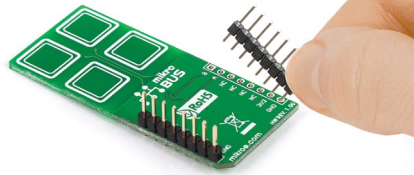

Turn the board upside down so that the bottom side is facing you upwards. Place shorter pins of the header into the appropriate soldering pads.

3

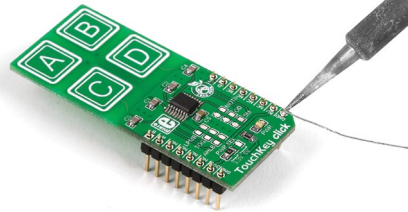

Turn the board upward again. Make sure to align the headers so that they are perpendicular to the board, then solder the pins carefully.

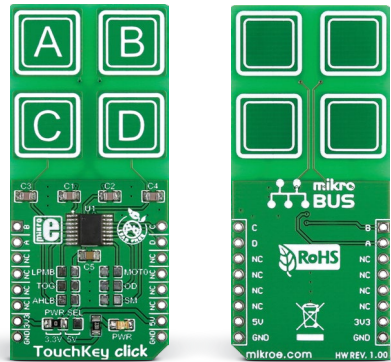

1. Introduction

TouchKey click has four capacitive pads powered by **TTP224**, a touchpad detector IC. The board outputs an interrupt signal for each pad: OUTA, OUTB, OUTC and OUTD (in place of default mikroBUS™ RST, AN, PWM and INT pins, respectively, respectively). *TouchKey click* is designed to work either with a 3.3V or 5V power supply.

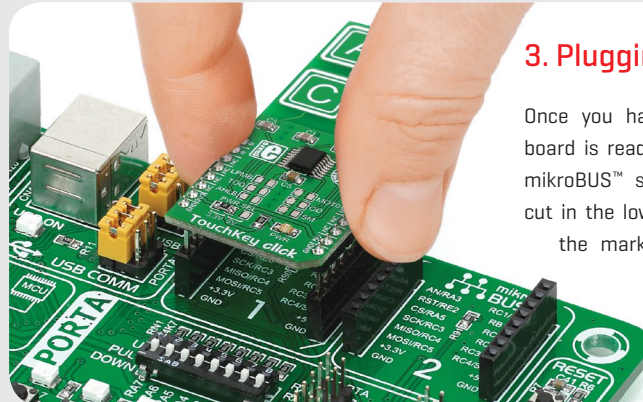

3. Plugging the board in

Once you have soldered the headers your board is ready to be placed into the desired mikroBUS™ socket. Make sure to align the cut in the lower-right part of the board with the markings on the silkscreen at the mikroBUS™ socket. If all the pins are aligned correctly, push the board all the way into the socket.

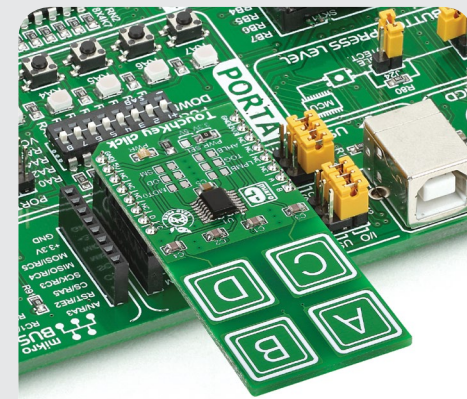

4. Essential features

TouchKey click offers a replacement for standard mechanical switches and buttons. It can be used in a wide variety of applications and under diverse conditions, but perhaps the most interesting feature is that the keys can be toggled even through a layer of glass, paper, or similar non-isolating materials. The response time is just 100mS at fast mode and 200mS at low power mode.

click
BOARD™
www.mikroe.com



TouchKey click manual
ver 1.00



010000080276

5. Schematic

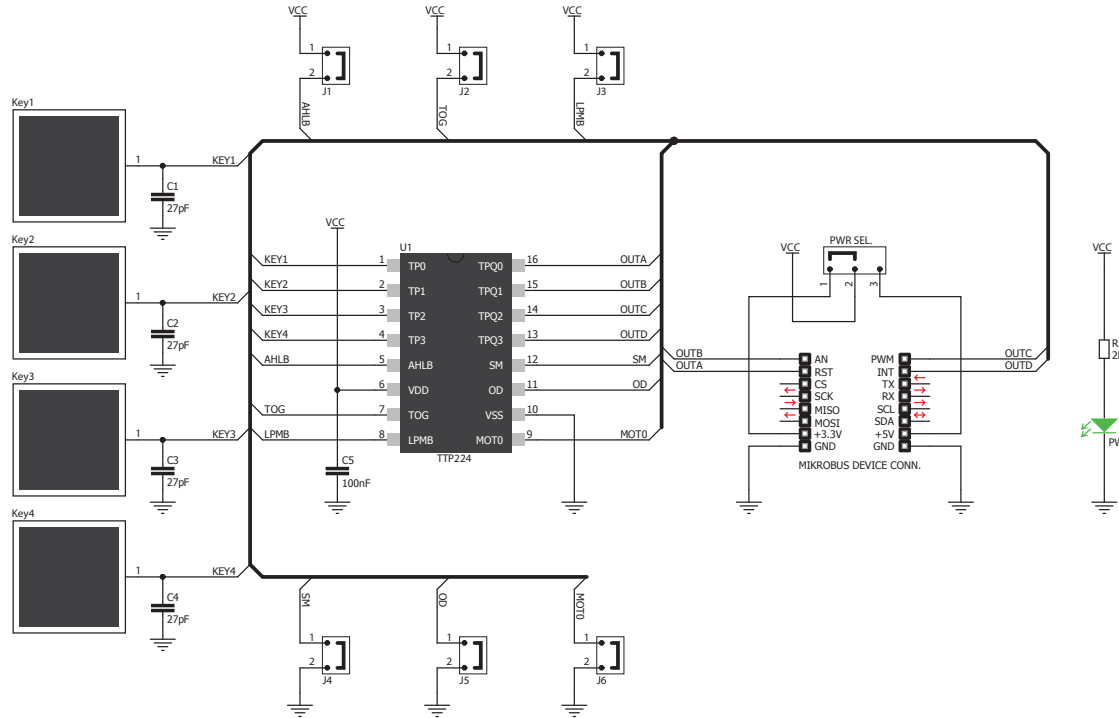

6. Dimensions

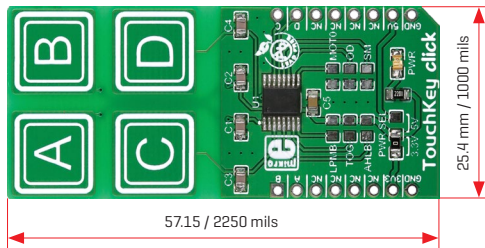

	mm	mils
LENGTH	57.15	2250
WIDTH	25.4	1000
HEIGHT*	3.2	126

* without headers

7. SMD jumpers

	DEFAULT	SECONDARY
LPMB	Fast	Low power
TOG	Direct	Toggle
AHLB	High output	Low output
MOTO	Infinite on time	16 Sec. Max on time
OD	CMOS active	Open drain
SM	Multi-key	Single-key

TouchKey click has three jumpers for putting the TTP224 IC into different operating modes.

8. Code examples

Once you have done all the necessary preparations, it's time to get your click board™ up and running. We have provided examples for mikroC™, mikroBasic™ and mikroPascal™ compilers on our **Libstock** website. Just download them and you are ready to start.



9. Support

MikroElektronika offers **free tech support** [www.mikroe.com/support] until the end of the product's lifetime, so if something goes wrong, we're ready and willing to help!



10. Disclaimer

MikroElektronika assumes no responsibility or liability for any errors or inaccuracies that may appear in the present document. Specification and information contained in the present schematic are subject to change at any time without notice.

Copyright © 2015 MikroElektronika. All rights reserved.