

6LoWPAN

clicker

a new idea just a click away

A compact starter kit with your favorite microcontroller and a mikroBUS™ socket.



TO OUR VALUED CUSTOMERS

I want to express my thanks to you for being interested in our products and for having confidence in MikroElektronika.

The primary aim of our company is to design and produce high quality electronic products and to constantly improve the performance thereof in order to better suit your needs.

A handwritten signature in black ink, appearing to read 'Nebojsa Matic', with a stylized, cursive script.

Nebojsa Matic
General Manager

Table of Contents

1. Key features	4	step 2 – Browsing for .HEX file	12
2. What is 6LoWPAN clicker?	5	step 3 – Selecting .HEX file	12
2.1. 6LoWPAN clicker schematic	6	step 4 – Uploading .HEX file	13
3. EEPROM memory	7	step 5 – Finish upload	14
4. Power supply	8	Programming with mikroProg™ Programmer	15
5. PIC32MX470 microcontroller	9	7. mikroProg Suite™ for PIC® Software	16
6. Programming the microcontroller	10	7.1. Software Installation Wizard	17
Programming with mikroBootloader	11	8. click boards™ are plug and play!	18
step 1 – Connecting 6LoWPAN clicker	11	9. Dimensions	20

1. Key features

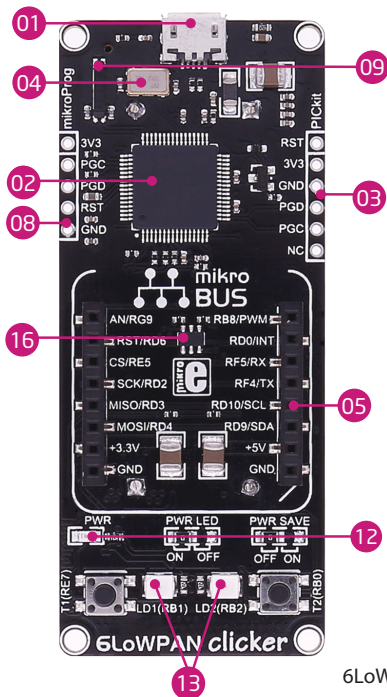

6LoWPAN clicker



- 01 Micro USB connector
- 02 PIC32MX470 MCU
- 03 PICkit™ connector
- 04 8 MHz crystal oscillator
- 05 mikroBUS™ socket
- 06 5V voltage regulator
- 07 3.3V voltage regulator
- 08 mikroProg connector
- 09 32.768 KHz crystal oscillator
- 10 Battery slots
- 11 ON/OFF switch
- 12 Power indication LED
- 13 Additional LEDs
- 14 CA-8210
- 15 16 MHz crystal oscillator
- 16 EEPROM memory

2. What is 6LoWPAN clicker?

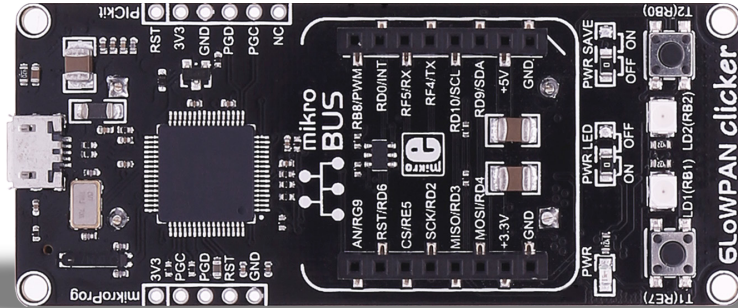

6LoWPAN clicker

6LoWPAN clicker is an amazingly compact starter development kit which brings innovative mikroBUS™ host socket to your favorite microcontroller. It features the PIC32MX470 32-bit microcontroller, CA-8210 2.4GHz ISM band transceiver, two indication LEDs, two general purpose buttons, ON/OFF switch, micro USB connector and a single mikroBUS™ host socket. mikroProg connector and pads for interfacing with external electronics are provided as well. mikroBUS™ host connector consists of two 1x8 female headers with SPI, I2C, UART, RST, PWM, Analog and Interrupt lines as well as 3.3V, 5V and GND power lines. The 6LoWPAN clicker board can be powered over two standard AAA batteries, or USB cable.

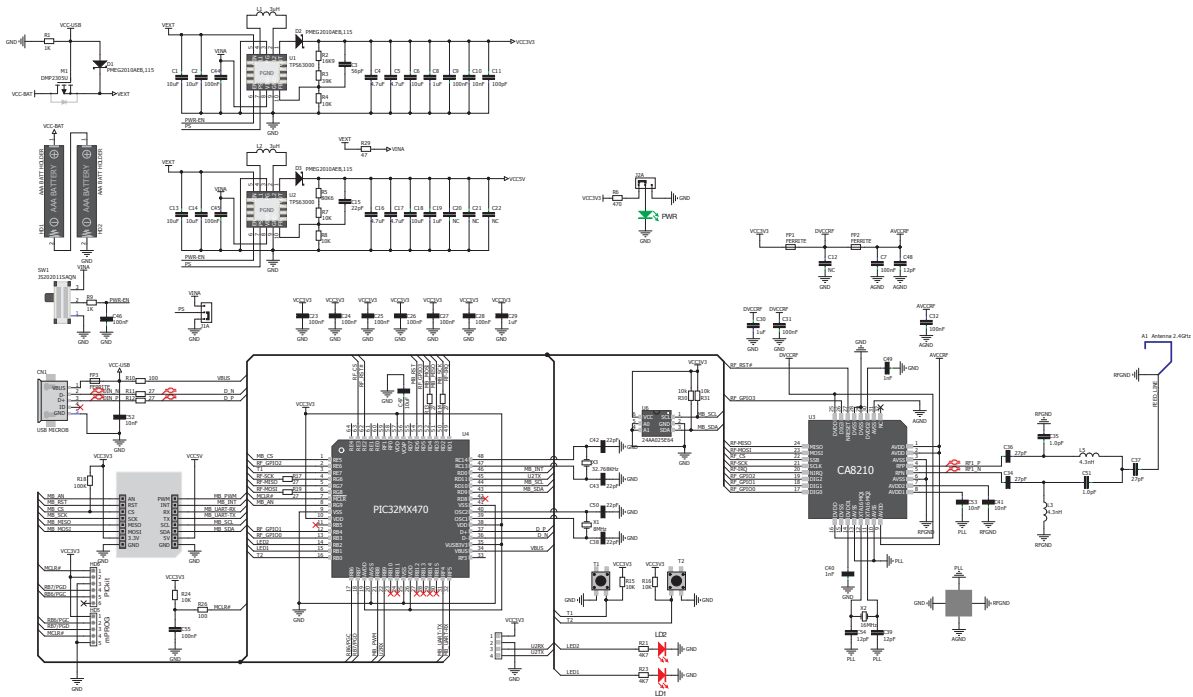

6LoWPAN clicker schematic

3. EEPROM memory

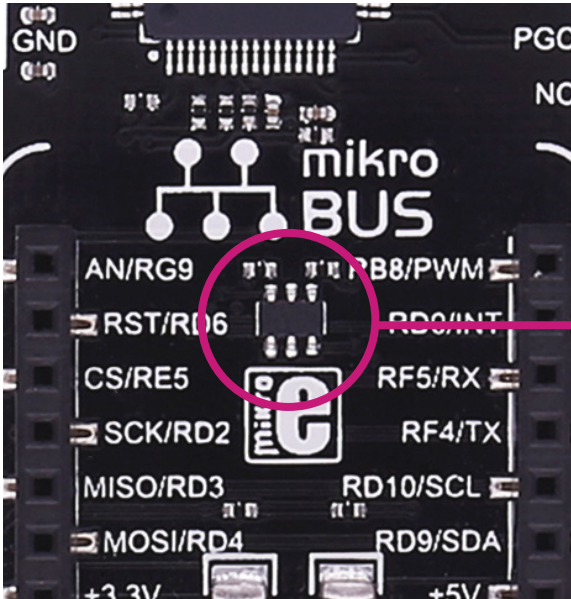

The 24AA025E64 is a 2 Kbit Electrically Erasable PROM. The device is organized as two blocks of 128 x 8-bit memory with a 2-wire serial interface.

4. Power supply

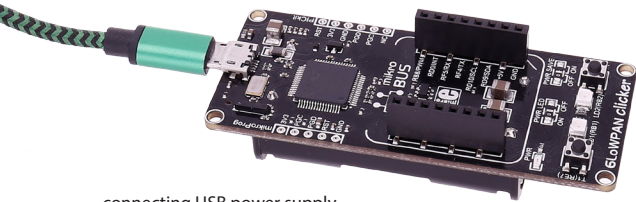

connecting USB power supply
through CN1 connector

When the board is powered up the power indication LED will be automatically turned on. The USB connection can provide up to 500mA of current which is more than enough for the operation of all on-board and additional modules.



powered with AAA
batteries

6LoWPAN clicker can be powered with two standard AAA batteries. The TPS63000 Buck-Boost converter onboard the clicker regulates the power supply from the batteries.

5. PIC32MX470 microcontroller

The 6LoWPAN clicker development tool comes with the PIC32MX470 microcontroller. This 32-bit MIPS M4K Core high performance microcontroller is rich with on-chip peripherals and features 512KB of Flash and 128KB RAM. It has integrated full speed USB 2.0 support.

Key microcontroller features

- MIPS32® M4K™ Core @ 120 MHz/150 DMIPS
- 512KB of program memory
- 128KB or RAM
- USB device/host/OTG
- 10-bit, 1 Msps, 28-channel Analog-to-Digital Converter (ADC)
- Max Speed MHz: 120
- Temperature range: -40°C to 105°C

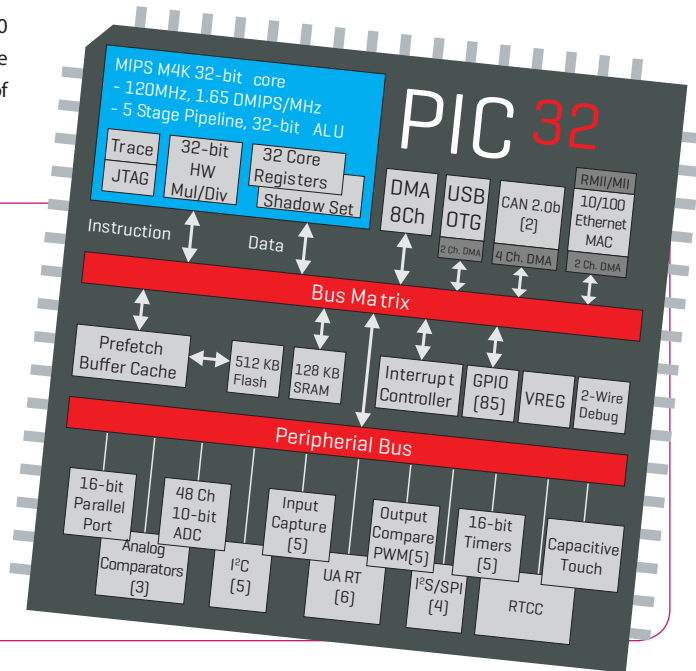

6. Programming the microcontroller

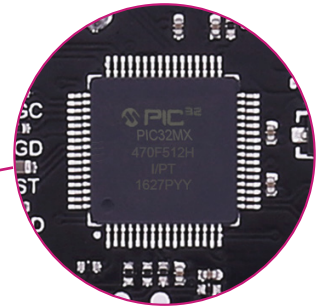
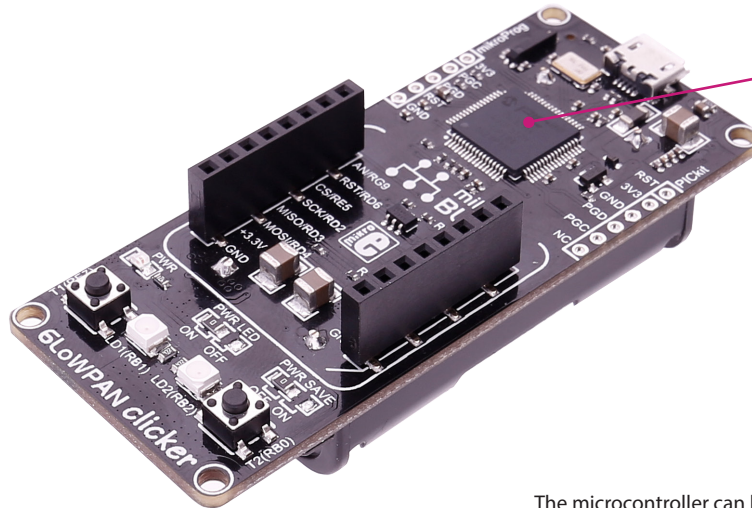

PIC32MX470
microcontroller

The microcontroller can be programmed in two ways:

- 01 Using USB HID mikroBootloader,
- 02 Using external mikroProg™ for PIC®, dsPIC®, PIC32® programmer.

Programming with mikroBootloader

You can program the microcontroller with bootloader which is preprogrammed by default. To transfer .hex file from a PC to MCU you need bootloader software (mikroBootloader USB HID) which can be downloaded from:

[download.mikroe.com/examples/starter-boards/clicker/6lowpan/clicker-6lowpan-bootloader.zip](https://www.mikroe.com/examples/starter-boards/clicker/6lowpan/clicker-6lowpan-bootloader.zip)

After the mikroBootloader software is downloaded, unzip it to desired location and start it.

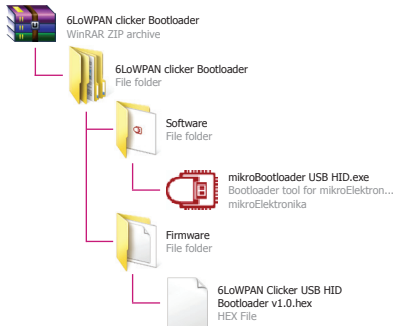

step 1 – Connecting 6LoWPAN clicker



USB HID mikroBootloader window

- 01 To start, connect the USB cable, or if already connected press the Reset button on your 6LoWPAN clicker. Click the Connect button within 5s to enter the bootloader mode, otherwise existing microcontroller program will execute.

step 2 – Browsing for .HEX file



Browse for HEX

- 01 Click the Browse for HEX button and from a pop-up window choose the .HEX file which will be uploaded to MCU memory.

step 3 – Selecting .HEX file

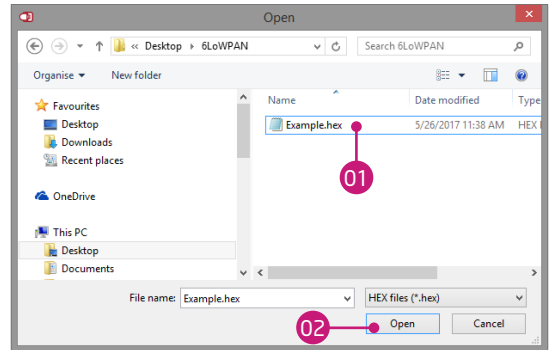

Selecting HEX

- 01 Select .HEX file using open dialog window.
- 02 Click the Open button.

step 4 – Uploading .HEX file



Begin uploading

- 01 To start .HEX file bootloading click the Begin uploading button.

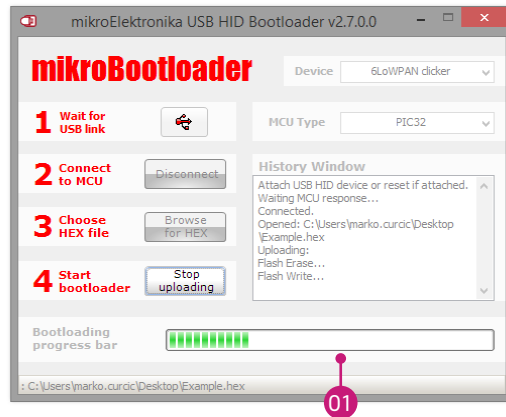

Progress bar

- 01 Progress bar enables you to monitor .HEX file uploading.

step 5 – Finish upload

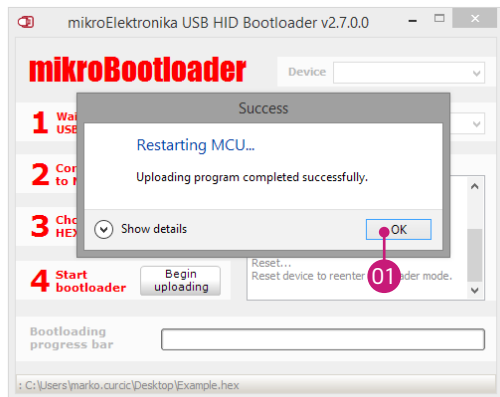

Restarting MCU

- 01 Click OK button after the uploading process is finished.
- 02 Press Reset button on 6LoWPAN clicker board and wait for 5 seconds. Your program will run automatically.



mikroBootloader ready for next job

Programming with mikroProg™ programmer

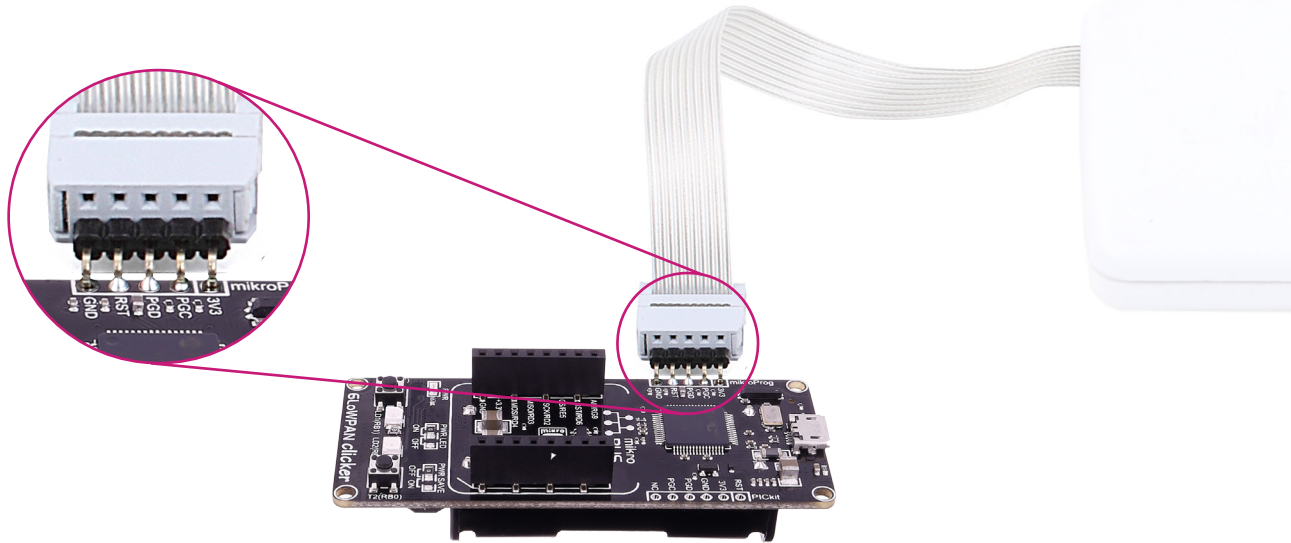

mikroProg™ connector

The microcontroller can be programmed with external mikroProg™ for PIC®, dsPIC® and PIC32® programmer and mikroProg Suite™ for PIC® software. The external programmer is connected to the development system via 1x5 mikroProg™ connector. mikroProg™ is a fast USB 2.0 programmer with hardware debugger support. It supports PIC10®, PIC12®, PIC16®, PIC18®, dsPIC30/33®, PIC24® and PIC32® devices from Microchip®. Outstanding performance, easy operation and elegant design are its key features.

7. mikroProg Suite™ for PIC® Software



The mikroProg programmer requires special programming software called mikroProg Suite for PIC®. It can be used for programming all Microchip® microcontroller families, including PIC10®, PIC12®, PIC16®, PIC18®, dsPIC30/33®, PIC24® and PIC32®. The software has intuitive interface and SingleClick™ programming technology. Just download the latest version of mikroProg Suite™ and your programmer is ready to program new devices. mikroProg Suite is updated regularly, at least four times a year, so your programmer will be more and more powerful with each new release.

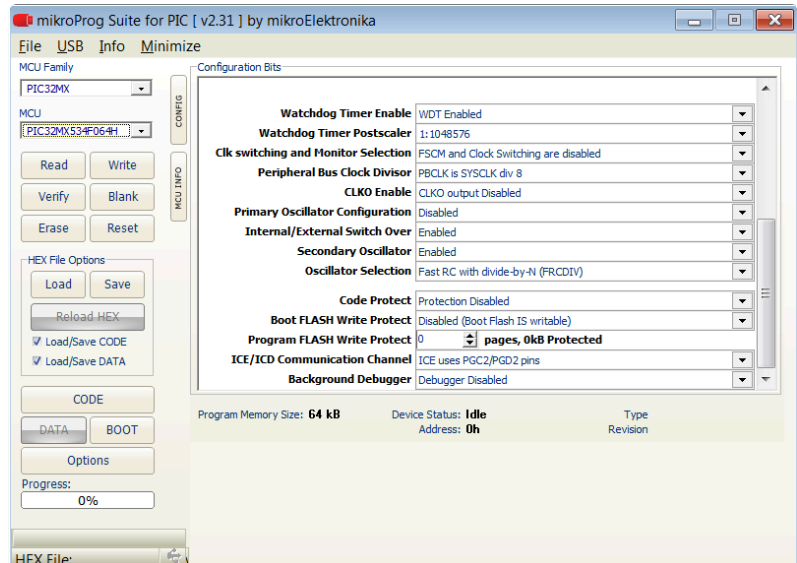

Main window of mikroProg Suite™ for PIC® programming software

Software Installation Wizard



01 Start Installation

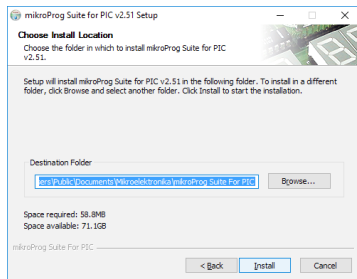

04 Choose destination folder

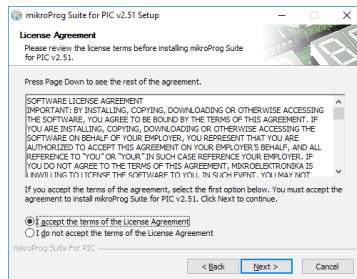

02 Accept EULA and continue

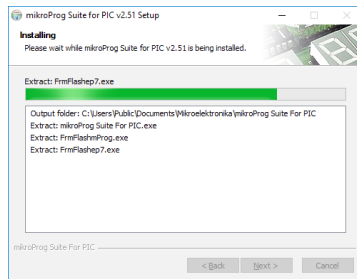

05 Installation in progress

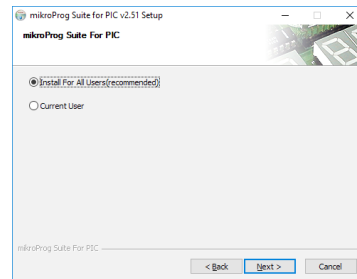

03 Install for all users

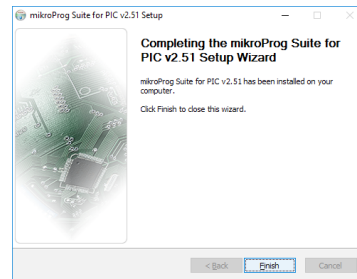

06 Finish installation

8. click boards are plug and play!

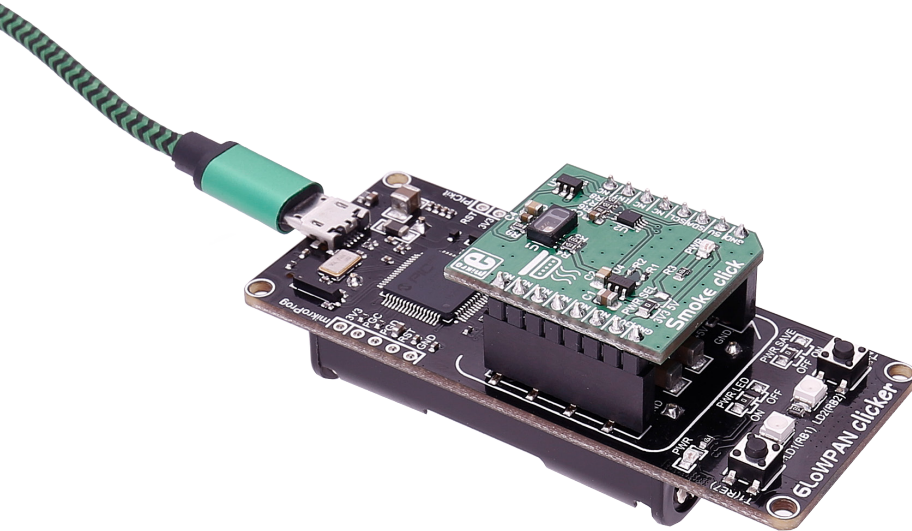

6LoWPAN clicker driving
Smoke click™ board

Up to now, MikroElektronika has released more than 300 mikroBUS™ compatible click™ boards. On the average, we make one click per day. It is our intention to provide you with as many add-on boards as possible, so you will be able to expand your development board with additional functionality. Each board comes with a set of working example codes. Please visit the click™ boards webpage for the complete list of currently available boards:

shop.mikroe.com/click

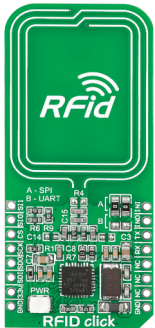

RFid click™

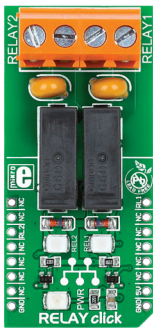

Relay click™

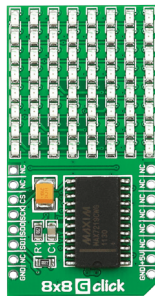

8x8 click™

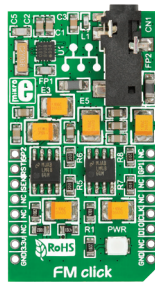

FM click™



Bluetooth2 click™



Thunder click™

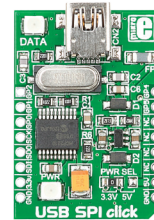

USB SPI click™

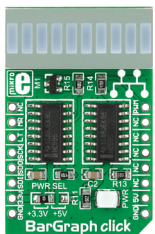

BarGraph click™

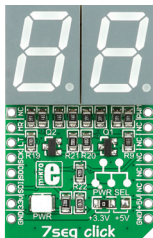

7seg click™

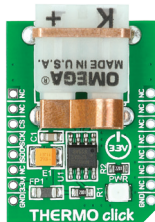

THERMO click™

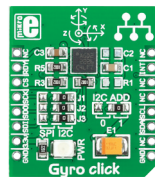

Gyro click™

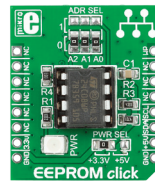

EEPROM click™

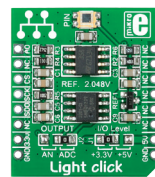

Light click™

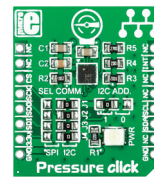

Pressure click™

9. Dimensions

Legend

-  mm
-  mils

Mounting hole size

- Ø2 mm
- Ø79 mils

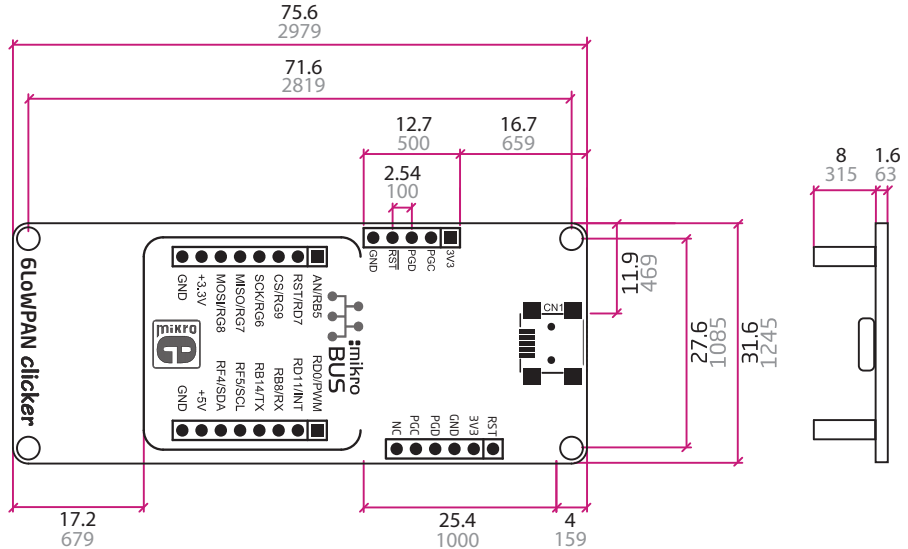

DISCLAIMER

All the products owned by MikroElektronika are protected by copyright law and international copyright treaty. Therefore, this manual is to be treated as any other copyright material. No part of this manual, including product and software described herein, may be reproduced, stored in a retrieval system, translated or transmitted in any form or by any means, without the prior written permission of MikroElektronika. The manual PDF edition can be printed for private or local use, but not for distribution. Any modification of this manual is prohibited.

MikroElektronika provides this manual 'as is' without warranty of any kind, either expressed or implied, including, but not limited to, the implied warranties or conditions of merchantability or fitness for a particular purpose.

MikroElektronika shall assume no responsibility or liability for any errors, omissions and inaccuracies that may appear in this manual. In no event shall MikroElektronika, its directors, officers, employees or distributors be liable for any indirect, specific, incidental or consequential damages (including damages for loss of business profits and business information, business interruption or any other pecuniary loss) arising out of the use of this manual or product, even if MikroElektronika has been advised of the possibility of such damages. MikroElektronika reserves the right to change information contained in this manual at any time without prior notice, if necessary.

HIGH RISK ACTIVITIES

The products of MikroElektronika are not fault – tolerant nor designed, manufactured or intended for use or resale as on – line control equipment in hazardous environments requiring fail – safe performance, such as in the operation of nuclear facilities, aircraft navigation or communication systems, air traffic control, direct life support machines or weapons systems in which the failure of Software could lead directly to death, personal injury or severe physical or environmental damage ('High Risk Activities'). MikroElektronika and its suppliers specifically disclaim any expressed or implied warranty of fitness for High Risk Activities.

TRADEMARKS

The MikroElektronika name and logo, mikroC™, mikroBasic™, mikroPascal™, Visual TFT™, Visual GLCD™, mikroProg™, Ready™, MINI™, mikroBUS™, EasyPIC™, EasyAVR™, Easy8051™, click™ boards and mikromedia™ are trademarks of MikroElektronika. All other trademarks mentioned herein are property of their respective companies. All other product and corporate names appearing in this manual may or may not be registered trademarks or copyrights of their respective companies, and are only used for identification or explanation and to the owners' benefit, with no intent to infringe.