

EXPAND 4 click

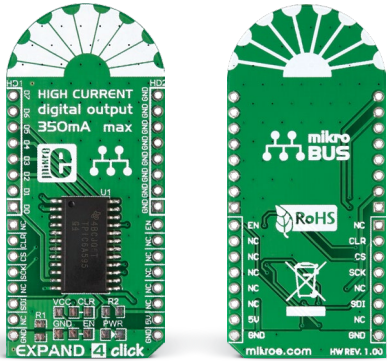

1. Introduction

Expand 4 click carries **TPCIC6A595**, a power logic 8-bit shift register. It's intended for use as a port expander for connecting high power peripherals (up to 50V/350-mA). The mikroBUS™ MOSI pin serves as the data input from the MCU, with SCK providing the clock, and CLR IN, CS and EN pin providing additional functionality. The output interface comprises 16 pins: DO-D7 outputs paired with 8 GND pins. Uses 5V power supply.

2. Soldering the headers

Before using your click board™, make sure to solder 1x8 male headers to both left and right side of the board. Two 1x8 male headers are included with the board in the package.

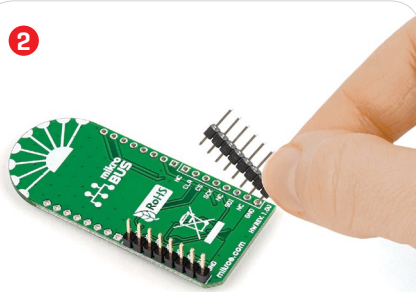
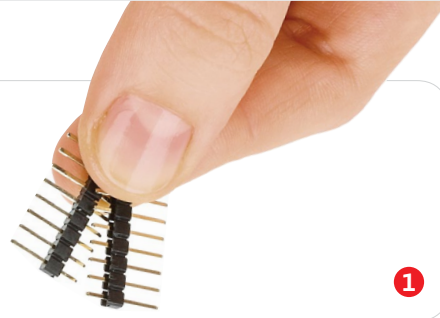

Turn the board upside down so that the bottom side is facing you upwards. Place shorter pins of the header into the appropriate soldering pads.

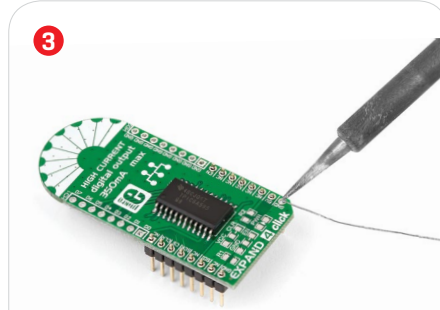

Turn the board upward again. Make sure to align the headers so that they are perpendicular to the board, then solder the pins carefully.

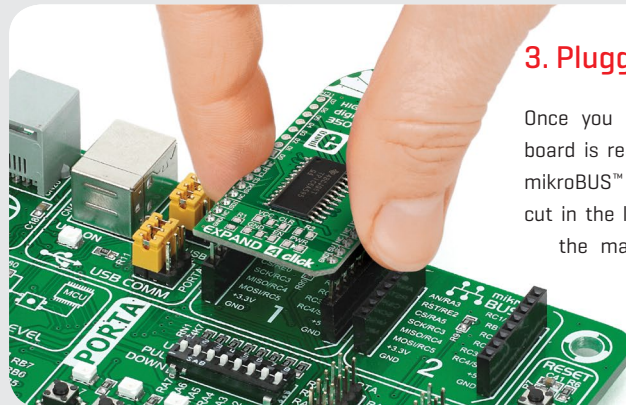

3. Plugging the board in

Once you have soldered the headers your board is ready to be placed into the desired mikroBUS™ socket. Make sure to align the cut in the lower-right part of the board with the markings on the silkscreen at the mikroBUS™ socket. If all the pins are aligned correctly, push the board all the way into the socket.

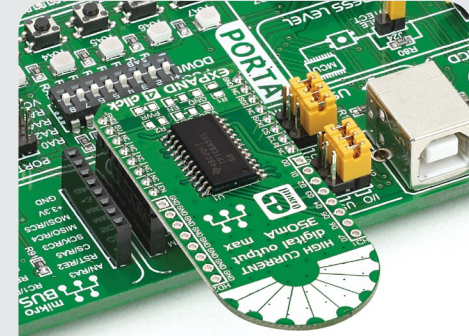

4. Essential features

The TPCIC6A595 chip combines an 8-bit serial-in, parallel-out shift register with an 8-bit D-type storage register. On the input side, *Expand 4 click* uses a SPI interface, with few additions. The CLR IN pin will clear all input shift registers when held low. The EN IN pin set all drain outputs to OFF when held high. The CS pin provides the impulse for shifting the data from the shift to the storage register. The outputs are open-drain transistor with continuous sink capability.

click
BOARD™
www.mikroe.com



EXPAND 4 click manual
ver 1.00



5. Schematic

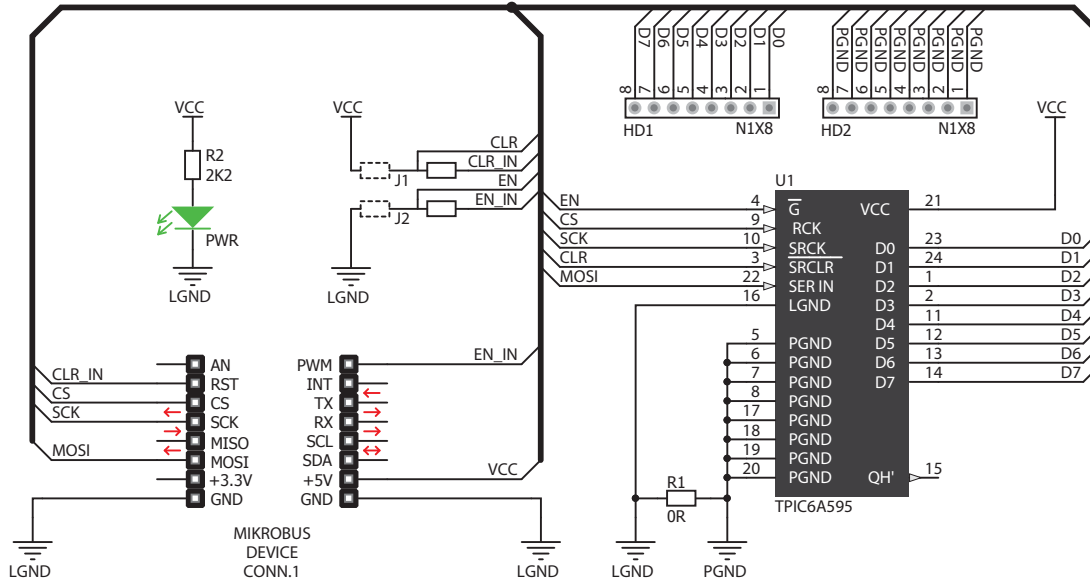

6. Dimensions

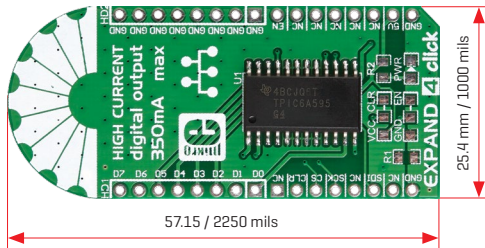

	mm	mils
LENGTH	57.15	2250
WIDTH	25.4	1000
HEIGHT*	4	157.5

* without headers

7. Alternative port expander clicks

If you don't require high power peripherals, you have three other Expand clicks to choose from.

See them at:

www.mikroe.com/click

8. Code examples

Once you have done all the necessary preparations, it's time to get your click board™ up and running. We have provided examples for mikroC™, mikroBasic™ and mikroPascal™ compilers on our **Libstock** website. Just download them and you are ready to start.



9. Support

MikroElektronika offers **free tech support** [www.mikroe.com/support] until the end of the product's lifetime, so if something goes wrong, we're ready and willing to help!



10. Disclaimer

MikroElektronika assumes no responsibility or liability for any errors or inaccuracies that may appear in the present document. Specification and information contained in the present schematic are subject to change at any time without notice.

Copyright © 2015 MikroElektronika.

All rights reserved.