

## Shake2Wake click

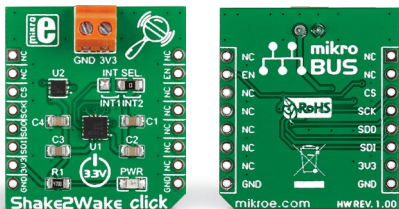

### 1. Introduction

Shake2Wake click carries an **ADXL362** ultralow power, **3-axis MEMS** accelerometer from Analog Devices. The distinguishing feature of this IC is that it incorporates several activity detection modes. The interrupt pins from the chip are connected to an onboard ADP195 power switch IC that in turn controls an external device connected through a screw terminal. Otherwise, Shake2Wake click communicates with the target MCU through mikroBUS™ SPI interface. Uses 3.3V power supply only.

### 2. Soldering the headers

Before using your click board™, make sure to solder 1x8 male headers to both left and right side of the board. Two 1x8 male headers are included with the board in the package.

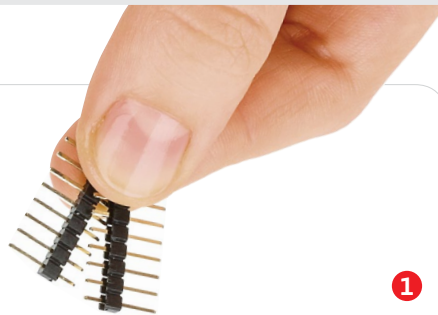

1

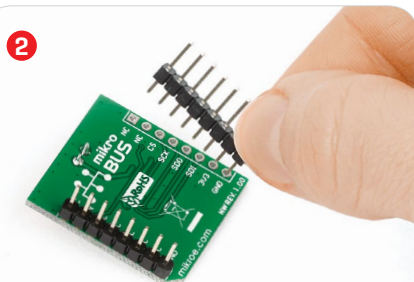

Turn the board upside down so that the bottom side is facing you upwards. Place shorter pins of the header into the appropriate soldering pads.

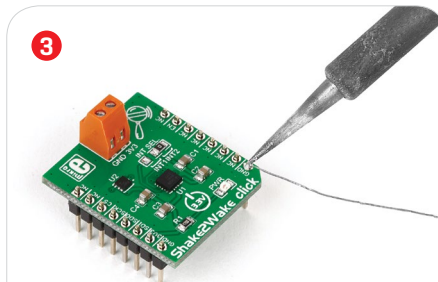

Turn the board upward again. Make sure to align the headers so that they are perpendicular to the board, then solder the pins carefully.

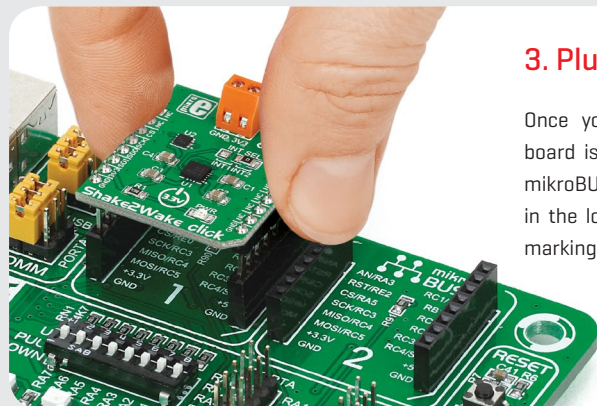

### 3. Plugging the board in

Once you have soldered the headers your board is ready to be placed into the desired mikroBUS™ socket. Make sure to align the cut in the lower-right part of the board with the markings on the silkscreen at the mikroBUS™ socket. If all the pins are aligned correctly, push the board all the way into the socket.

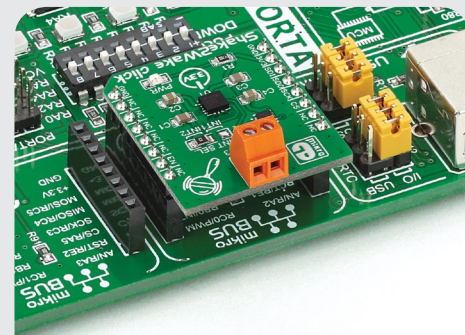

### 4. Essential features

Shake2Wake click has two main operating modes: “measuring” and “wake-up” To use it as a regular accelerometer, for continuous sensing, use the Measurement mode. Shake2Wake click outputs 12-bit resolution data [8-bit also available]. The **“wake-up” mode is for activity detection**, ideal for motion activated on/off switches. The detection threshold is configurable [both intensity and duration]. The duration of inactivity that leads to switching off is also programmable. In wake-up mode, the power consumption drops dramatically [270nA at 2V].

# click

## BOARDS™

[www.mikroe.com](http://www.mikroe.com)



Shake2Wake click Manual v100



0100000089453

## 5. Schematic

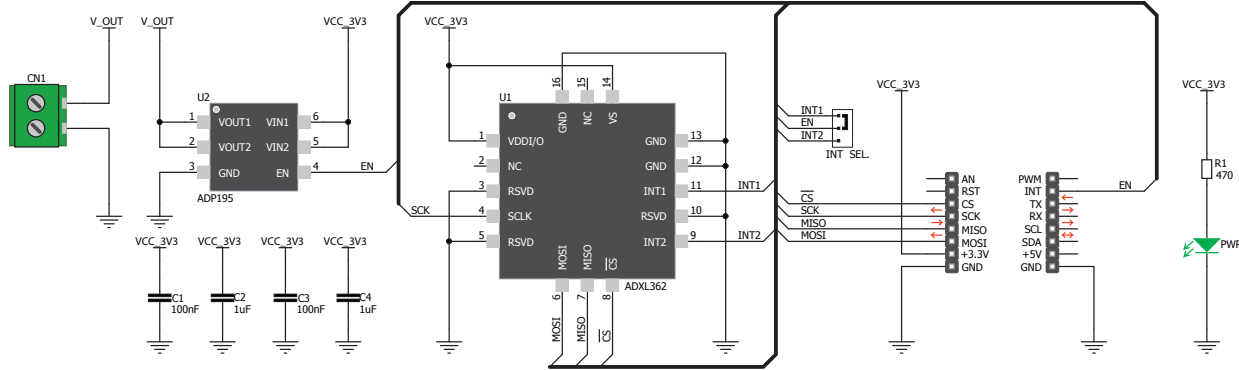

## 6. Dimensions

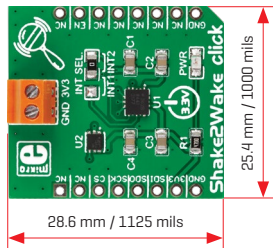

	mm	mils
LENGTH	28.6	1125
WIDTH	25.4	1000
HEIGHT*	3.3	130

\* without headers

## 7. Interrupt selection



Shak2Wake click features an INT SEL.

jumper for specifying which of the available interrupt pins are utilized (the specified pin is connected both to the onboard power switch as well as to the mikroBUS™ socket).

## 8. Code examples

Once you have done all the necessary preparations, it's time to get your click board™ up and running. We have provided examples for mikroC™, mikroBasic™ and mikroPascal™ compilers on our **Libstock** website. Just download them and you are ready to start.



## 9. Support

MikroElektronika offers **free tech support** [[www.mikroe.com/support](http://www.mikroe.com/support)] until the end of the product's lifetime, so if something goes wrong, we're ready and willing to help!



## 10. Disclaimer

MikroElektronika assumes no responsibility or liability for any errors or inaccuracies that may appear in the present document. Specification and information contained in the present schematic are subject to change at any time without notice.

Copyright © 2015 MikroElektronika.  
All rights reserved.