

COLOR 2 click

2. Soldering the headers

Before using your click board™, make sure to solder 1x8 male headers to both left and right side of the board. Two 1x8 male headers are included with the board in the package.

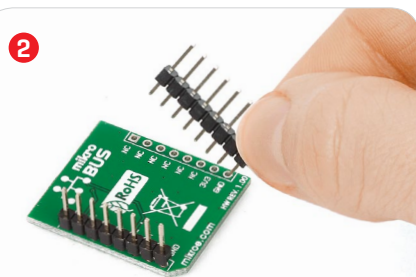
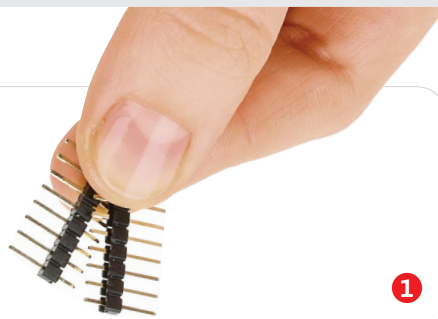

Turn the board upside down so that the bottom side is facing you upwards. Place shorter pins of the header into the appropriate soldering pads.

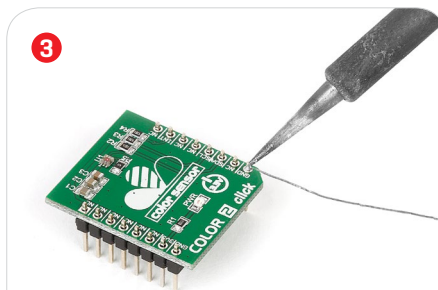

Turn the board upward again. Make sure to align the headers so that they are perpendicular to the board, then solder the pins carefully.

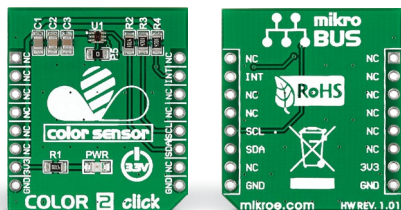

1. Introduction

Color 2 click carries the **ISL29125 RGB** color light sensor from Intersil. The photodiode detects red, green and blue in a variety of lighting conditions, outputting 16-bit resolution data in a 5.7m lux-10,000 lux measuring range. Color 2 click communicates with the target MCU through the mikroBUS™ I2C interface (SCL and SDA pins). A programmable interrupt pin is also available. The board is designed to use a 3.3V power supply only.

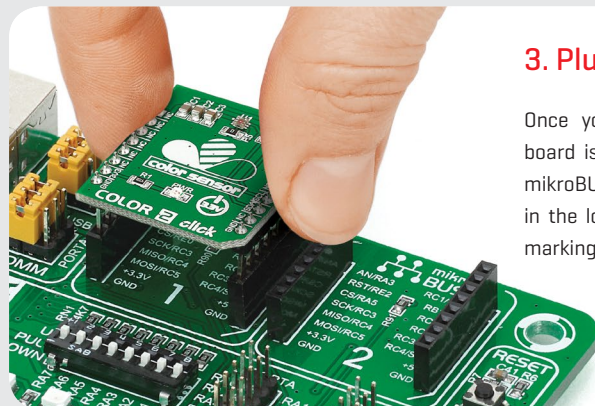

3. Plugging the board in

Once you have soldered the headers your board is ready to be placed into the desired mikroBUS™ socket. Make sure to align the cut in the lower-right part of the board with the markings on the silkscreen at the mikroBUS™ socket. If all the pins are aligned correctly, push the board all the way into the socket.

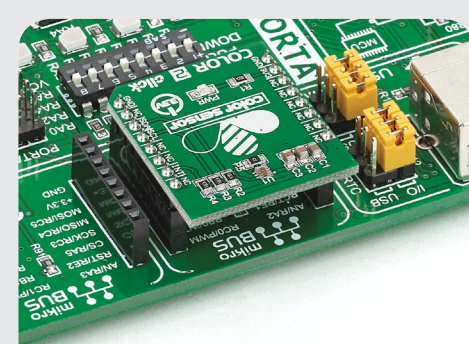

4. Essential features

The ISL29125 IC on Color 2 click has two selectable measurement ranges and two selectable, corresponding output resolutions. When using the board in the narrower 5.7 m lux-375 lux range, a 12-bit resolution is optimal. The wider 0.152 to 10,000 lux range calls for a 16-bit output. The sensor also incorporates an IR blocking filter, allowing Color 2 click to work even under a dark glass cover. The integrated ADC also rejects 50Hz and 60Hz flicker from artificial light sources, further increasing the reliability of the sensor.

click
BOARDS™
www.mikroe.com



COLOR 2 Manual v100



010000089651

5. Schematic

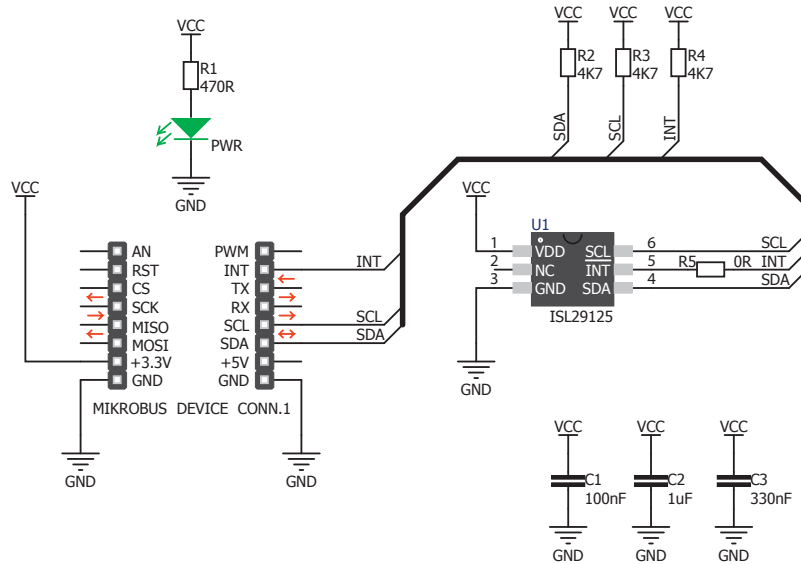

6. Dimensions

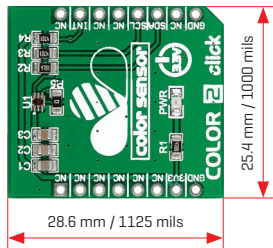

	mm	mils
LENGTH	28.6	1125
WIDTH	25.4	1000
HEIGHT*	3.3	130

* without headers

7. COLOR 2 click alternatives

For a different sensor with similar functionality, see the original *Color click*

www.mikroe.com/click/color

8. Code examples

Once you have done all the necessary preparations, it's time to get your click board™ up and running. We have provided examples for mikroC™, mikroBasic™ and mikroPascal™ compilers on our **Libstock** website. Just download them and you are ready to start.



9. Support

MikroElektronika offers **free tech support** [www.mikroe.com/support] until the end of the product's lifetime, so if something goes wrong, we're ready and willing to help!



10. Disclaimer

MikroElektronika assumes no responsibility or liability for any errors or inaccuracies that may appear in the present document. Specification and information contained in the present schematic are subject to change at any time without notice.

Copyright © 2015 MikroElektronika.
All rights reserved.