

Charger click

2. Soldering the headers

Before using your click board™, make sure to solder 1x8 male headers to both left and right side of the board. Two 1x8 male headers are included with the board in the package.

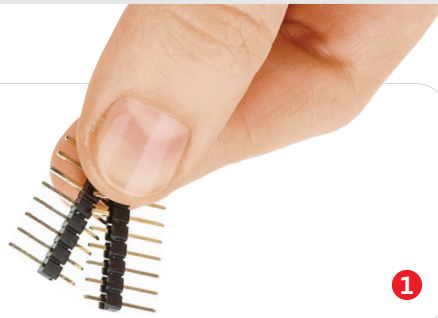

2

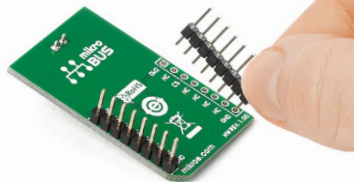

Turn the board upside down so that the bottom side is facing you upwards. Place shorter pins of the header into the appropriate soldering pads.

3

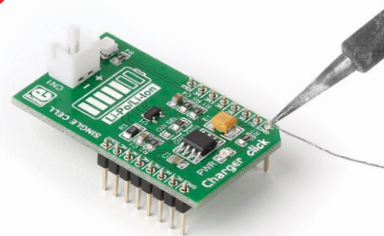

Turn the board upward again. Make sure to align the headers so that they are perpendicular to the board, then solder the pins carefully.

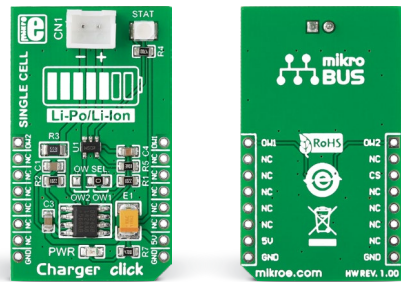

1. Introduction

Charger click carries both a battery charger controller and a battery charge monitor. The smaller chip is **MCP73831**, a miniature **single-cell** Li-Ion and Li-Polymer charge management controller. The larger IC is DS2438, a smart battery monitor. The monitor communicates with the target MCU through a 1-Wire interface. The battery connector is on top of the board. Charger click is designed to use a 5V power supply.

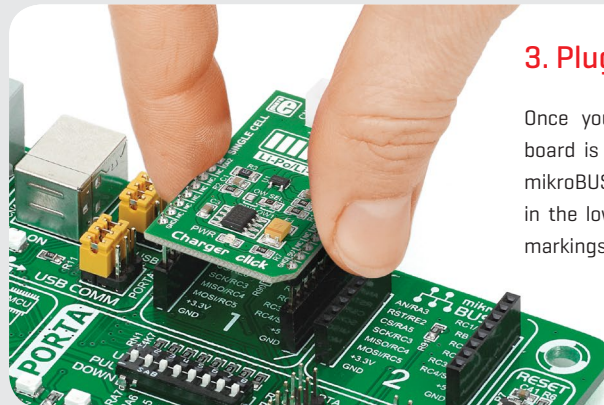

3. Plugging the board in

Once you have soldered the headers your board is ready to be placed into the desired mikroBUS™ socket. Make sure to align the cut in the lower-right part of the board with the markings on the silkscreen at the mikroBUS™ socket. If all the pins are aligned correctly, push the board all the way into the socket.

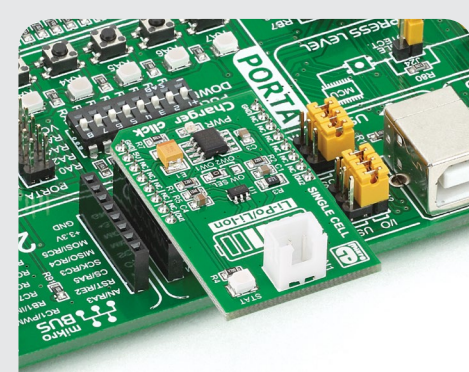

4. Essential features

Maxim's DS2438 Smart Battery Monitor integrates a temperature sensor, a timer, an ADC to measure the battery voltage and current, and a current accumulator that monitors the total amount of current going into and out of the battery. Also, 40 bytes of EEPROM is available for storing important parameters about the battery (chemistry, capacity etc.). Several units can work on a same 1-Wire bus because each DS2438 has a unique ID. The MCP73831 has a programmable charge current from 15 to 250 mA.

click
BOARDS™
www.mikroe.com



Charger click Manual v100



010000092835

5. Schematic

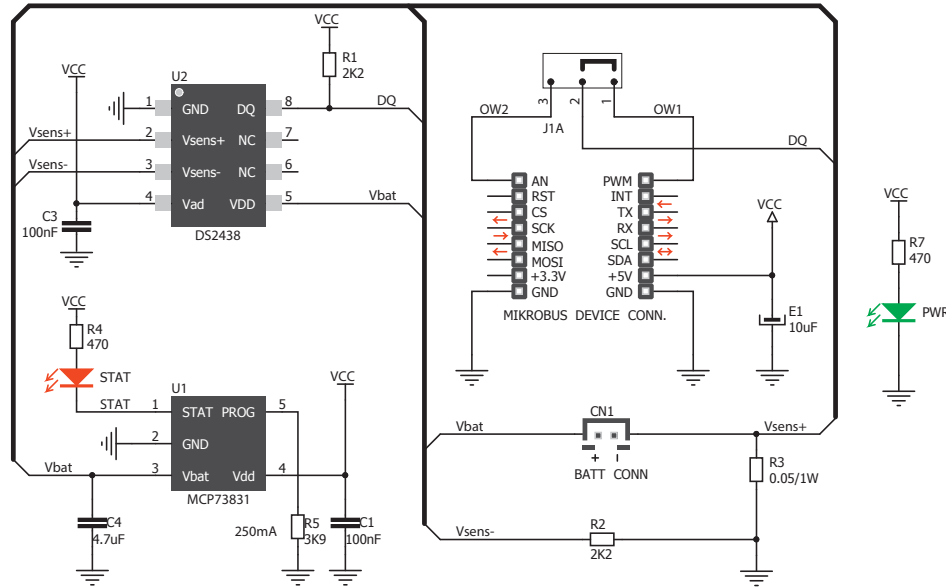

6. Dimensions

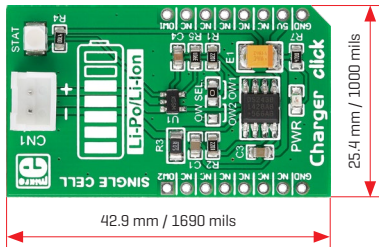

	mm	mils
LENGTH	42.9	1690
WIDTH	25.4	1000
HEIGHT*	3.9	154

* without headers

7. 0W jumper



The board features an 0W jumper [zero ohm resistor] that allows you to choose between two available pins for the 1-Wire interface.

8. Code examples

Once you have done all the necessary preparations, it's time to get your click board™ up and running. We have provided examples for mikroC™, mikroBasic™ and mikroPascal™ compilers on our **Libstock** website. Just download them and you are ready to start.



9. Support

MikroElektronika offers **free tech support** [www.mikroe.com/support] until the end of the product's lifetime, so if something goes wrong, we're ready and willing to help!



10. Disclaimer

MikroElektronika assumes no responsibility or liability for any errors or inaccuracies that may appear in the present document. Specification and information contained in the present schematic are subject to change at any time without notice.

Copyright © 2016 MikroElektronika.
All rights reserved.