

RTC 6 click

2. Soldering the headers

Before using your click board™, make sure to solder 1x8 male headers to both left and right side of the board. Two 1x8 male headers are included with the board in the package.

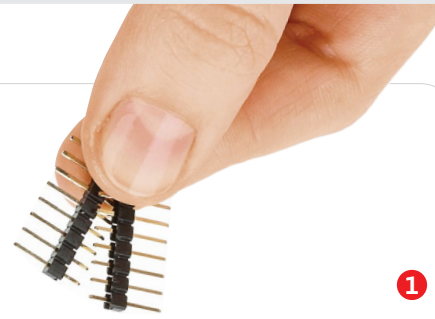

1

2

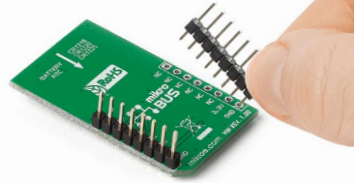

Turn the board upside down so that the bottom side is facing you upwards. Place shorter pins of the header into the appropriate soldering pads.

3

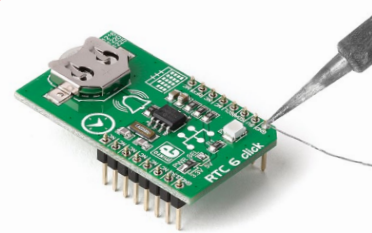

Turn the board upward again. Make sure to align the headers so that they are perpendicular to the board, then solder the pins carefully.

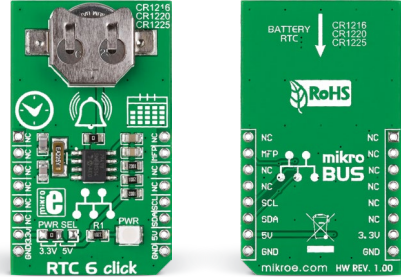

1. Introduction

RTC6 click carries Microchip's **MCP79410** Real-Time Clock/Calendar IC. The clock frequency is derived from an onboard 32.768KHz crystal oscillator. Backup power is supplied by a coin-cell Lithium battery. RTC6 communicates with the target board MCU through the mikroBUS™ I2C interface [SCL, SDA] along with a multifunction pin [MFP, in place of default mikroBUS™ INT pin]. The board is designed to use either a 3.3V or a 5V power supply.

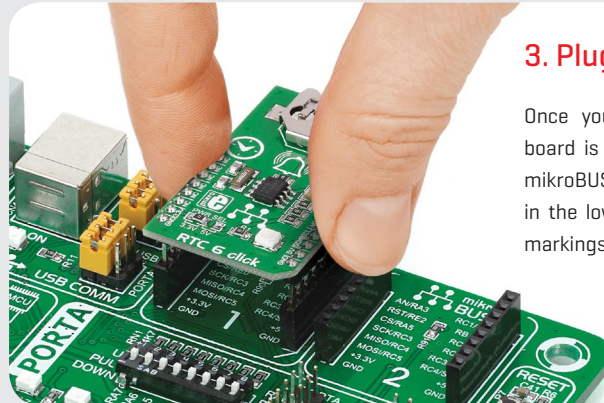

3. Plugging the board in

Once you have soldered the headers your board is ready to be placed into the desired mikroBUS™ socket. Make sure to align the cut in the lower-right part of the board with the markings on the silkscreen at the mikroBUS™ socket. If all the pins are aligned correctly, push the board all the way into the socket.

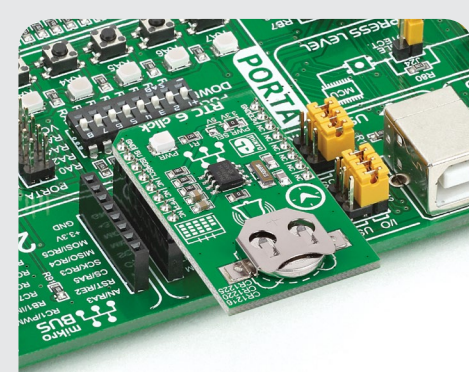

4. Essential features

RTC6 click can be used to track hours, minutes, seconds, days, months, years, and weekdays. Leap years are compensated until 2399. For storing data, the **MCP79411** has **64 bytes** of battery-backed SRAM. The chip also features an additional kilobit of EEPROM. Additional **64 bits** of protected EEPROM requires an unlock sequence to be unlocked, which makes it suitable for storing a unique ID or other critical information. The multifunction pin [MFP] can be configured as an alarm, a square wave frequency output, or a general purpose output.



RTC6 click Manual v100



010000092880

5. Schematic

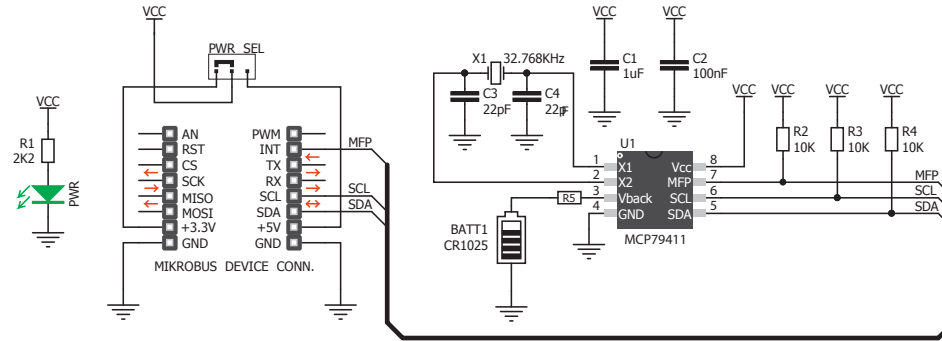

6. Dimensions

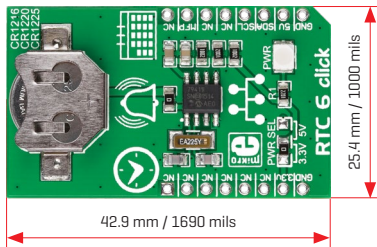

	mm	mils
LENGTH	42.9	1690
WIDTH	25.4	1000
HEIGHT*	3.9	154

* without headers

7. SMD jumper

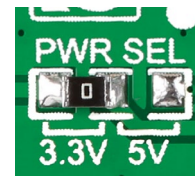

RTC6 click features an SMD jumper (zero ohm resistor) that let's you switch between a 3.3V or a 5V power supply.

8. Code examples

Once you have done all the necessary preparations, it's time to get your click board™ up and running. We have provided examples for mikroC™, mikroBasic™ and mikroPascal™ compilers on our **Libstock** website. Just download them and you are ready to start.



9. Support

MikroElektronika offers **free tech support** (www.mikroe.com/support) until the end of the product's lifetime, so if something goes wrong, we're ready and willing to help!



10. Disclaimer

MikroElektronika assumes no responsibility or liability for any errors or inaccuracies that may appear in the present document. Specification and information contained in the present schematic are subject to change at any time without notice.

Copyright © 2016 MikroElektronika.
All rights reserved.