

a great idea is just a click away

# CEC1702 clicker

A compact development board with a mikroBUS™ socket for click board connectivity and Microchip's CEC1702, a 32-bit ARM® Cortex™ -M4 Processor Core, with strong cryptographic support.

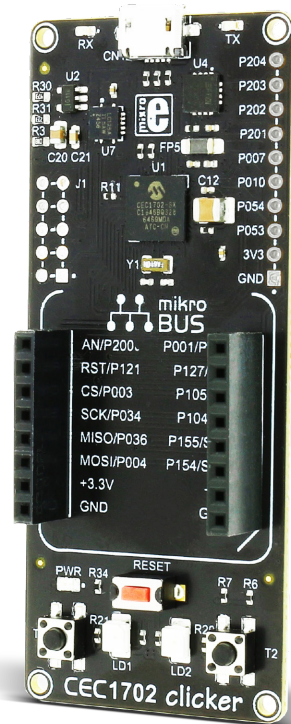

# TO OUR VALUED CUSTOMERS

I want to express my thanks to you for being interested in our products and for having confidence in MikroElektronika.

The primary aim of our company is to design and produce high quality electronic products and to constantly improve the performance thereof in order to better suit your needs.

A white, stylized handwritten signature on a dark green background. The signature is fluid and cursive, starting with a large 'N' and ending with a long horizontal stroke.

Nebojsa Matic  
General Manager

# Table of contents

1. What is CEC1702 clicker?	4	5. Buttons and LEDs	13
2. Power supply	6	6. click™ boards are plug and play!	15
3. CEC1702 microcontroller	8	7. Dimensions	17
Key microcontroller features	8		
4. Programming the microcontroller	9		
Programming with mikroProg™ programmer	10		
mikroProg Suite™ for ARM® software	11		

# What is CEC1702 clicker?

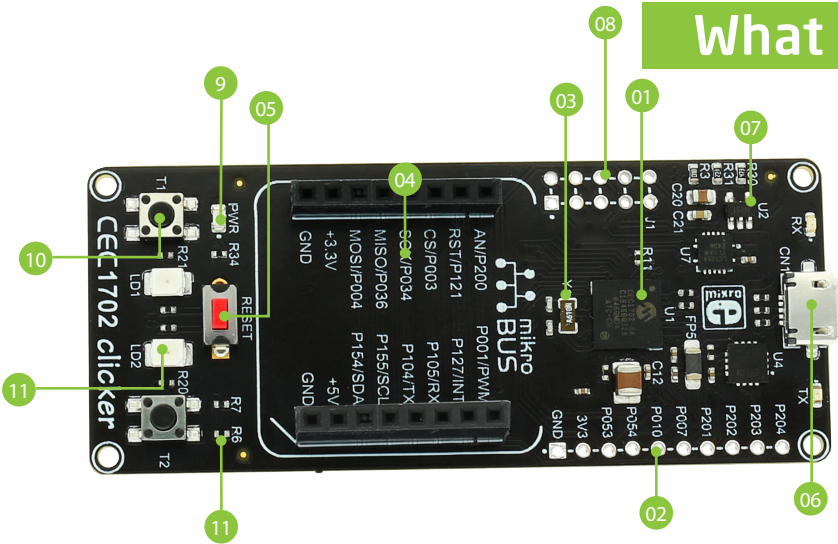

- 01 32-pin CEC1702 MCU
- 02 Connection pads
- 03 Crystal oscillator
- 04 mikroBUS™ socket
- 05 RESET button
- 06 Micro USB connector
- 07 3.3V Voltage regulator
- 08 JTAG Programmer connector
- 09 Power indication LED
- 10 Additional buttons
- 11 Additional LEDs

Figure 1-1: CEC1702 clicker

Add a mikroBUS™ socket to your favorite microcontroller. clicker for CEC1702 is a compact development board™ with a mikroBUS™ socket for click board™ connectivity. We have more than 270 click boards™ so far, you can add new functionalities to your project without limitations. The board features CEC1702, a 32-bit ARM® Cortex™ -M4 Processor Core, with strong cryptographic support. As well as two indication LEDs, two general purpose buttons, reset button, Micro USB connector and a single mikroBUS™ host socket. mikroProg connector and pads for interfacing with external electronics are provided as well. mikroBUS™ host connector consists of two 1x8 female headers with SPI, I<sup>2</sup>C, UART, RST, PWM, Analog and Interrupt lines as well as 3.3V, 5V and GND power lines. clicker for CEC1702 board can be powered over a USB cable. On-board power circuitry generates 3.3V and 5V power supply.

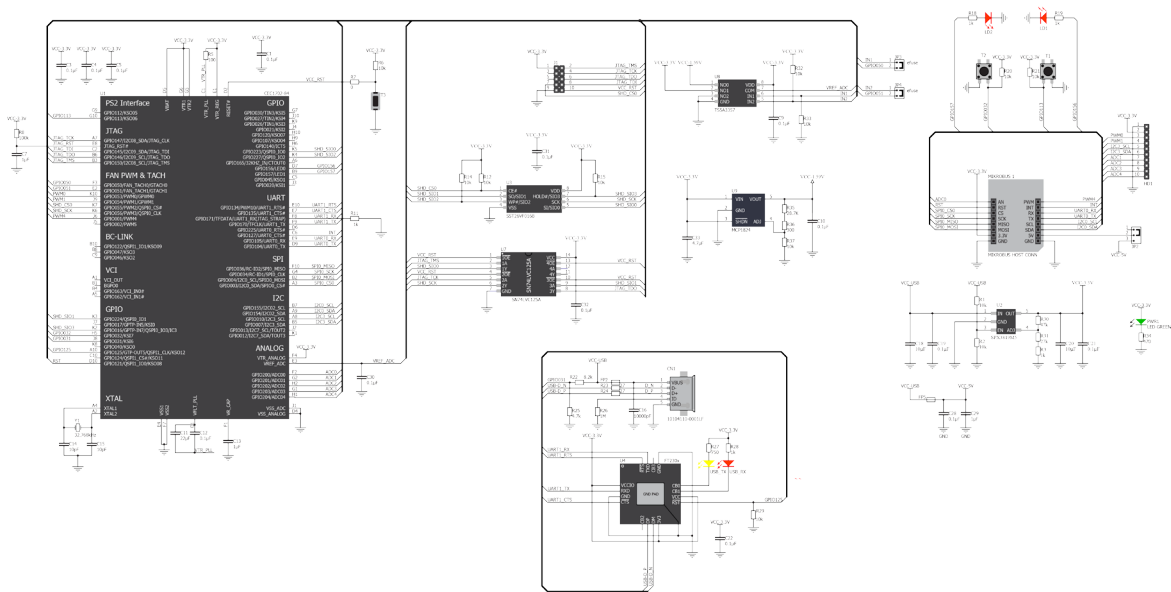
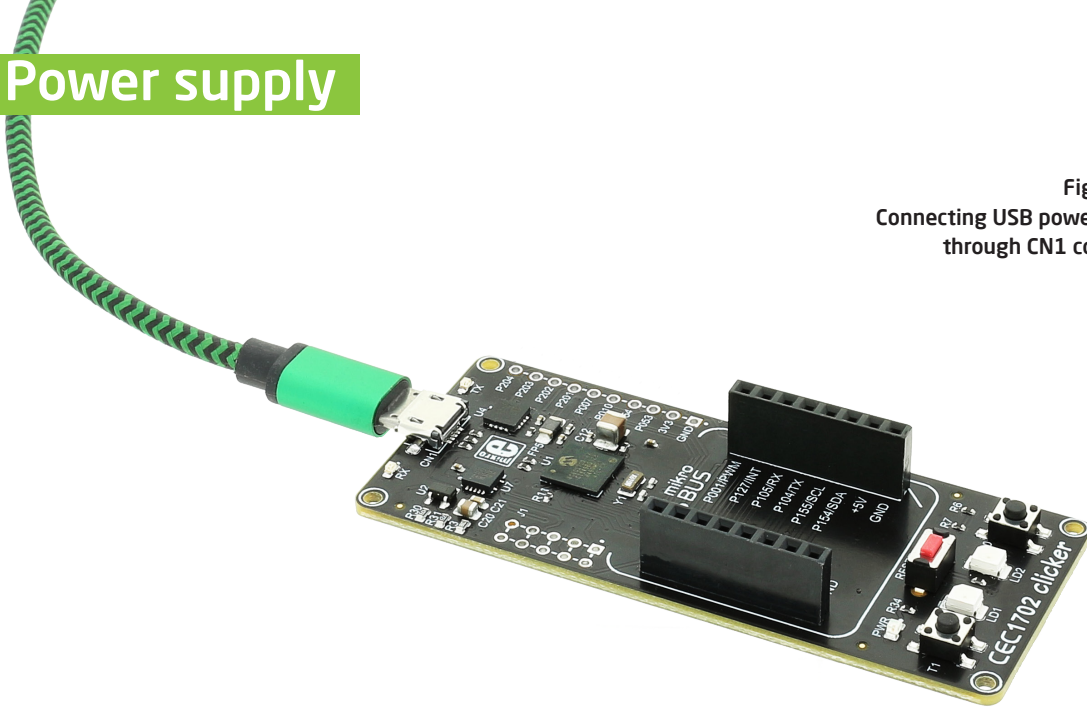

Figure 1-2:  
CEC1702 clicker  
schematic

## 2. Power supply

Figure 2-1:  
Connecting USB power supply  
through CN1 connector



When the board is powered up the power indication LED will be automatically turned on. The USB connection can provide up to 500mA of current which is more than enough for the operation of all on-board and additional modules.

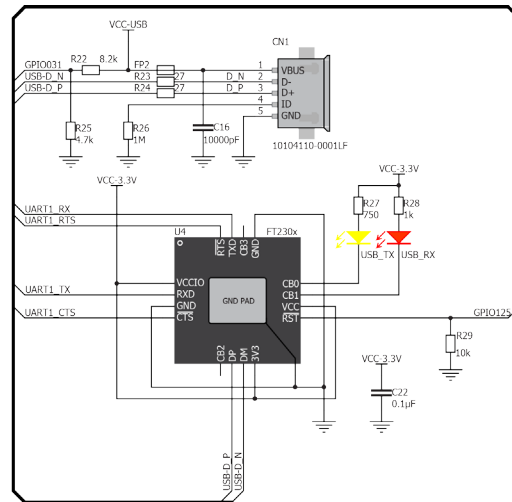
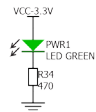
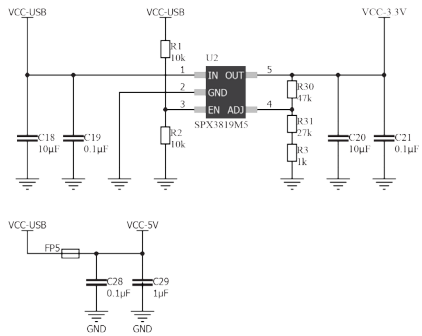

Figure 2-2: Power supply schematic

# 3. CEC1702 microcontroller

The clicker for CEC1702 development board comes with the CEC1702 microcontroller from Microchip. The CEC1702 is a full-featured ARM® Cortex®-M4-based microcontroller with a complete hardware cryptography-enabled solution in a single package. This low-power but powerful, programmable 32-bit microcontroller offers easy-to-use encryption, authentication, private and public key capabilities and allows customer programming flexibility to minimize customer risk.

## Key microcontroller features

- 480KB SRAM: Code + Data
- Robust HW Crypto Cypher Suite
- 2.5K bits User Programmable OTP
- Secure boot provides a HW-based root of trust
- Security Supervisor
- Can replace or supplement existing

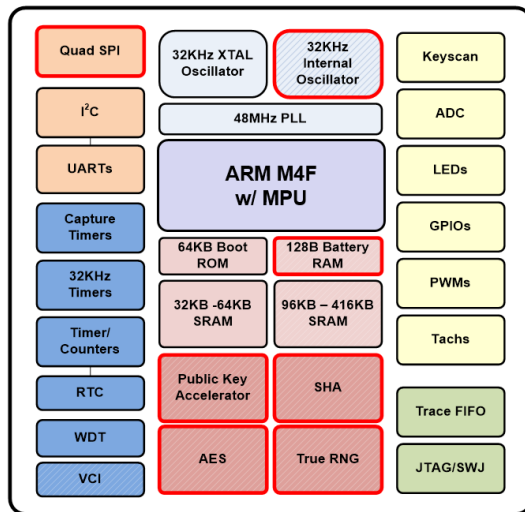



## 4. Programming the microcontroller



Figure 4-1:  
CEC1702  
microcontroller

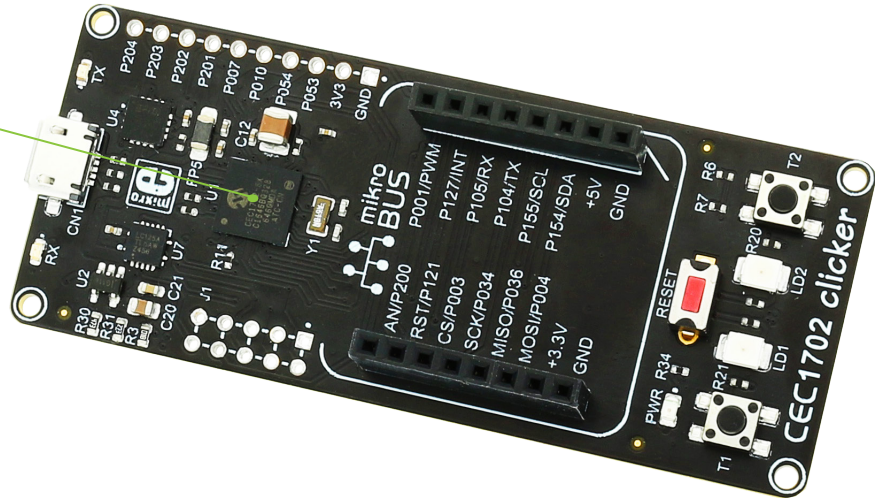

The microcontroller can be programmed using external mikroProg™ for CEC1702 programmer.

# Programming with mikroProg™ programmer

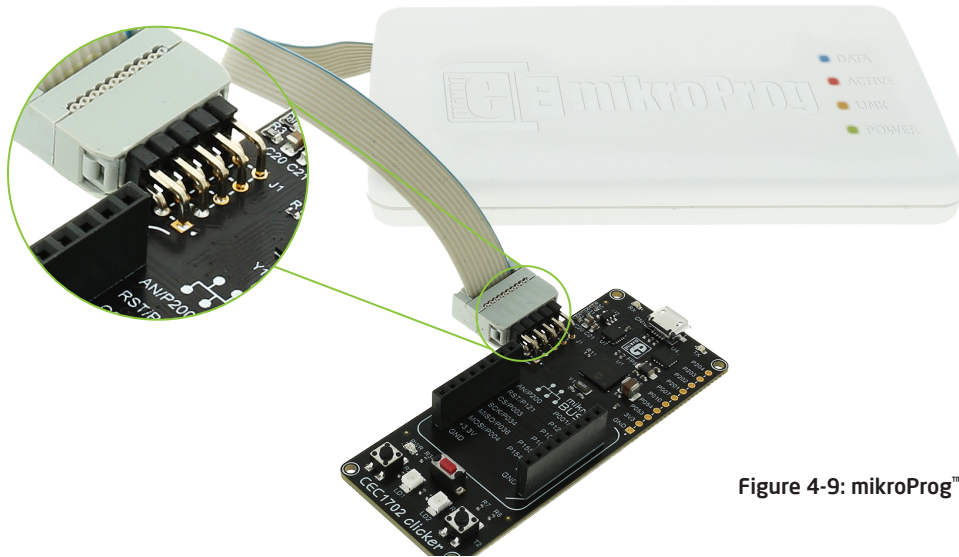

Figure 4-9: mikroProg™ connector

The microcontroller can be programmed with external **mikroProg™ for CEC1702 programmer** and **mikroProg Suite™ for ARM® software**.

# mikroProg Suite™ for ARM® software

On-board mikroProg™ programmer requires special programming software called mikroProg Suite™ for ARM®. This software is used for programming of all supported microcontroller families with ARM® Cortex™-M3 and Cortex™-M4 cores. The software has an intuitive interface and SingleClick™ programming technology. To begin, first locate the installation archive on the link below:



[http://www.mikroe.com/downloads/get/1809/mikroprog\\_suite\\_for\\_arm.zip](http://www.mikroe.com/downloads/get/1809/mikroprog_suite_for_arm.zip)

After downloading, extract the package and double click the executable setup file, to start installation.

## Quick guide

- 01 Click the **Detect MCU** button in order to recognize the device ID.
- 02 Click the **Read** button to read the entire microcontroller memory. You can click the **Save** button to save it to the target HEX file.
- 03 If you want to write the HEX file into the microcontroller, first make sure to load the target HEX file using the **Load** button. Then click the **Write** button to begin programming.
- 04 Click the **Erase** button to clear the microcontroller memory.

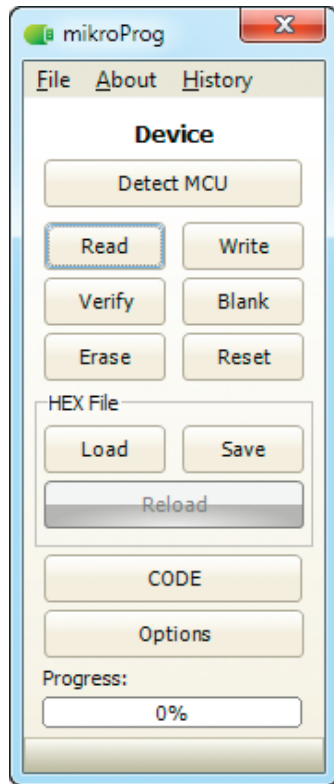

Figure 4-10:  
mikroProg Suite™  
for ARM® window

**NOTE** Before attaching the programming connector, you have to solder the provided 2x5 male header to the JTAG (J1) pads.

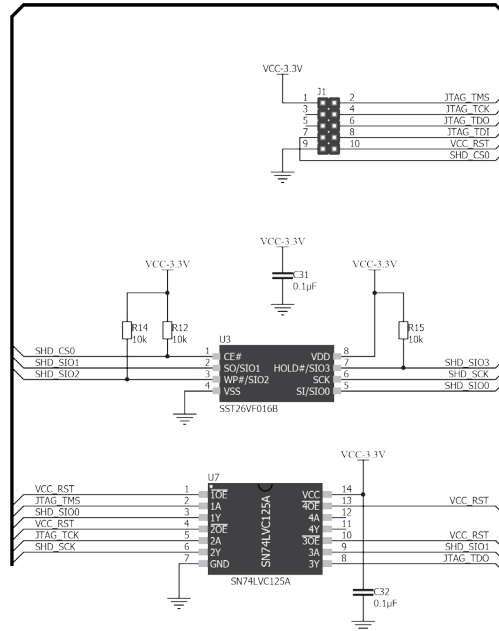

Figure 4-13: mikroProg™ connection schematic

## 5. Buttons and LEDs

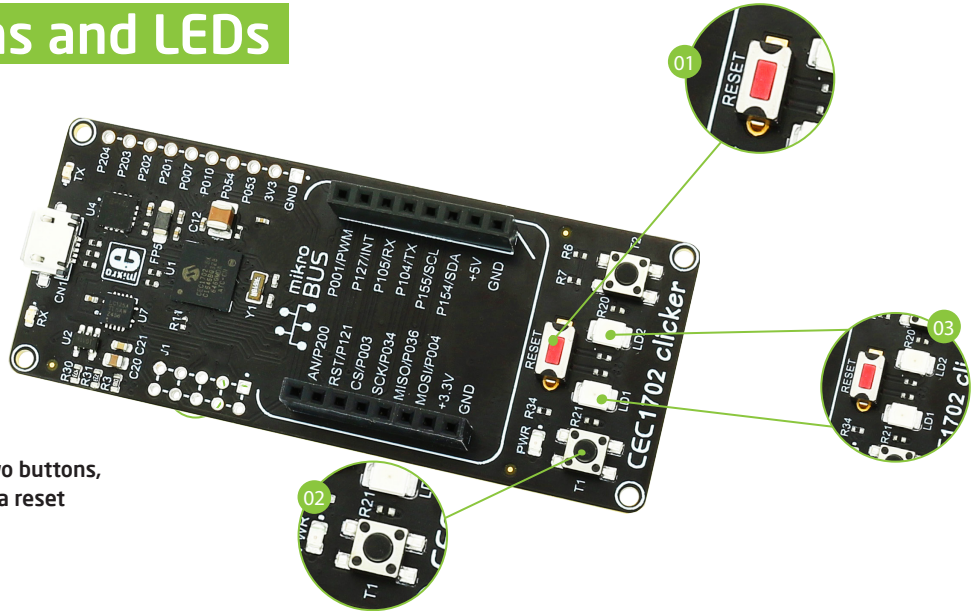

Figure 5-1: Two buttons, two LEDs and a reset button

The board also contains a **01 reset button** and a pair of **02 buttons** and **03 LEDs**. Each of these additional peripherals are located in the bottom area of the board. **Reset button** is used to manually reset the microcontroller. Pressing the reset button will generate a low voltage level on microcontroller's reset pin. **LEDs** can be used for visual indication of the logic state on two pins (**GPIO156** and **GPIO157**). An active LED indicates that a logic high (1) is present on the pin. Pressing any of these **buttons** can change the logic state of the microcontroller pins (**GPIO032** and **GPIO113**) from logic high (1) to logic low (0).

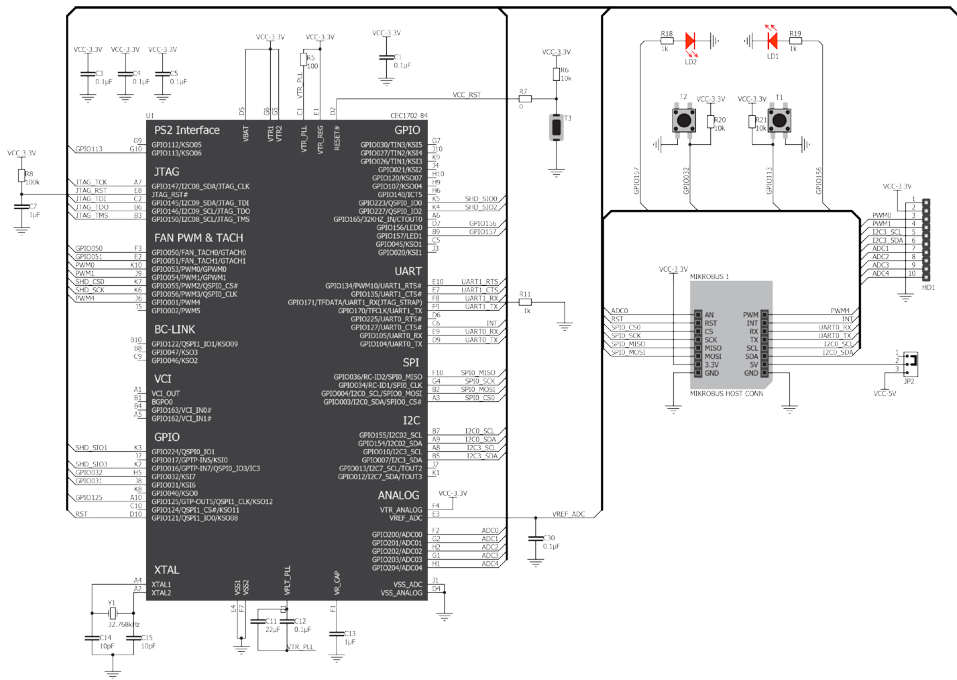

Figure 5-2: Other modules connection schematic

## 6. click boards are plug and play!

Up to now, MikroElektronika has released more than 270 mikroBUS™ compatible **click™ Boards**. On the average, two click boards are released per week. It is our intention to provide you with as many add-on boards as possible, so you will be able to expand your development board with additional functionality. Each board comes with a set of working example code. Please visit the click™ boards webpage for the complete list of currently available boards:



<https://shop.mikroe.com/click>

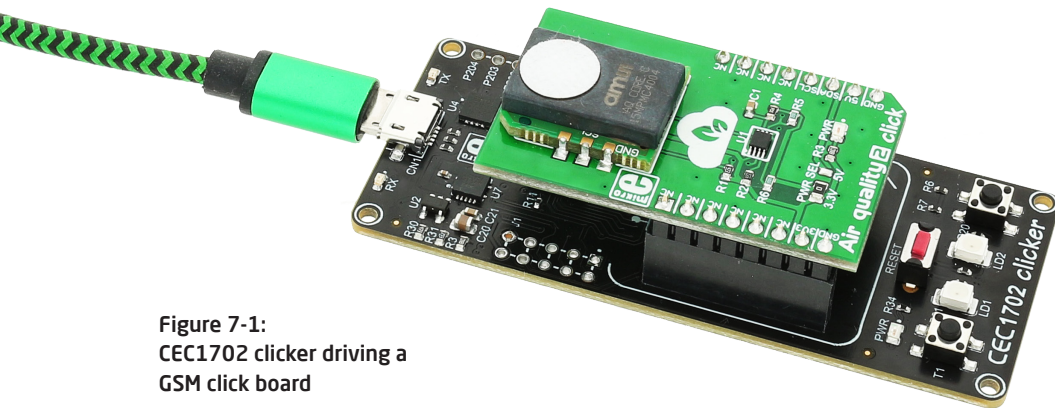
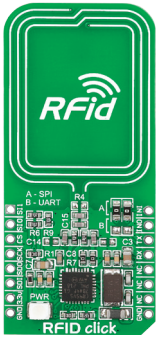
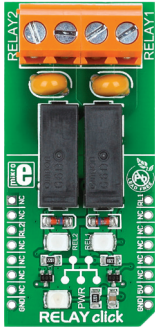

Figure 7-1:  
CEC1702 clicker driving a  
GSM click board



RFid click™



Relay click™

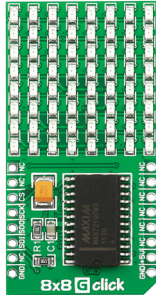

Bx8 click™

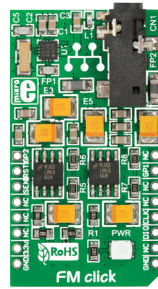

FM click™



Bluetooth2 click™

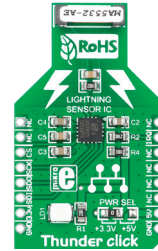

Thunder click™

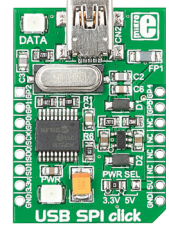

USB SPI click™

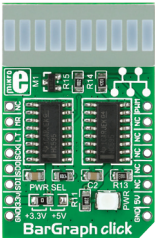

BarGraph click™

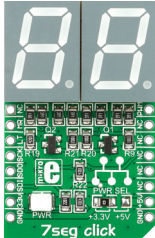

7seg click™



THERMO click™

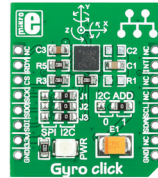

Gyro click™

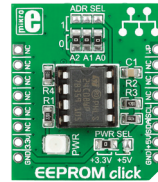

EEPROM click™

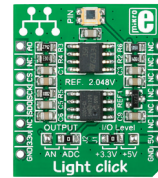

LightHz click™

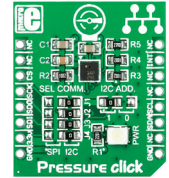

Pressure click™



# 7. Dimensions

## Legend

mm  
 mils

## Mounting hole size

∅2 mm  
 ∅79 mils

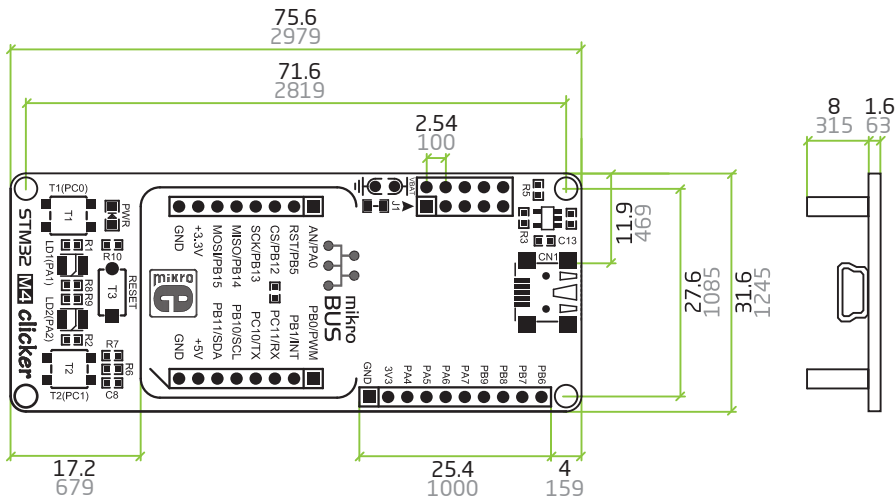

## DISCLAIMER

All the products owned by MikroElektronika are protected by copyright law and international copyright treaty. Therefore, this manual is to be treated as any other copyright material. No part of this manual, including product and software described herein, may be reproduced, stored in a retrieval system, translated or transmitted in any form or by any means, without the prior written permission of MikroElektronika. The manual PDF edition can be printed for private or local use, but not for distribution. Any modification of this manual is prohibited.

MikroElektronika provides this manual 'as is' without warranty of any kind, either expressed or implied, including, but not limited to, the implied warranties or conditions of merchantability or fitness for a particular purpose.

MikroElektronika shall assume no responsibility or liability for any errors, omissions and inaccuracies that may appear in this manual. In no event shall MikroElektronika, its directors, officers, employees or distributors be liable for any indirect, specific, incidental or consequential damages (including damages for loss of business profits and business information, business interruption or any other pecuniary loss) arising out of the use of this manual or product, even if MikroElektronika has been advised of the possibility of such damages. MikroElektronika reserves the right to change information contained in this manual at any time without prior notice, if necessary.

## HIGH RISK ACTIVITIES

The products of MikroElektronika are not fault - tolerant nor designed, manufactured or intended for use or resale as on - line control equipment in hazardous environments requiring fail - safe performance, such as in the operation of nuclear facilities, aircraft navigation or communication systems, air traffic control, direct life support machines or weapons systems in which the failure of Software could lead directly to death, personal injury or severe physical or environmental damage ('High Risk Activities'). MikroElektronika and its suppliers specifically disclaim any expressed or implied warranty of fitness for High Risk Activities.

## TRADEMARKS

The MikroElektronika name and logo, mikroC™, mikroBasic™, mikroPascal™, Visual TFT™, Visual GLCD™, mikroProg™, Ready™, MINI™, mikroBUS™, EasyPIC™, EasyAVR™, Easy8051™, click™ boards and mikromedia™ are trademarks of MikroElektronika. All other trademarks mentioned herein are property of their respective companies. All other product and corporate names appearing in this manual may or may not be registered trademarks or copyrights of their respective companies, and are only used for identification or explanation and to the owners' benefit, with no intent to infringe.

Copyright © 2014 MikroElektronika. All Rights Reserved.