

StartUSB for PIC™

Manual

All MikroElektronika's development systems represent irreplaceable tools for programming and developing microcontroller-based devices. Carefully chosen components and the use of machines of the last generation for mounting and testing thereof are the best guarantee of high reliability of our devices. Due to simple design, a large number of add-on modules and ready to use examples, all our users, regardless of their experience, have the possibility to develop their projects in a fast and efficient way.

Development System

 **MikroElektronika**

SOFTWARE AND HARDWARE SOLUTIONS FOR EMBEDDED WORLD ...making it simple

StartUSB for PIC

The StartUSB for PIC is a miniature development system that enables you to experiment with the PIC18F2550 microcontroller.

Key features:

- Bootloader;
- Proto board;
- USB support;
- 5V power supply voltage.

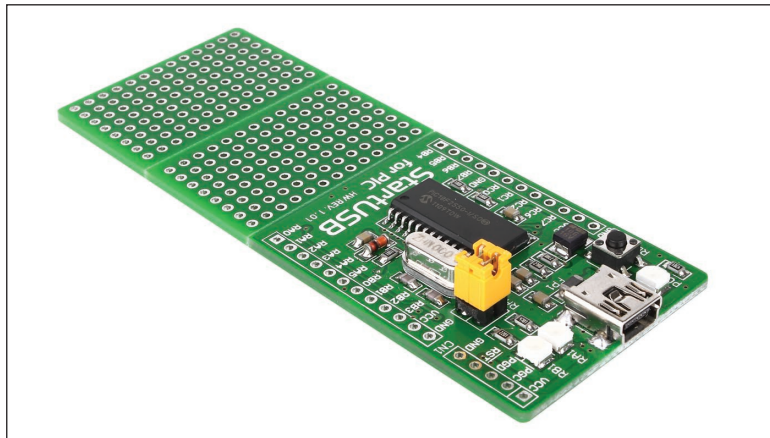

Figure 1: StartUSB for PIC development system

How to connect the development system?

The StartUSB for PIC development system can be easily connected to a PC via a USB connector CN2, Figure 3. The microcontroller pins can be connected to a device via 1x12 connectors CN3 and CN4. A 1x5 connector CN1 enables connection with the PICFlash programmer. An LED labelled POWER is used to indicate whether the board is turned on or off, whereas LEDs RA1 and RB1 can be configured to indicate the logic state on the RA1 and RB1 pins.

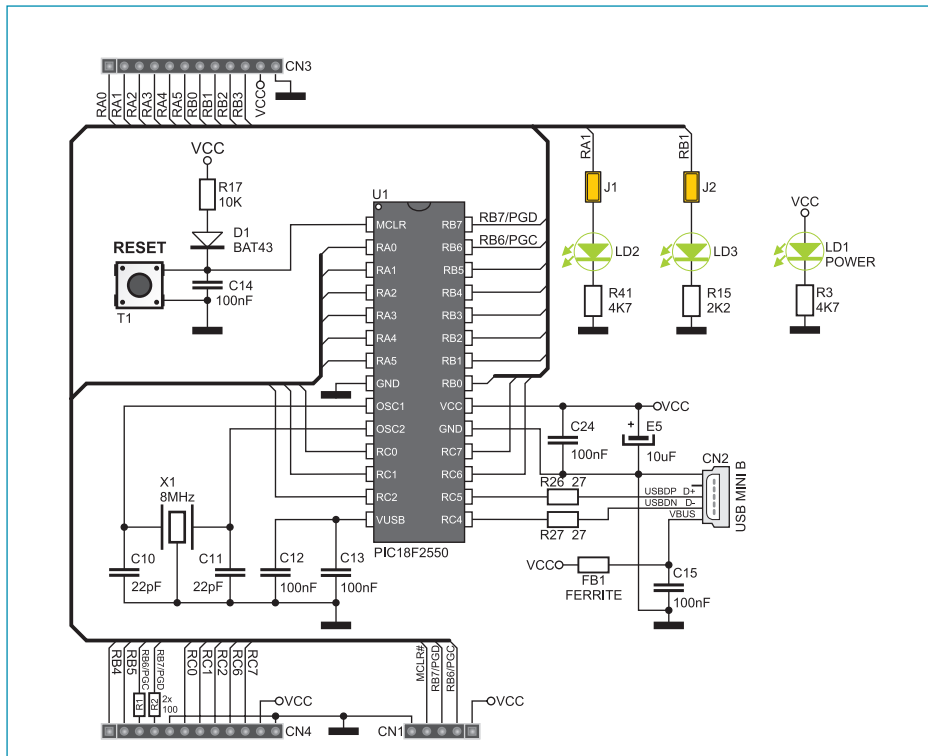

Figure 2: The StartUSB for PIC development system connection schematic

How to program the microcontroller?

.hex code is loaded into the microcontroller via the bootloader program stored in the microcontroller memory. The **mikroElektronika USB HID Bootloader** application is used to transfer the .hex code from the PC to the microcontroller.

Follow the steps below in order to program the microcontroller properly:

STEP 1: Connect the system to a PC

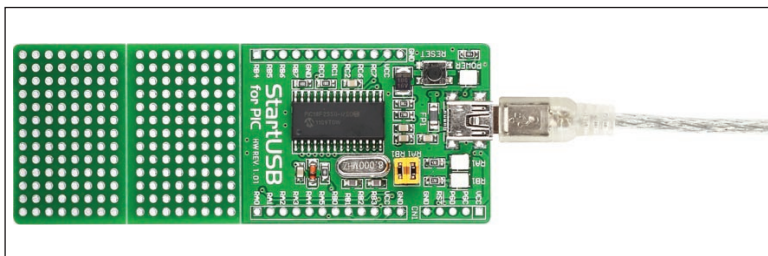

Figure 3: Connecting the system to a PC

STEP 2: Start up the mikroElektronika USB HID Bootloader application

Download the **mikroElektronika USB HID Bootloader** program from Mikroelektronika's website at : http://www.mikroe.com/eng/downloads/get/1570/mikrobootloader_usbhid_v100.zip

Unzip the file, then double click on the appropriate icon



STEP 3: Create a link between the microcontroller and the program

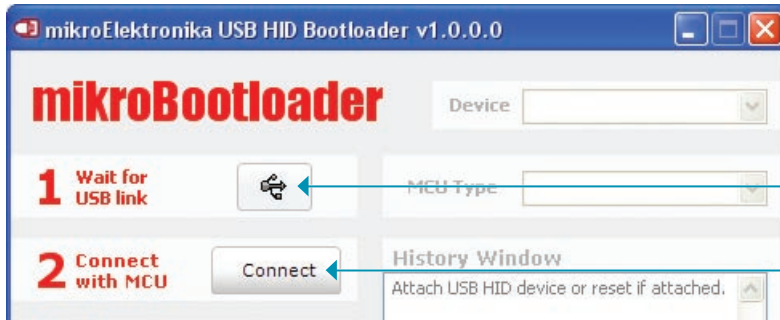

Reset the **StartUSB for PIC** system by pressing the RESET button.

Wait for the USB symbol to turn red

Click on the Connect button within 5s



The red color of the USB symbol indicates that the program is connected to the microcontroller

STEP 4: Browse for .hex file

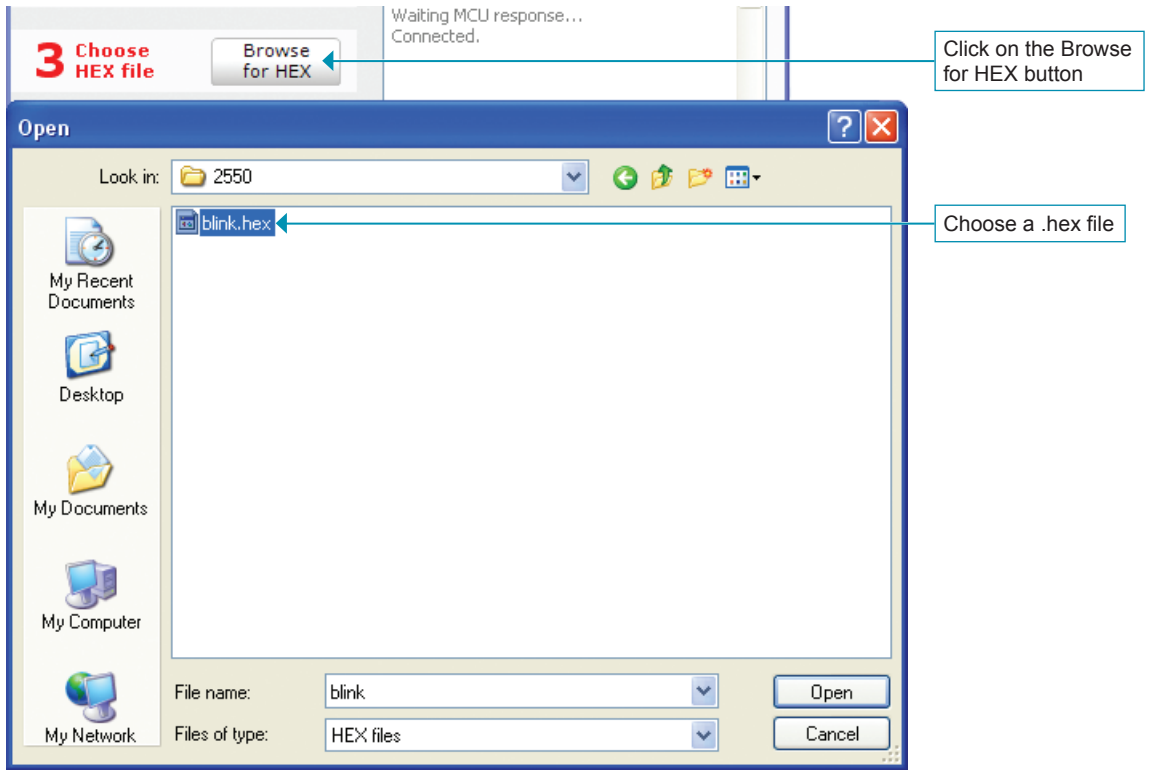

STEP 5: Upload the .hex file into the microcontroller

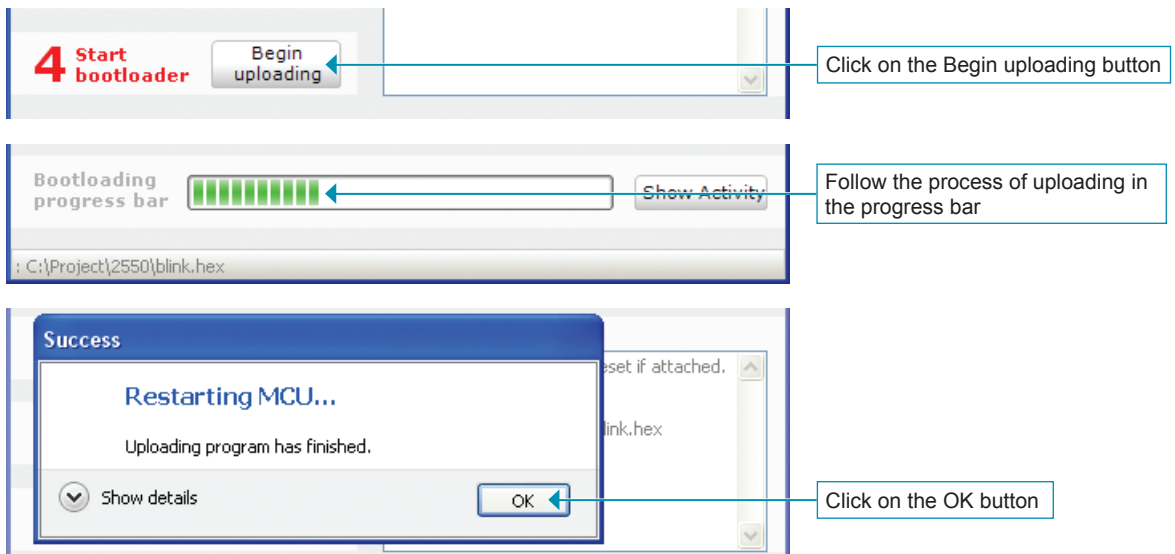

In addition to the programming via bootloader, the microcontroller can also be programmed with the PICFlash programmer, Figure 4. The bootloader program is automatically deleted during the process of programming the microcontroller with the PICFlash programmer. If you want to reload the bootloader program, you will find it in the same folder in which the **mikroElektronika USB HID Bootloader** program is stored.

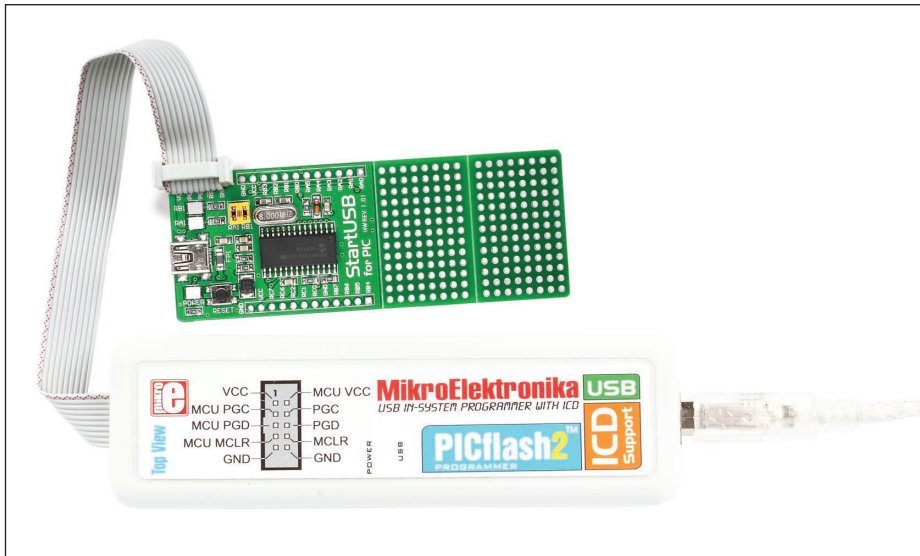

Figure 4: Programming with the PICFlash programmer

Find more information on the PICFlash programmer at:
<http://www.mikroe.com/eng/products/view/18/picflash-with-mikroicd-support/>

