

MP3 click™

1. Introduction

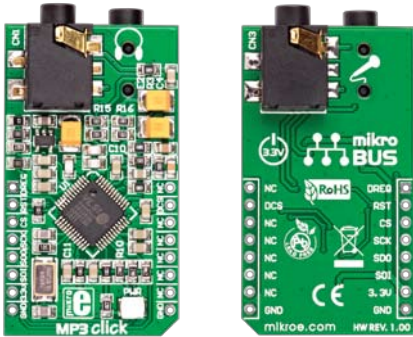

MP3 Click is an accessory board in **mikroBus™** form factor. It includes a stereo MP3 decoder chip **VS1053** which can decode multiple formats (Ogg vorbis, MP3, MP1, MP2, MPEG4, WMA, FLAC, WAW, MIDI), and encode three different formats from microphone in mono or stereo format (Ogg vorbis, IMA ADPCM, 16-bit PCM). Board uses industry-standard Serial Peripheral Interface for communication, and can only use **3.3V** power supply. Board features stereo headphone and microphone audio connectors.

2. Soldering the headers

Before using your click board, make sure to solder the provided 1x8 male headers to both sides of the board. Two 1x8 male headers are included with the board in the package.



2

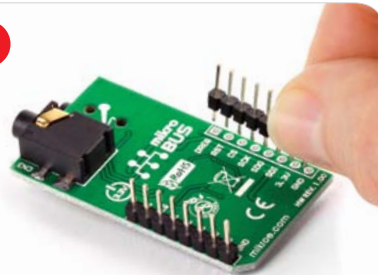

Turn the board upside down, so that bottom side is facing you upwards. Place shorter parts of the header pins in the both soldering pad locations.

3

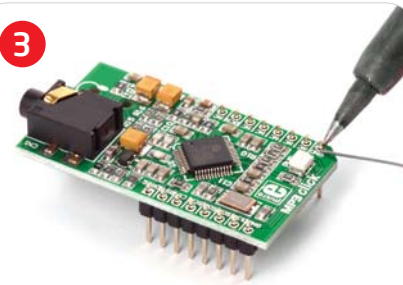

Turn the board upward again. Make sure to align the headers so that they are perpendicular to the board, then solder the pins carefully.

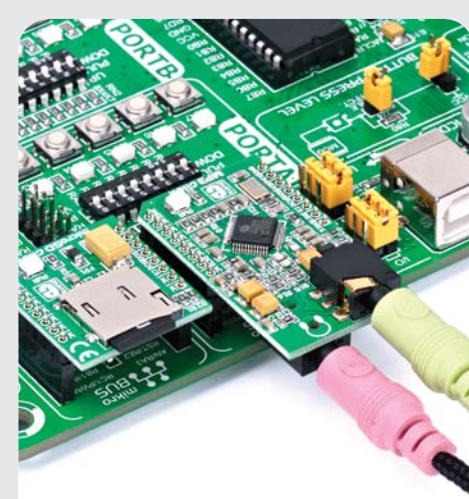

4. How to play music?

Using MP3 click in combination with mikroBUS click board, you can play music files directly from your microSD card. You can easily implement microcontroller software which can read mp3 files chunk-by-chunk, and send each chunk for decoding over the same SPI communication lines, with different chip selects for each board.

3. Plugging the board in

Once you have soldered the headers your board is ready to be placed into desired mikroBUS™ socket. Make sure to align the cut in the lower-right part of the board with the markings on the silkscreen at the mikroBUS™ socket. If all the pins are aligned correctly, push the board all the way into the socket.

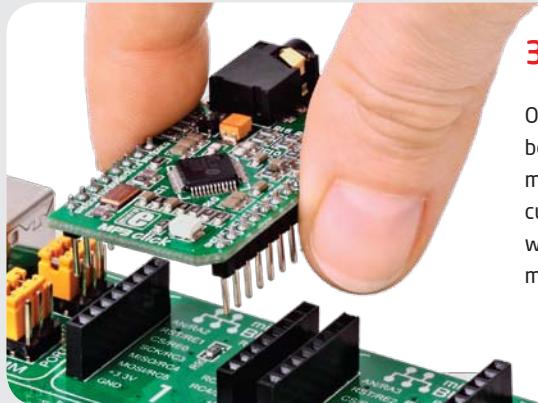

click™
BOARD
www.mikroe.com



MP3 click Manual
ver. 1.00



5. MP3 click Board Schematics

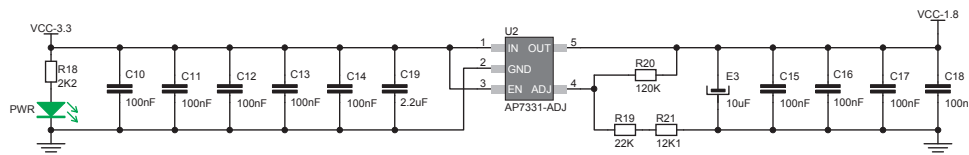
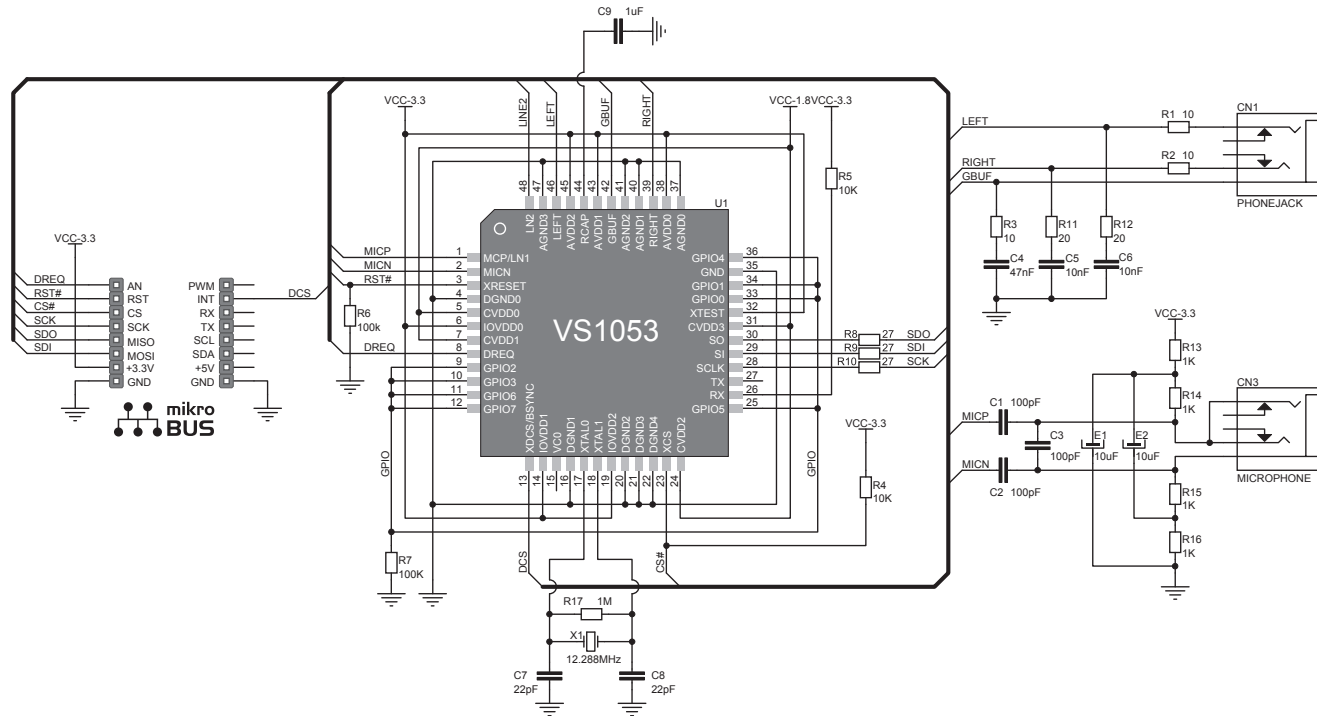

6. Power supply - 3.3V only



Board is designed to use 3.3V power supply only. If you need to add MP3 feature to your 5V prototype or development board, we recommend you to use other boards such as the SmartMP3 Accessory Board:

<http://www.mikroe.com/eng/products/view/165/smartmp3-board/>

7. Code Examples

Once you have done all the necessary preparations, it's time to get your click board up and running. We have provided the examples for mikroC, mikroBasic and mikroPascal compilers on our **Libstock** website. Just download them and you are ready to start.



8. Support

MikroElektronika offers **Free Tech Support** (www.mikroe.com/esupport) until the end of product lifetime, so if something goes wrong, we are ready and willing to help!

