

GET TO KNOW THE NXP ROBUST MPU PORTFOLIO, WITH SPOTLIGHTS ON i.MX 8ULP CROSSOVER APPLICATIONS PROCESSOR

Xinyu Chen
MAY 2023



SECURE CONNECTIONS
FOR A SMARTER WORLD

PUBLIC

NXP, THE NXP LOGO AND NXP SECURE CONNECTIONS FOR A SMARTER WORLD ARE TRADEMARKS OF NXP B.V.
ALL OTHER PRODUCT OR SERVICE NAMES ARE THE PROPERTY OF THEIR RESPECTIVE OWNERS. © 2023 NXP B.V.



ADVANCING EDGE PROCESSING FOR IoT

NXP unveils advanced i.MX applications processors with easy-to-deploy security and energy efficiency for the industrial and IoT Edge



EDGELOCK[®]
SECURE ENCLAVE

ENERGY FLEX
ARCHITECTURE

i.MX 8ULP FAMILY

i.MX 9 SERIES

i.MX 8ULP SOC

Very Low Power processing for use cases demanding a longer battery life

- FD-SOI 28nm Process Technology
- IP selection
- Heterogeneous architecture
- Low Power Mode enablement

Arm® CORTEX® - A35
Arm® CORTEX® - M33

ENTRY-LEVEL i.MX APPLICATIONS PROCESSORS FOR EDGE PROCESSING

NDA Required
Preliminary, Subject to Change

Compute Performance

- i.MX 8M NanoUL**
4xA53, M7, Camera
 - i.MX 7Dual**
2xA7, M4, 2xGbE, PCIe, Display/Camera
 - i.MX 7Solo**
A7, M4, GbE, Display/Camera, PCIe
 - i.MX 7ULP**
A7, M4, GPU, Display/Camera
 - i.MX 6UL**
A7, 2xEth, Automotive
 - i.MX 6ULL**
A7, 2xEth, Display/Camera
 - i.MX 6ULZ**
A7
- Production Now**

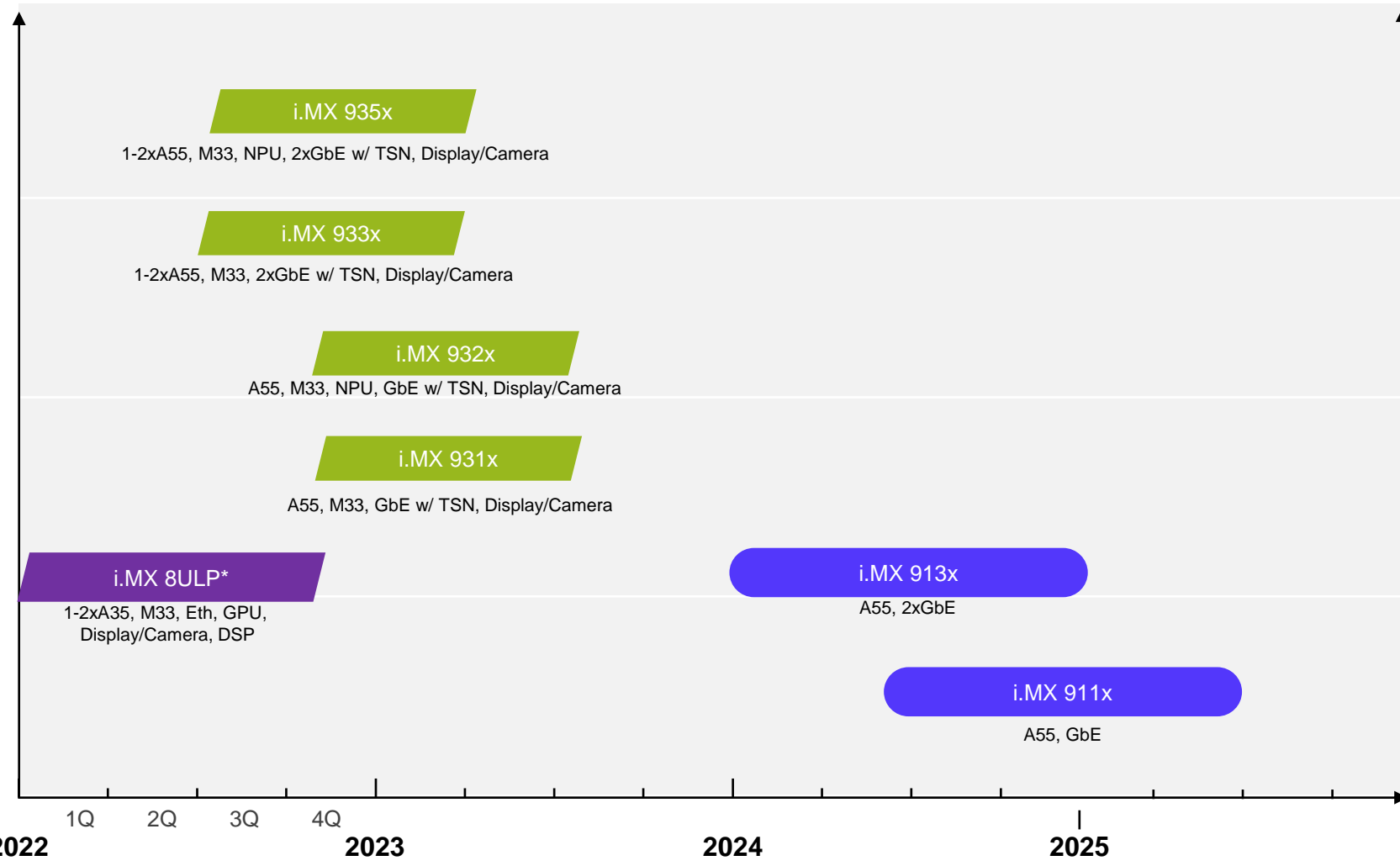

- Performance & Multimedia**
- Edge Aware**
- Energy Efficient States**
- Advanced Security**
- Scalable Platform**

NXP 15yr Product Longevity Program

* Alpha Sampling (now)

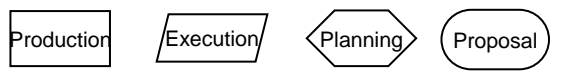

First Sample Date (left edge) Product Qualification (right edge)

PUBLIC

4



i.MX SERIES OF APPLICATIONS PROCESSORS

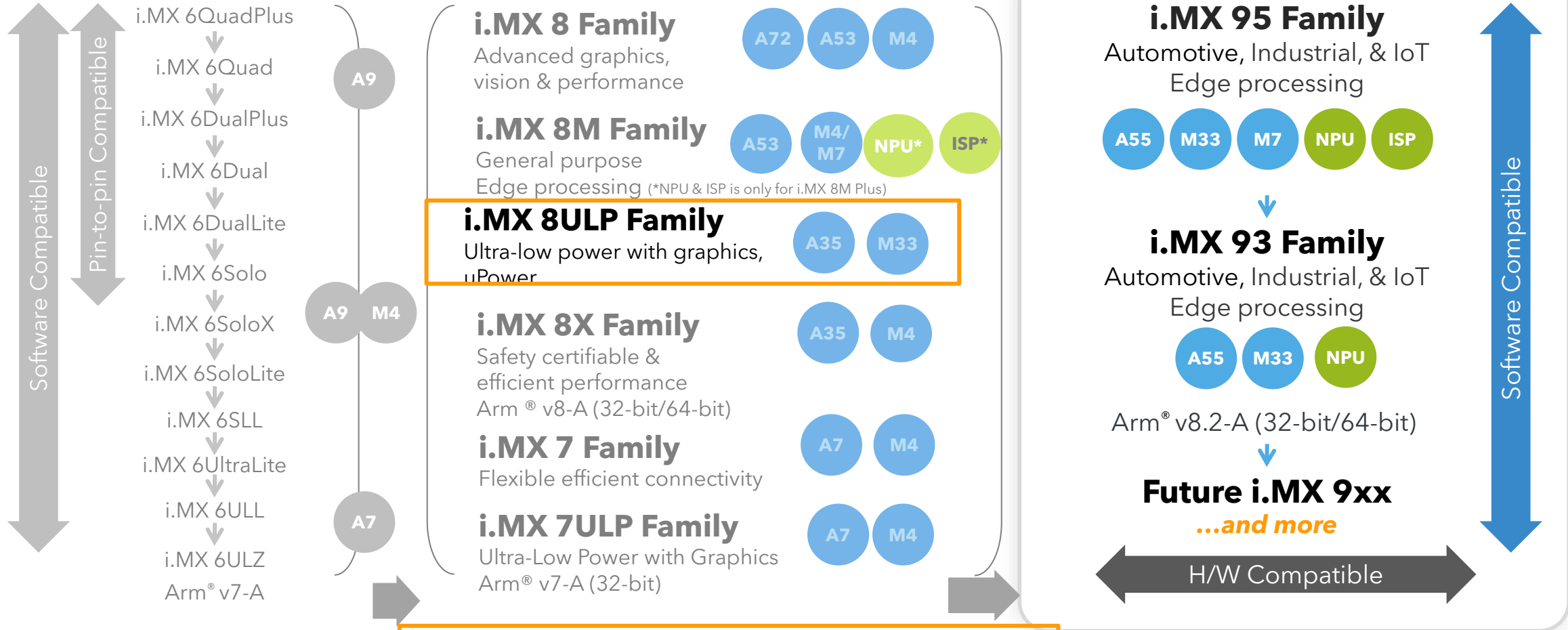

- Power Efficiency, First & Foremost (RVT v. LVT)
- Always choosing Low Power Connectivity
- Seeking Lowest Leakage Architecture and Technology

LEVERAGING MPU, MCU, DSP IN ONE DEVICE AND ADDING MORE FLEXIBILITY

- Each domain can be independently powered off, so that it only consumes power when needed:
 - **Application Domain** contains main high-performance application cores. Includes fine-grained control of number and operating frequency.
 - **Flex Domain** includes multimedia and neural processing accelerators
 - **Real Time Domain** includes low-power real-time core and peripherals to enable background processes such as wake-word detect to consume very little power.
 - **Peripheral Access** to any peripheral by any domain is allowed through eXtended Resource Domain Control (XRDC)
 - **Secure Communication** between domains is enabled by secure Messaging Units (MUs)

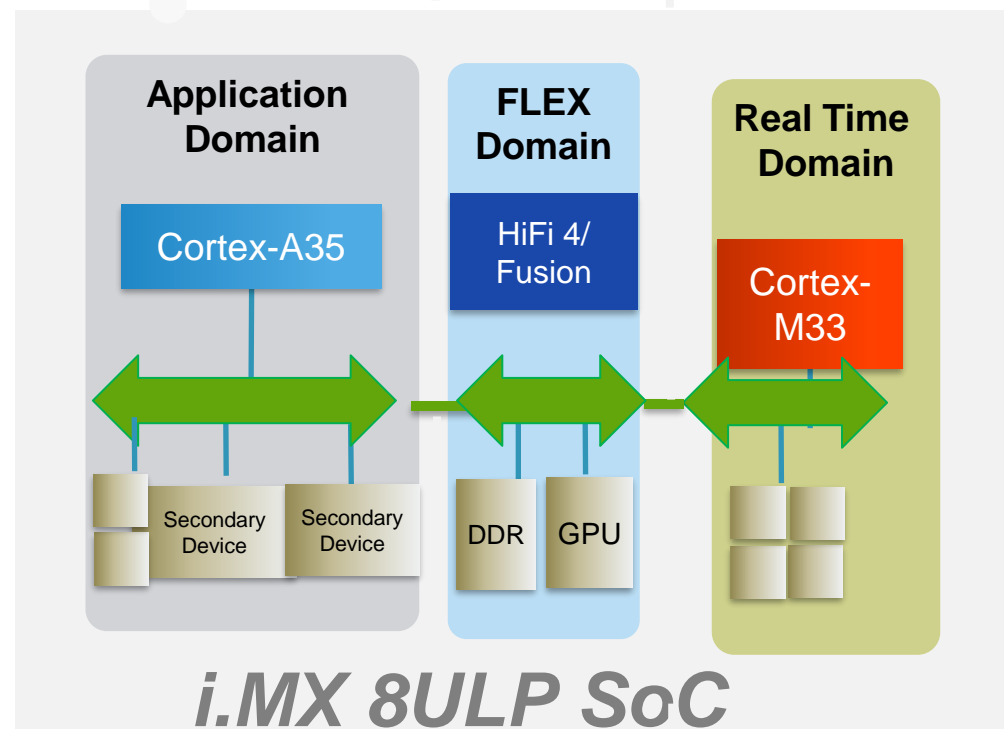

- High Core Processing Performance
- Rich OS support
- NEON Acceleration
- High Bandwidth
- MMU
- H/W MACs
- Support for emerging multi-channel object-based audio standards
- FIR, FFT, IIR acceleration
- Real Time Performance
- Right Sized Processing
- Extreme Low Power Modes

HETEROGENEOUS DOMAIN COMPUTING (HDC)

Shared Topology Split Power Domains... Split Buses...

i.MX 8ULP SOC



APPLICATION DOMAIN

REAL TIME DOMAIN

Arm Processor

On-chip Memory

Ext Mem Support

Security

	Application processor domain	Real-time processor domain
Arm Processor	Dual core Cortex®-A35 Frequency up to 900MHz*	Cortex®-M33F Nominal (RUN) frequency: 216 MHz
On-chip Memory	32 KB instruction and 32 KB data cache	32 KB instruction and 32 KB data cache
Ext Mem Support	Floating Point Unit (FPU) 512 KB of L2 cache with Snoop Control Unit (SCU)	Floating Point Unit (FPU) Memory Protection Unit (MPU)
Security	NEON™ SIMD engine	Co-processor interface for • PowerQuad hardware accelerator (Fixed and floating point +FFT) DSP functions • CASPER Crypto/FFT engine
	—	Tensilica DSP Fusion F1 DSP processor Nominal frequency: 200 MHz
	32 channel DMA	32 channel DMA
	64 KB of RAM	768 KB of Shared Memory, zero wait state
	192 KB of Boot ROM	96 KB of Boot ROM
	FlexSPI Serial flash interface to quad/octalSPI flash device	Dual FlexSPI Serial flash interface to quad/octalSPI flash device
	3 eMMC/SD host interfaces supporting eMMC5.1 and SD3.0	—
	Cryptographic acceleration supporting • symmetric and asymmetric ciphering algorithms • SHA-256 hashing algorithm	EdgeLock secure enclave (ELka) as Root of Trust (RoT) • Core supporting up-to 216 MHz • Dedicated boot ROM with Advanced High Assurance boot(AHAB) • ECDSA P256 based signature verification • Support for symmetric Cryptographic acceleration (SGI) • Support for Asymmetric Cryptographic acceleration (PKC) • NIST compliant RNG with DRBG • PLF(Physically Unclonable Function) based Root Keys as option • One-Time Programmable electrical fuse used for security keys
	NIST-approved random number generator	On-The-Fly decryption of the encrypted code stored in external flash device
	32 KB secure RAM	—

DDR/GPU/DISPLAY/CAMERA/AUDIO

External memory interfaces	LPDDR3, LPDDR4, LPDDR4x
Graphics, display and Camera Interface	GPU3D • Support for Open GL ES 3.1, Vulkan 1.1, Open CL 2.x and Open VG1.1 GPU2D Composition Processing Core (CPC) GPU 4-lane MIPI DSI interface Dual lane MIPI CSI interface Image Sensing interface (ISI) with one pixel link interface PXP E-Ink Display Engine Display controller (DCNano) that supports EPDC panels through MIPI, Smart Displays and Video mode Can be optionally powered off when not in use
Audio peripherals	2 I2S ports

Application processor domain	Real-time processor domain
1x Watchdog (WDOG) timer	
Low Power Implementation	
uPower Sub-system for advanced Power measurement ¹ and control functionality	
<ul style="list-style-type: none"> RISC-V ISA compliant CPU core Dedicated code and data RAM Critical path and process monitors to provide device parameters Supports fully automated DVFS (Dynamic Voltage and Frequency Scaling) 	
Multiple power domains and ultra-low power modes allow flexible power saving	
HiFi4 DSP can be power gated while keeping DSP domain operational for Voice trigger	

BRINGING TOGETHER APPLICATIONS PROCESSOR PERFORMANCE AND MCU LOW POWER WITH DSP EFFICIENCY



Rich 3D and 2D Graphics

- **GC7000 nanoULTRA**
 - OpenGL ES 2.0/1.1
 - OpenVG 1.1
- **GC320 2D Composition**
 - Offloads tasks from 3D GPU
 - Stretch/Shrinking, rotation, GUI processing

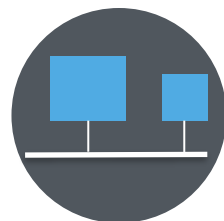

Heterogeneous Computing

- **Multiple software execution:**
 - Powerful processing using **Arm® Cortex®-A35** and
 - Real-time perf with Cortex-M33
 - **Dual DSP enablement**
 - **Hif4** – High performance
 - **Fusion** – low power
- **System integrity and security**
 - Resource Domain Controller
 - Fast Low Power Boot
 - Safe Recovery of Application domain



Power Efficiency

- **FDSOI**
 - Effective control of the transistor channel through biasing
- **High Performance/mW** extending battery life for portable devices.
- **Performance on Demand** with fast wake up times

i.MX 8ULP SOC FEATURES AND USE CASES

	i.MX 8ULP*	Description	Examples
Main CPU	1x/2xArm® Cortex®-A35 at 800Mhz* (max 900MHz (DVS, OD)	A35 core with several modes (with active biasing offered by the FDSOI technology)	Under Drive with Forward bias is suited for ultra low power
MCU	Arm Cortex-M33 @ 216MHz HiFi4/Fusion DSP	Wake from reset possible from M33 , Voice recognition Deep sleep power is 200uW	Lowest power of all the products for wake word detection RTD mode can be in deep sleep
DDR	32-bit LPDDR3/LPDDR4/LPDDR4X, 1.056 GT/s	DDR control possible from LPAV or RTD	This allows a low power mode refresh, which is unique to the ULP family
GPU	3D GPU includes Open GL® ES 3.1, OpenCL™, Vulkan® 2D GPU	High performance Graphics, while maintaining low power	Advanced 3D graphics with 2D accelerator
Security	Edge Lock Secure Enclave	The standard security features but with advanced separation of each domain (for low power wake, deep sleep)	Application Security Features Crypto Key storage with Fine Grain Policies Cryptography with Countermeasures Updateable/Customizable
AI/ML	A35		
Vision/Camera	1x MIPI CSI (2-lane) with PHY	Camera Interface	Suitable for handheld scanners, low power wake , fast wake time
Display	1x MIPI DSI (4-lane) with PHY Up-to 24-bit RGB /DPI)	EPDC , e-Ink Display	Supports displays that are critical for wearables, medical devices, e-readers while maintaining low power modes
Video Encode	No HW VPU	-	-
Audio	6x I2S TDM, ASRC, 8ch PDM DMIC input), S/PDIF Tx+Rx	Low power enablement	Very low power wake word
High-Speed I/O	2x USB 2.0 10/100 Ethernet3x SD/eMMC, OctalSPI	IO pins & HS interface	Sufficient for communication with an NXP Wi-Fi SOC such as IW416

Notes: A35 Fmax, DVS , OD_{AFBB}. DVS will be available after launch.

NXP SOC SCALABLE SECURITY ARCHITECTURE

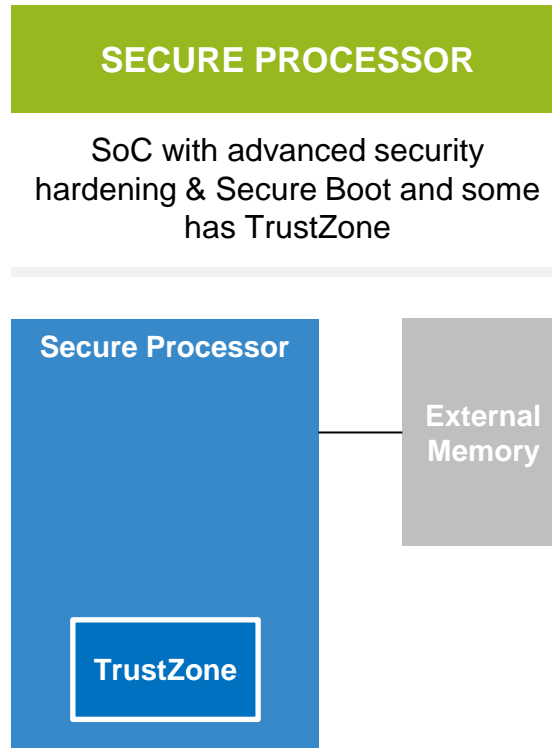
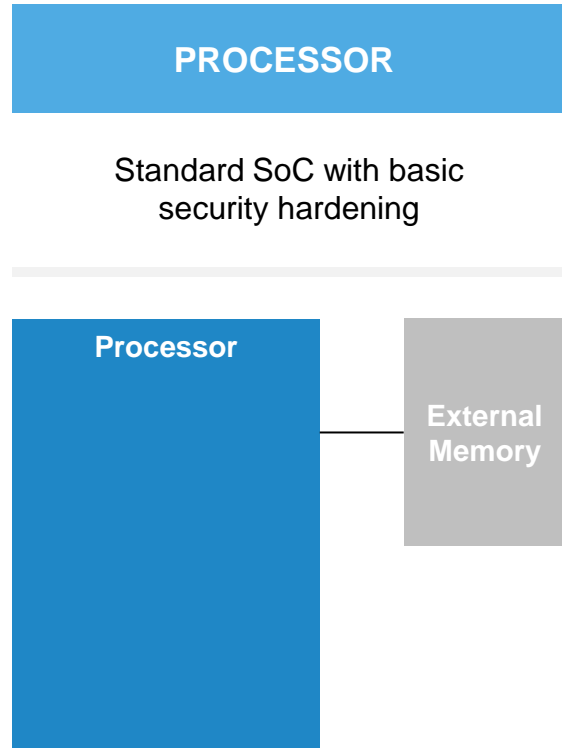

i.MX RT1170

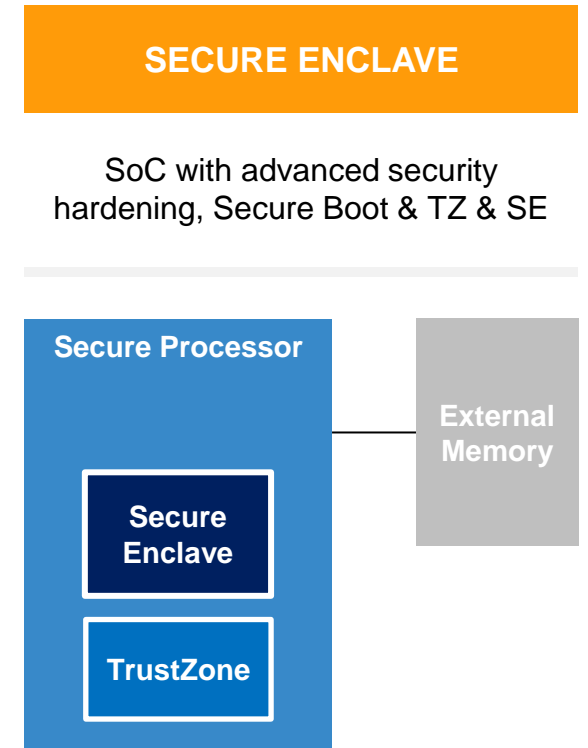

i.MX 8ULP

LINUX® POWER NUMBERS: FEBRUARY 2023, HIGHLIGHTS

NDA Required
Preliminary, Subject to Change

Power_AN_Casename	Description	Measured #s (mW)	Application/customer use-case
Suspend Mode			APD in Power Down mode (Linux enter suspend),LPAV in Power Down mode with DDR in self-refresh mode, RTD in various low power modes. Smart watch, wearables, portables, eReader, Gateway, sensor hub, Low power voice, wake word, HMI – low power modes are applicable to all system use-cases.
Suspend Mode – RTD power down	Suspend to RAM_DSM	1	
Suspend Mode – RTD active	Suspend Mode RTD active	54	
Suspend Mode – RTD sleep	Suspend Mode RTD sleep	46	
Suspend Mode – RTD deep sleep	Suspend Mode RTD deep sleep	46	
System Idle			Modes with fast wake up from Idle mode
System Idle with screen on	User idle screen on	433	HMI
System Idle with screen off	IDLE_DDRC_25MHz	244	HMI
Core			
Coremark (Arm recommends Coremark over Dhrystone)	Coremark	534	Coremark – multithread set to 2. Reference for use-cases with full CPU loading.
core Dhryst + MM07 + HIFI4 + M33 coremark (heavy load)	dhry_hifi_mm07_m33coremark	772	Heavy load system use-case for reference – Loading A35, M33, GPU3D and HiFi4.
GPU			
GPU 2D + GPU 3D + CSI/DSI	gpu2d_gpu3d_csi	723	Heavy load use-case for reference – simple use-case without heavy loading would be HMI
Wake Word			
Audio			
Audio Playback		424	Bluetooth speaker, HMI with audio playback. The A35 handles the mp3 audio decoding, and M33 handles the PCM playback through I2S.
Display			
Parallel Eink Page Flip	Parallel Eink Page Flip	480	eBook or eReader use-case; EPDC connected to a parallel BB3300-FOC Eink panel
Always-on Display, 1fps fresh rate	APD in suspend mode, M33 updating display every second.	93	Smart appliance, HMI, portables, wearables

i.MX 8ULP SOC SCHEDULE OVERVIEW

2022

A1 Pre-production

2023

2024

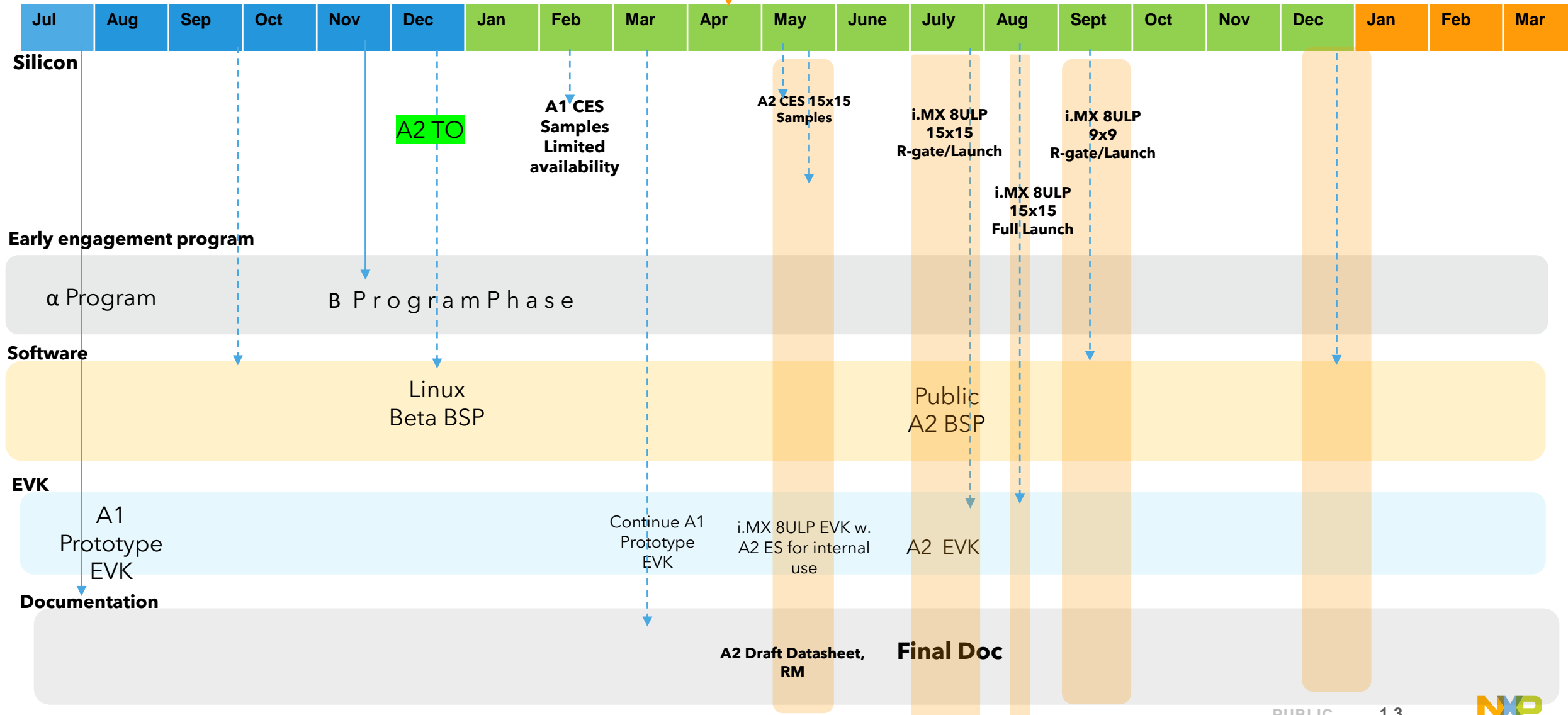

SCHEDULE

Silicon

- A2 Silicon tape-out: Dec 2022 (Done)
- A1 CES (additional) & EVKs: Available now
- A2 Silicon received: Feb 6 , 2023 (Done)
- A2 Early samples: April 2023 (In progress)
- A2 CES (15x15) : May 2023
- A2 R-Gate (15x15): Q2 2023

LAUNCH 15x15 July 2023 (e-commerce active, parts orderable via nxp.com)

Full Market Launch: Aug 15, 2023 (full availability)

A2 CES (9.4x9.4): Early June 2023

- A2 R-Gate (9.4x9.4): August 2023

Full Market launch 9.4x9.4 September 2023 (full availability)

EVKs

Currently : limited A1 CES based EVK

May 2023 : limited availability with A2 CES

July 2023 : Full availability

BSP/SDK (see next slide)

LINUX® BSP ROADMAP

2023

2024

2025

Q1 Q2 Q3 Q4 Q1 Q2 Q3 Q4 Q1

New kernel upgrade LTS Upstream New kernel upgrade LTS Upstream New kernel upgrade

Linux LTS Quarterly Release (Yocto)

L6.1.1_1.0.0 L6.1.y_2.0.0 L6.1.y_2.1.0 L6.1.y_2.2.0 L6.x.y_1.0.0 L6.x.y_2.0.0 L6.x.y_2.1.0 L6.x.y_2.2.0

Supported Platforms

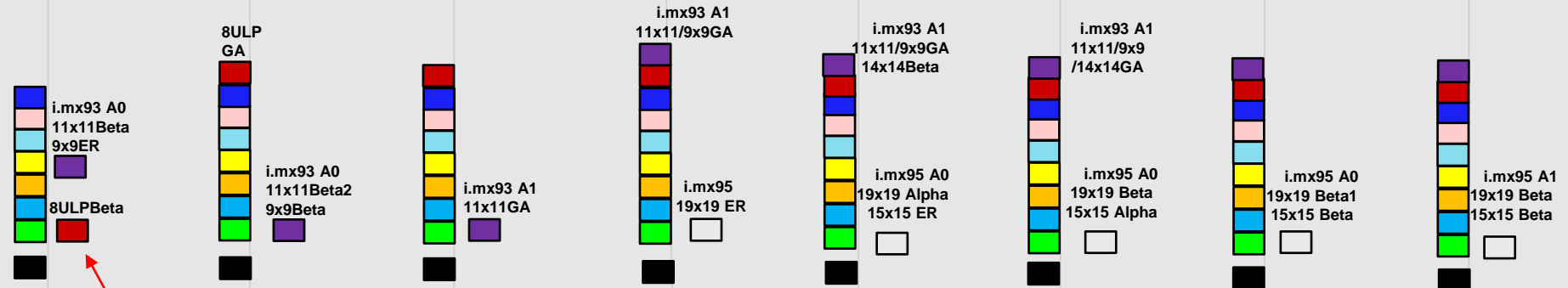

Release	Internal Release Date	External Release Date
LF6.1.1_2.0.0/SDK2.13 (Yocto 4.2)	Jun 23 2023	Jun 30 2023
Android-13.0.0_2.0.0 (L6.1.1)	Jul 24 2023	Jul 31 2023

Legend

- i.MX 8M Nano
- i.MX 8QuadMax, i.MX 8QuadPlus
- i.MX 8DualXLite
- Layerscape platforms
- i.MX 8QuadXPlus
- i.MX 8M Plus
- i.MX 8ULP
- Shipping (i.MX 8M Quad, and i.MX 8M Mini)
- i.MX 93
- i.MX 95
- Shipping i.MX 6 and i.MX 7



i.MX SERIES ANDROID RELEASES 2023

Android 13/14

Features	Android-13.0.0-1.2.0	Android-13.0.0-2.0.0	Android-13.0.0-2.2.0	Android-14.0.0-1.0.0
Release	Q1 2023	Q2 2023	Q3 2023	Q4 2023
Android	13.0	13.0	13.0	14.0
Kernel	5.15	6.1	6.1	6.1
U-Boot	2022.04	2023.04	2023.04	2023.04
Graphics	6.4.3P4.0	6.4.11	6.4.11	6.4.11
Display	MIPI, HDMI, LVDS	MIPI, HDMI, LVDS	MIPI, HDMI, LVDS	MIPI, HDMI, LVDS
Audio	ESAI	ESAI	ESAI	ESAI
Silicon not supported	i.MX 6 Series i.MX 7 Series	i.MX 6 Series i.MX 7 Series	i.MX 6 Series i.MX 7 Series	i.MX 6 Series i.MX 7 Series
Supported Silicon	.iMX 8QuadMax i.MX 8QuadXPlus i.MX 8M Quad i.MX 8M Mini i.MX 8M Nano i.MX 8M Plus i.MX 8ULP	.iMX 8QuadMax i.MX 8QuadXPlus i.MX 8M Quad i.MX 8M Mini i.MX 8M Nano i.MX 8M Plus i.MX 8ULP	.iMX 8QuadMax i.MX 8QuadXPlus i.MX 8M Quad i.MX 8M Mini i.MX 8M Nano i.MX 8M Plus i.MX 8ULP	.iMX 8QuadMax i.MX 8QuadXPlus i.MX 8M Quad i.MX 8M Mini i.MX 8M Nano i.MX 8M Plus i.MX 8ULP i.MX95

i.MX 8ULP TARGET APPLICATIONS

Industrial/Energy	Consumer	IoT
<p>Lab electronics</p> <p>Medical electronics</p> <p>EV Chargers</p> <p>Base station</p> <p>Transportation</p> <p>HMI</p> <p>Energy metering</p>	<p>Consumer wearables</p> <p>eReaders</p> <p>2-way Radio</p> <p>Weighing scales</p> <p>Bike Computers</p>	<p>RF ID readers</p> <p>Printers</p> <p>Handheld Scanners</p> <p>Voice enabled devices</p> <p>NFC PoS attach</p>



AVAILABLE PART NUMBERS (PRODUCTION*) : FULLY ORDERABLE JUNE 2023

PART NUMBERS OFFERED (MIMX8UxxDxxxxxx)=Consumer (MIMX8UxxCxxxxxx)=Industrial	PKG	CPUs (A-35/M33/HiFi4/DSP)	Display/Camera	Network & Connectivity	Audio
MIMX8UD7DVP08SC	15x15	2xA35 , M33,HiFi4/DSP ,3D GPU , EPDC	1. 4-lane 1x MIPI DSI with PHY Up-to 24-bit RGB /DPI) EPDC & e-Ink support 2. 1 MIPI CS1	2x USB 2.0 10/100 Ethernet 3x SD/eMMC, Octal SPI	6x I2S TDM, ASRC, 8ch PDM DMIC input), S/PDIF Tx+Rx
MIMX8UD5DVP08SC		2xA35 , M33,HiFi4/DSP ,3D GPU			
MIMX8UD3DVP08SC		2xA35 , M33			
MIMX8UD7CVP08SC		2xA35 , M33,HiFi4/DSP ,3D GPU , EPDC			
MIMX8US3DVP08SC		1x A35 , M33			
MIMX8US5DVP08SC		1x A35 , M33,HiFi4/DSP ,3D GPU			
MIMX8UD3CVP08SC		2xA35 , M33			
MIMX8UD5CVP08SC		2xA35 , M33,HiFi4/DSP ,3D GPU			
MIMX8US5CVP08SC		1x A35 , M33,HiFi4/DSP ,3D GPU			
MIMX8US3CVP08SC		1x A35, M33			
MIMX8US5DVK08SC	9.4x9.4	1x A35, M33,HiFi4/DSP ,3D GPU	1. 2-lane 1x MIPI DSI with PHY Up-to 24-bit RGB /DPI) EPDC & e-Ink support 2. 1 MIPI CS1		
MIMX8US3DVK08SC		1x A35, M33 (consumer)			
MIMX8UD5CVK08SC		2xA35 , M33,HiFi4/DSP ,3D GPU			
MIMX8UD5DVK08SC		2xA35 , M33,HiFi4/DSP ,3D GPU			
MIMX8UD7DVK08SC		2xA35 , M33,HiFi4/DSP ,3D GPU , EPDC			

A2 (production) SAMPLES orderable now! AVAILABLE end of May 2023!

PIMX8UD7CVP08SC (15x15)

PIMX8UD5DVK08SC (9x9)

i.MX 8ULP VS. i.MX 932/1/0X COMPARISON

	i.MX 930x	i.MX 932x/1x *	i.MX 8ULP*	Low power & feature highlights of 8ULP
Main CPU	1x/2x A55 900MHz Arm v8.2-A	1x/2x A55 900MHz Arm v8.2-A	1x/2xArm® Cortex®-A35 at 800Mhz	Low power deep sleep with DDR self-refresh
MCU	1x M33 @ 250MHz	1x M33 @ 250MHz	Arm Cortex-M33 @ 216MHz HiFi4/Fusion DSP (enables ML)	Lowest wake time and optimized voice wake word power
DDR	1.6 GT/s x16 LPDDR4/4X	1.6 GT/s x16 LPDDR4/4X	1.06GT/s LPDDR3/LPDDR4/LPDDR4X	DDR self-refresh
GPU	2D: PXP	2D: PXP	•3D GPU includes Open GL® ES 3.1, OpenCL™, Vulkan® •2D GPU *rich graphics	Advanced Graphics
Security	Secure Enclave	Secure Enclave	Secure Enclave	Lowest power entry /exit/ during reset/boot with security enabled
Vision	No ISP	No ISP	No ISP	n/a
Display	1080p60 MIPI DSI (4-lane) or 720p60 LVDS (4-lane) or 18-bit parallel RGB	None	1080p60fps 4-lane MIPI DSI (4-lane) with PHY Up-to 24-bit RGB /DPI)	EPDC , e-Ink Display
Camera	MIPI-CS1 2-lane	None	MIPI CSI 2-lane	MIPI CSI 2-lane in all variants
Video Decode/Encode	No HW VPU	No HW VPU	No HW VPU	n/a-
Audio	3x I2S TDM, SPDIF Tx+Rx PDM mic, MQS	3x I2S TDM, SPDIF Tx+Rx PDM mic, MQS	6x I2S TDM, ASRC, 8ch PDM DMIC input), S/PDIF Tx+Rx	Lowest power Wake word
High-Speed I/O	1x USB 2.0 1x GbE (1 w/ TSN) 3x SD/eMMC <i>*comparable in pricing</i>	1x USB 2.0 1x GbE (1 w/ TSN) 3x SD/eMMC	2x USB2.0 10/100 Ethernet 3x SD/eMMC, OctalSPI	2x USB 2.0 in all versions

i.MX 8ULP FAMILY PART NUMBER DEFINITION

Preliminary

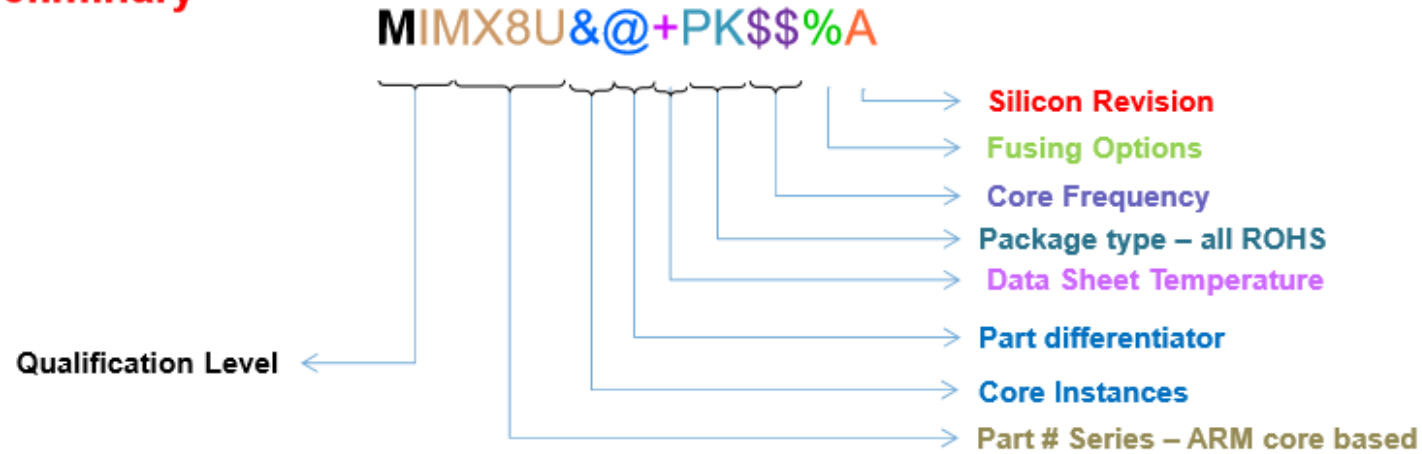

Qualification Level	MC
Samples	P
Mass Production	M
Special	S

Core instances	&
2 x Cortex-A35	D
1 x Cortex-A35	S

Temperature Tj	+
Consumer: 0 to +95C	D
Industrial: -40 to +105C	C

Frequency	\$\$
700 MHz	07
800 MHz	08
1GHz	10

700M, 1G will not be offered

Part # Series	
IMX8U	i.MX 8ULP
IMX8L	i.XM 8ULP Lite: 384KB RTD SRAM

Part differentiator	@
Full Featured	7
No DSPs	6
No EPDC	5
No GPU, No EPDC, no Hifi4	3

Package Type	PK
MAPBGA 15x15 0.5mm	VP
MAPBGA 9.4 x9.4.5mm	VK

Fusing	%
NXP Secure Enclave Enabled	S
Pluton enabled secure enclave	A

A needs to be removed

Silicon Rev	A
Rev A0	A
Rev A1	B

Rev A2 = C

8L will not be offered, but we will provide an app note if lower RTD SRAM is desired



ACCESSORIES – MIPI-DSI PANEL, E-PANEL (RENAMED) , MIPI-CSI SUPPORT

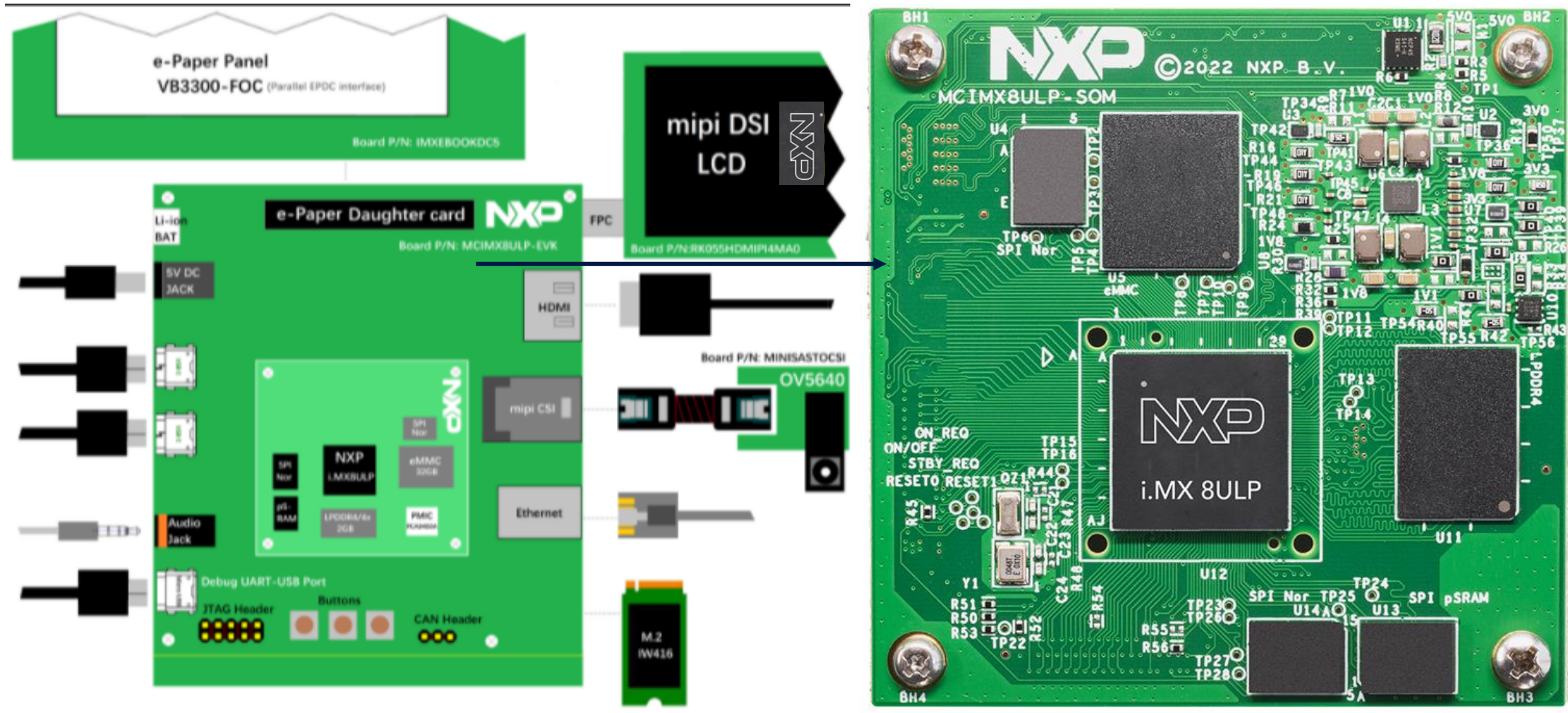

display P/N : VB3300- FOC , panel P/N in NXP :IMXEBOOKDC
Camera : MINISASTOCSI /OV5640

i.MX 8ULP EVK

- Part # : MCIMX8ULP-EVK
- Enables fast use case evaluation through quick builds of dips customized base boards.
- Allows customers to leverage the critical features of SOM design including DDR and PMIC design/layout.
- M.2 Wi-Fi module included
- Arduino expansion socket
- Design Files provided
 - Schematics
 - Layout
 - BOM



FRONT AND BACK

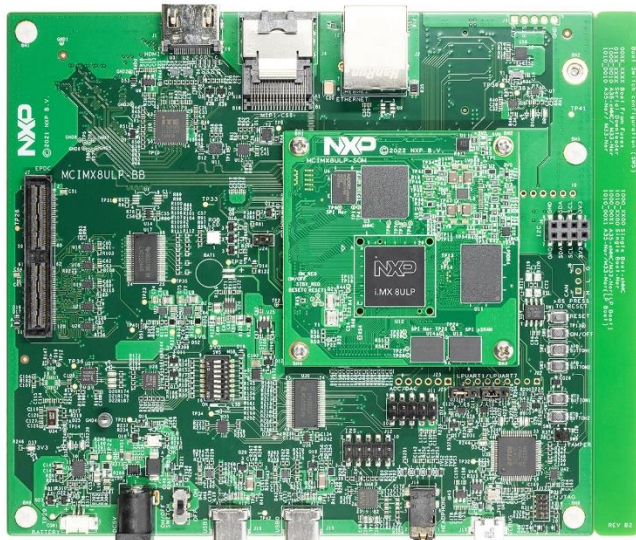

FRONT

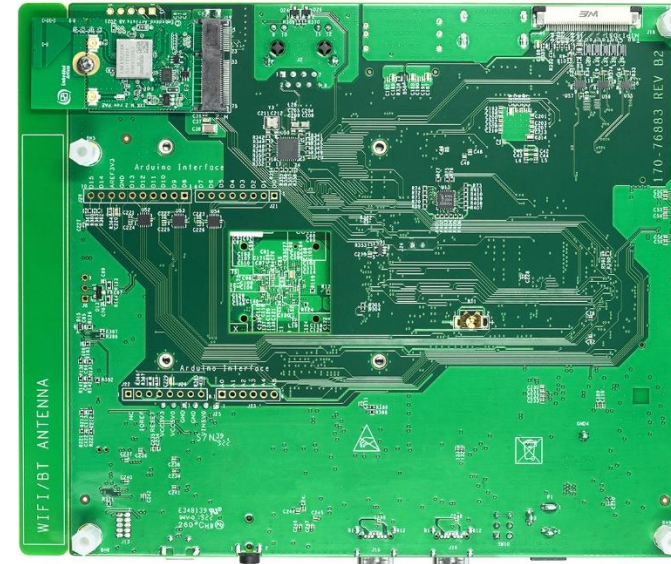

BACK



- Display panel P/N in NXP :IMXEBOOKDC
- Camera : MINISASTOCSI /OV5640

GENERIC E-READER BLOCK DIAGRAM

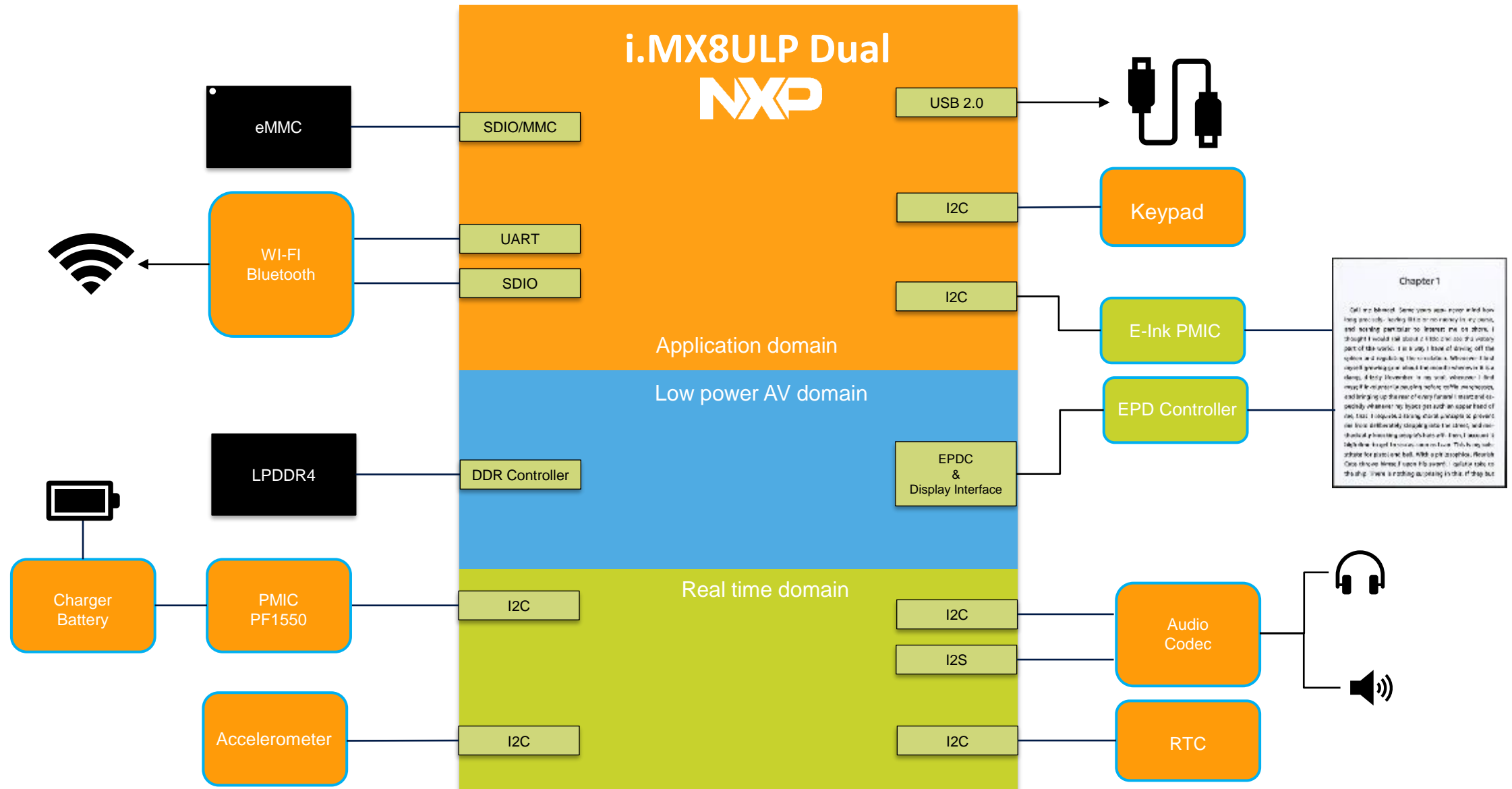

EBS Partners



SECURE CONNECTIONS
FOR A SMARTER WORLD

PUBLIC

NXP, THE NXP LOGO AND NXP SECURE CONNECTIONS FOR A SMARTER WORLD ARE TRADEMARKS OF NXP B.V.
ALL OTHER PRODUCT OR SERVICE NAMES ARE THE PROPERTY OF THEIR RESPECTIVE OWNERS. © 2023 NXP B.V.



PARTNERS



Note: Press "Control" and click on image

Power Management IC



SECURE CONNECTIONS
FOR A SMARTER WORLD





PUBLIC

NXP, THE NXP LOGO AND NXP SECURE CONNECTIONS FOR A SMARTER WORLD ARE TRADEMARKS OF NXP B.V.
ALL OTHER PRODUCT OR SERVICE NAMES ARE THE PROPERTY OF THEIR RESPECTIVE OWNERS. © 2023 NXP B.V.

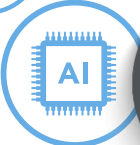
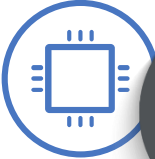

POWER MANAGEMENT SOLUTIONS FOR NXP MCUS, MPUS, AND CROSSOVER DEVICES

REDUCED SOLUTION SIZE
INCREASED PERFORMANCE
QUICK TIME TO MARKET

-   **Industrial Temp Rated and Longevity Matched**
 - Industrial and Auto Temperature Rated
 - Longevity matched between Processor and Power
-  **Packages to Suit Application**
 - Low profile CSP
 - Robust QFN and BGA
 - Automotive friendly packages
-   **Power for the Whole System**
 - Multiple Rails To Support System Requirements
 - Scalable solutions using VR+ PMIC
-   **Battery Management**
 - Battery Charger and gauging functionality
 - Small solution size and high eff/Low Iq

CO-DESIGNED

Co-designed keeping the end application in mind unlocking the performance

VALIDATED

Thoroughly validated together and supported by NXP throughout the customer lifecycle

SYSTEM LEVEL SUPPORT

Often include system-level power support such as battery management, safety rating

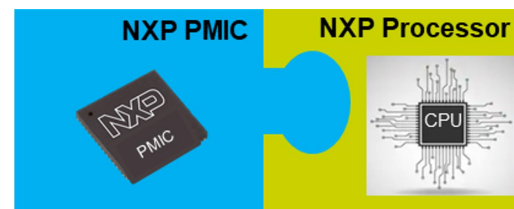

PCA9460 PMIC (FOR I.MX 8ULP PROCESSOR)

Features List:

- **Four low Iq buck regulators**
 - 2 x 1 A buck regulators supporting DVS
 - 2 x 1 A general purpose buck regulators
 - Quiescent current:
 - 1 μ A low power mode
 - 5 μ A in normal mode
 - Smart DVS control
- **Five low Iq LDOs**
 - 1x 10 mA LDO
 - 4x 250 mA LDOs
 - 0.5 μ A quiescent current
- **Four load switches rated for**
 - 1.2 V ~ 5.5 V
 - 100 m Ω RDSON.
- Chip standby current = 10 μ A (typ)
- Flexible power up/down sequence
- Logic signals support 1.8 V I/O control
- Thermal protection
- 6 x 7 bump array, 0.4 mm pitch, WL-CSP, 2.86 x 2.46 mm
- KIT-PCA9460-EVB EVK: available

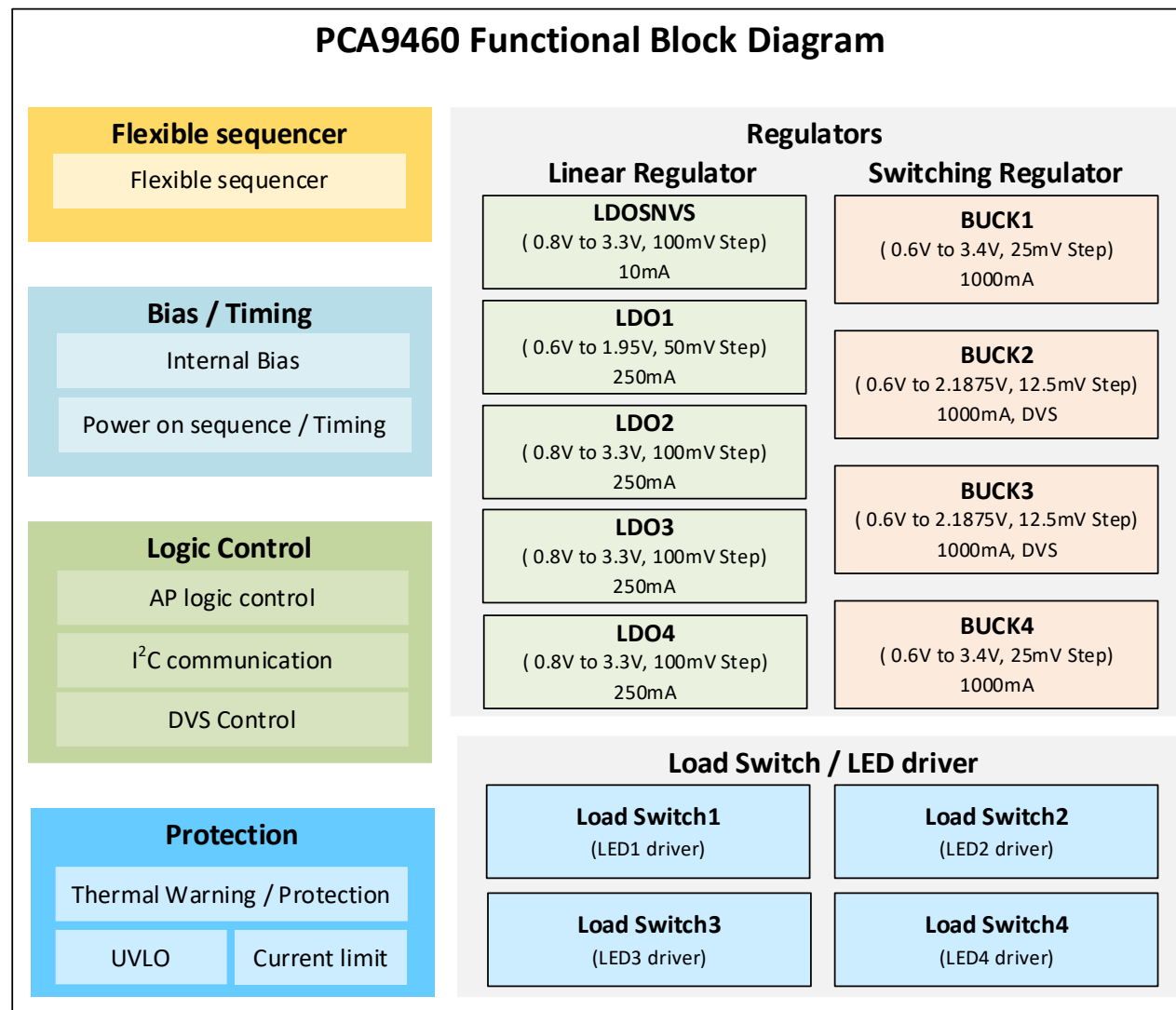

IN PRODUCTION

EXAMPLES OF TARGET APPLICATIONS

Low Power Devices



- Home control
- Wearables
- Portable healthcare
- Portable printing
- General embedded control
- IoT edge
- SOM board solutions

i.MX8 ULP + PCA9460 SUBSYSTEM: POWER AND CONTROL INTERACTION

- Logical control and interaction with i.MX 8ULP
 - IIC communication
 - Interrupt driven infrastructure
 - Simple ON and STANDBY entries.
 - Dynamic voltage scaling through ModeX pins or I2C
 - Watchdog timer
 - Fault detection and protection mechanisms

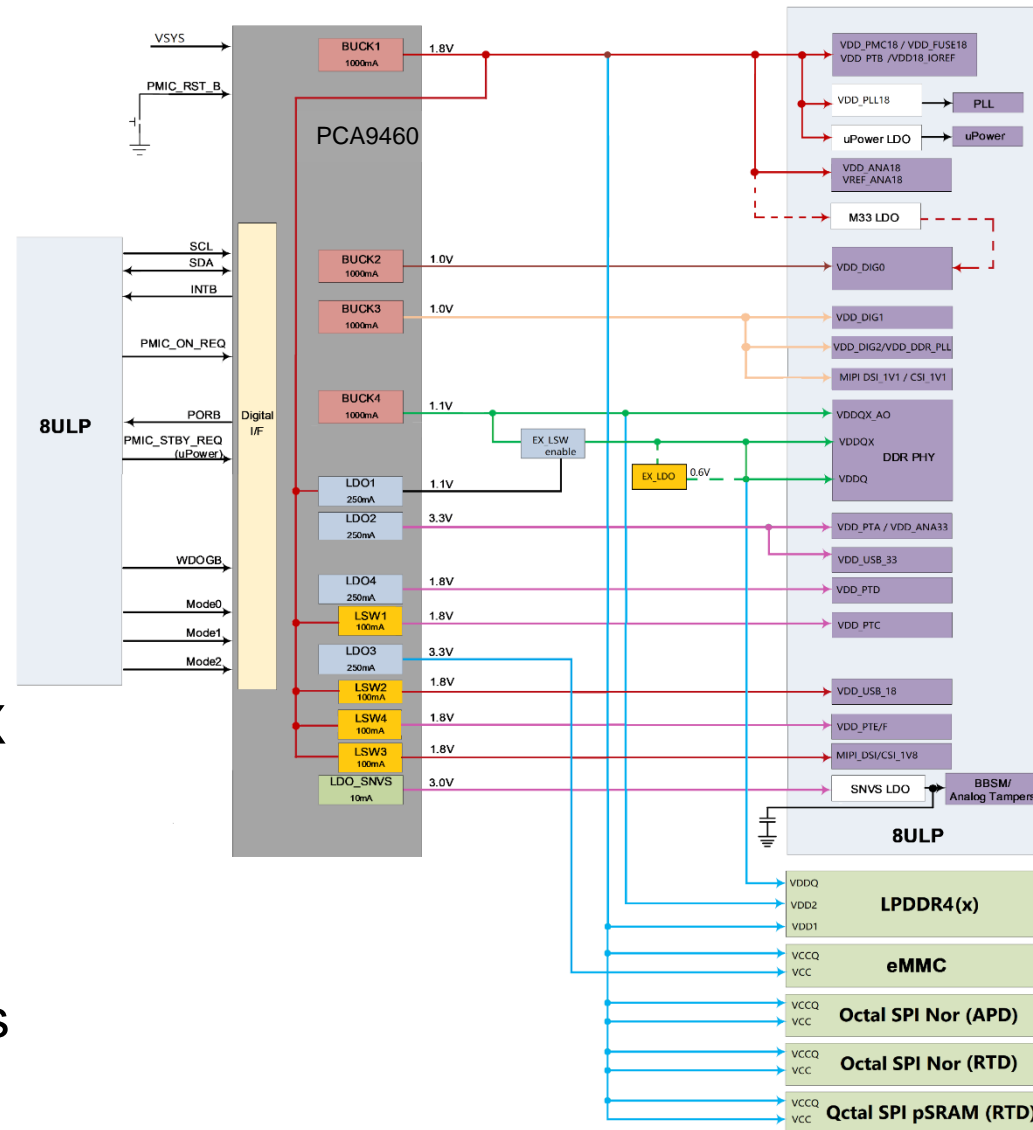

- Power supplies for i.MX 8ULP
 - Core and digital blocks
 - DDR PHY
 - Analog blocks
 - USB interface
 - I/O voltages
 - External memory supplies: DDR3/4/4X and eMMC/Octal SPI
 - Configurable load switches (PTC, VDD_USB, PTE and MIPI_CSI)

PCA9460 FAMILY MEMBERS – SUPPLY SELECTION GUIDE SUPPORTING DIFFERENT MEMORY TYPES

Part number	Processor Platform	Buck1 (1A)	Buck2 (1A)	Buck3 (1A)	Buck4 (1A)	LDO1 (250mA)	LDO2 (250mA)	LDO3 (250mA)	LDO4 (250mA)	LDO_SNVS (10mA)	Memory application tradeoffs
PCA9460A	i.MX 8ULP + LPDDR4	1.8V	1.0V	1.0V	1.1V	1.1V	3.3V	3.3V	1.8V	3.0V	Best tradeoff between power, performance and cost
PCA9460B	i.MX 8ULP + LPDDR4X	1.8V	1.0V	1.0V	1.1V	0.6V	3.3V	3.3V	1.8V	3.0V	Optimum performance and power consumption improved over LPDDR4.
PCA9460C	i.MX 8ULP + LPDDR3	1.8V	1.0V	1.0V	1.2V	1.2V	3.3V	3.3V	1.8V	3.0V	Most cost efficient, but least performing and higher power vs. LPDDR4

- Note:

- All these variants share the same turn-on and off sequencing.
- Output voltage can be changed with I2C command after device power up.

EVB AND TOOLS DOWNLOAD

- Full flexibility and configurability to exercise the PMIC in several use cases independently

	Status
PCA9460 EVB P/N: KIT-PCA9460-EVB	Available now in limited quantities. Reach out to your sales/FAE contact for more details
PCA9460 EVB User Manual	Preliminary version available now
PCA9460 Graphical User Interface	Preliminary version available now
FTDI Driver	https://www.ftdichip.com/Drivers/D2XX.htm

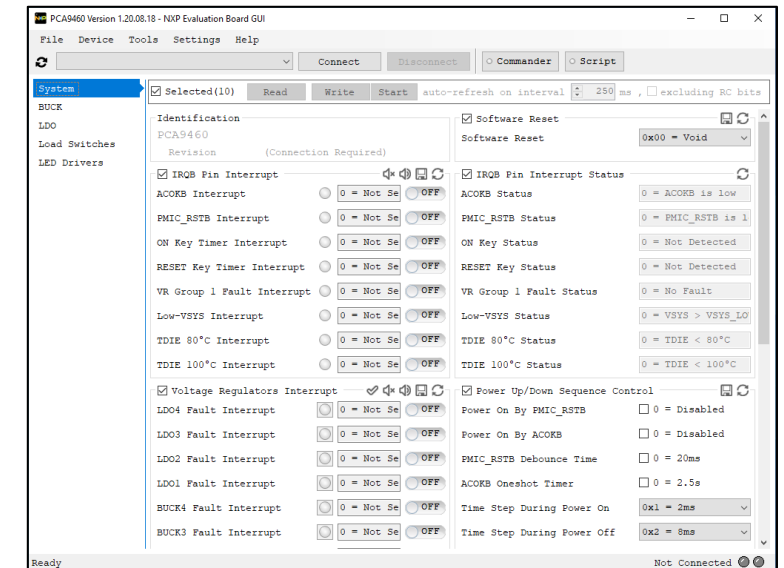
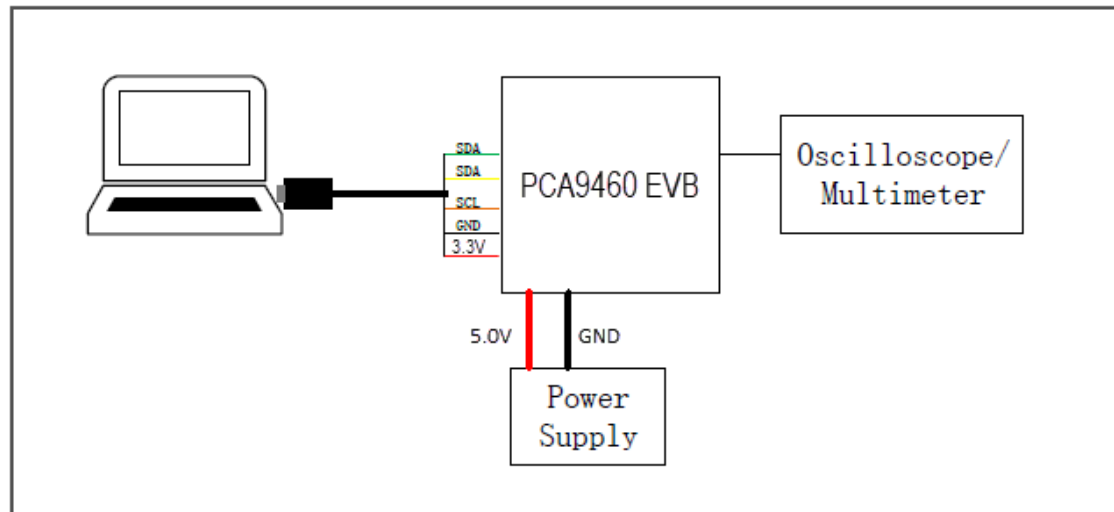

NXP SYSTEM SOLUTION TOTAL QUALITY

Proven System Solution

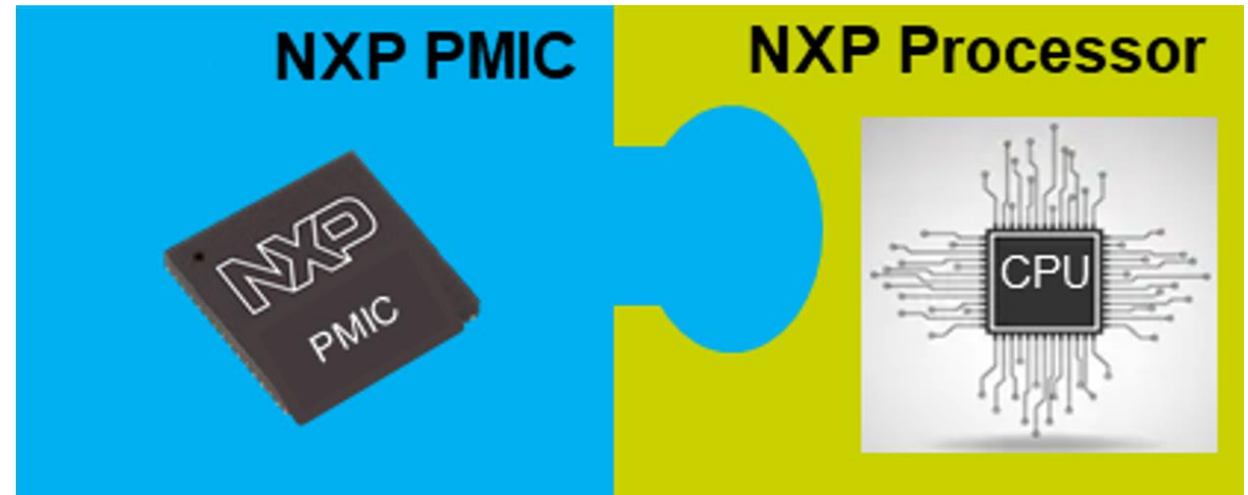

- Co-development for proven and robust system performance
 - In sync architecture aimed to optimize system performance and cost
 - Software development and support
 - Fully validated hardware and software implementation via reference designs
- Total quality with hardware and software optimized system solution
 - Lower risk and shorter time to market
 - NXP total system level support (Processor + PMIC)

PCA9460 PMIC (FOR i.MX 8ULP APPLICATIONS PROCESSOR)

Features List:

- **Four low Iq buck regulators**
 - 2 x 1 A buck regulators supporting DVFS
 - 2 x 1 A general purpose buck regulators
 - Quiescent current:
 - 1 μ A low power mode
 - 5 μ A in normal mode
 - Smart DVFS control
- **Five low Iq LDOs**
 - 1x 10 mA LDO, 4x 250 mA LDOs
 - 0.5 μ A quiescent current
- **Four load switches**
 - 1.2 V ~ 5.5 V
 - 100 m Ω RDSON.
- Chip standby current = 10 μ A (typ)
- Flexible power up/down sequence
- Logic signals support 1.8 V I/O control
- Thermal protection
- 6 x 7 bump array, 0.4 mm pitch, WL-CSP, 2.86 x 2.46 mm
- Samples available, SOP Q1 2022
- EVK: Initial batch available

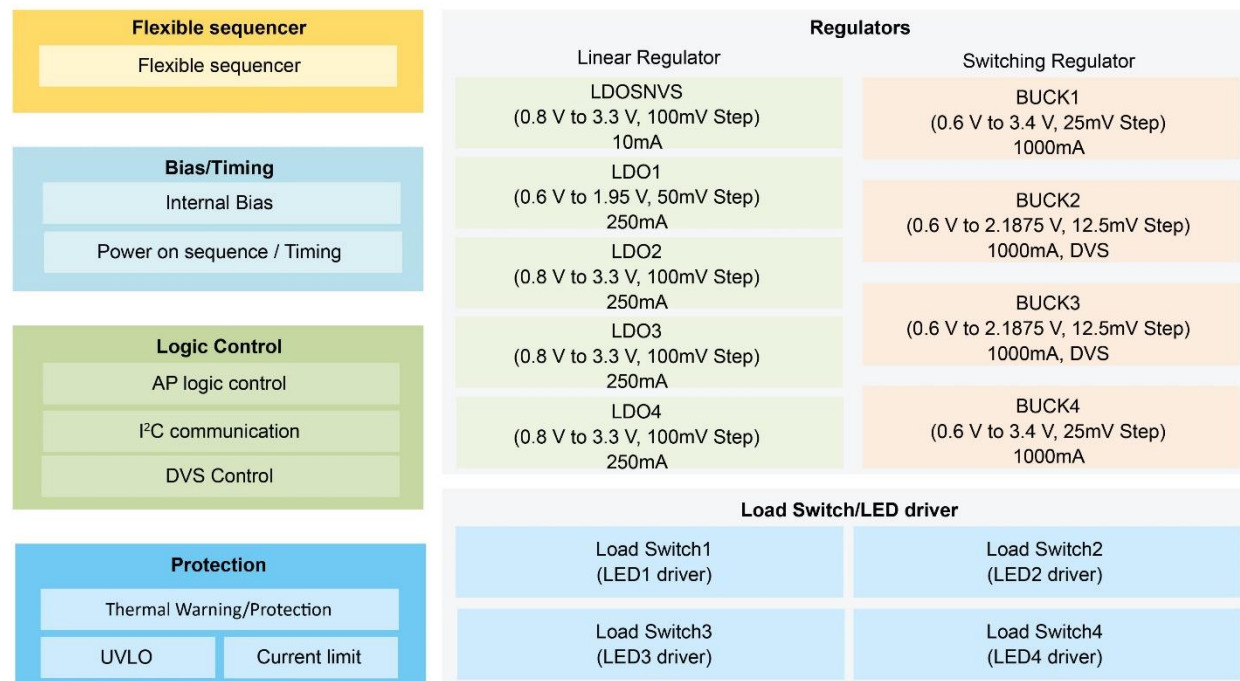

Device **SAMPLING**

PCA9460 EVB available

SOP Q1'2022