

# MIP SERIES

32354483  
Issue C

## Heavy Duty, Media-Isolated Pressure Transducers 1 bar to 60 bar | 15 psi to 870 psi

### DESCRIPTION

The MIP Series offers a heavy duty, media-isolated pressure transducer in a compact, stainless steel construction for use with a wide range of media including aggressive fluids and water. The MIP Series provides a cost-competitive solution for wide-ranging potential applications in tough environments.

### VALUE TO CUSTOMERS

- Total Error Band (TEB)  $\pm 0.75$  %FSS (Full Scale Span) from  $-40^{\circ}\text{C}$  to  $125^{\circ}\text{C}$  for ratiometric output: Provides true measurement performance over the compensated temperature range; small error promotes system uptime and efficiency (see Figure 5).
- 4 mA to 20 mA output: Supports transmission of output signals over longer distances
- EMC performance: Operates reliably in the presence of electromagnetic fields, such as wireless signals, RF communication, and electrical devices.
- Hermetically welded design: Supports almost any media without the use of an internal seal. The sensors are designed to be used in harsh environments which see aggressive media.

### DIFFERENTIATION

- Diagnostics: Beneficial in applications where the sensor functionality and the need to know internal or external failure modes is critical.
- Great customer value: Multiple configuration possibilities provide flexibility of use in the application with no up front NRE or tooling charges.
- Durable: Provides the tough environmental capabilities needed, including long-term stability, insulation resistance and dielectric strength, external freeze-thaw resistance for the Metri-Pack 150 versions and EMC performance.



Certified to  
NSF/ANSI/CAN 61



### FEATURES

- Rugged, stainless steel construction
- Ratiometric output: 0.5 Vdc to 4.5 Vdc
- Current output: 4 mA to 20 mA
- Operating temperature:  $-40^{\circ}\text{C}$  to  $125^{\circ}\text{C}$
- Total Error Band:  $\pm 0.75$  %FSS to  $\pm 1.0$  %FSS ( $-40^{\circ}\text{C}$  to  $125^{\circ}\text{C}$ ) for voltage output
- Industry-leading accuracy:  $\pm 0.15$  %FSS BFLS for voltage output
- Long term stability:  $\pm 0.25$  %FSS
- Radiated immunity: 100 V/m
- Drinking water approval: NSF/ANSI/CAN 61
- CE, UKCA, RoHS, REACH compliant
- Mis-wiring protection

TABLE 1. POTENTIAL APPLICATIONS

INDUSTRY	MEDIA
<b>Industrial:</b> pumps compressors process	water, hydraulic fluids compressed air food, beverage, oil, gas, steam
<b>HVAC/R</b>	refrigerants (butane, propane, ammonia, CO <sub>2</sub> , R134A, R407C, R410A, R448A/Solstice® N40, R32 and R1234ze, R1234yf, glycol + water
<b>Transportation</b>	gasoline, diesel fuel, engine oil, brake fluid, coolants, CNG
<b>Medical</b>	O <sub>2</sub> , N <sub>2</sub> , CO <sub>2</sub> , N <sub>2</sub> O, air



### PORTFOLIO

Honeywell offers a variety of heavy duty pressure transducers for potential use in industrial and transportation applications. To view the entire product portfolio, [click here](#).

**Honeywell**

# MIP SERIES HEAVY DUTY, MEDIA-ISOLATED PRESSURE TRANSDUCERS

**TABLE 2. ELECTRICAL SPECIFICATIONS (AT 25°C [77°F] AND UNDER UNLESS OTHERWISE NOTED.)**

CHARACTERISTIC	RATIOMETRIC OUTPUT (AA)	CURRENT OUTPUT (CH)
Supply voltage (V <sub>s</sub> )	5.0 Vdc ±0.25 Vdc	8 Vdc to 30 Vdc <sup>1</sup>
Output transfer function	10 % to 90 % of V <sub>s</sub>	4 mA to 20 mA
Output load (pull up or pull down)	≥ 2 kΩ	(V <sub>s</sub> - 8) × 50Ω <sup>2</sup>
Short circuit protection	yes	
Current consumption	6.5 mA ±1 mA	–
Over/reverse voltage	±40 Vdc	±35 Vdc

<sup>1</sup> Supply voltage: Must be de-rated to 8 Vdc to 25 Vdc for above 100°C to 125°C [212°F to 257°F].

<sup>2</sup> Applies at 25°C [77°F]. See Figure 4 for Current Output Supply Voltage.

**TABLE 3. PERFORMANCE SPECIFICATIONS (AT 25°C [77°F] AND UNDER UNLESS OTHERWISE NOTED.)**

CHARACTERISTIC	RATIOMETRIC OUTPUT	CURRENT OUTPUT
Total Error Band <sup>1</sup>	>10 bar or >150 psi: ±0.75 %FSS (-40°C to 125°C) ≤10 bar or ≤150 psi: ±1.0 %FSS <sup>2</sup> (-40°C to 125°C)	±1.0 %FSS (-20°C to 85°C) ±2.0 %FSS (-40°C to 125°C)
Operating temperature range	-40°C to 125°C [-40°F to 257°F]	
Accuracy BFSL <sup>3</sup>	±0.15 %FSS	±0.25 %FSS
Long term stability (1000 hr, 25°C)	±0.25 %FSS	
Typical output resolution	0.05 % Full Scale Pressure	
Typical response time <sup>4</sup>	1 ms	2 ms
Startup time <sup>5</sup>	7 ms	
EMC rating (CE Conformity): surge immunity (all leads) electrostatic discharge radiated immunity fast transient burst immunity to conducted disturbances radiated emissions	±1 kV line to ground per IEC 61000-4-5 ±4 kV contact, ±8 kV air per IEC 61000-4-2 10 V/m (80 MHz to 1000 MHz) per IEC 61000-4-3 ±1 kV per IEC 61000-4-4 3 V (150 kHz to 80 MHz) per IEC 61000-4-6 40 dBμV (30 MHz to 230 MHz), 47 dBμV (230 MHz to 1000 MHz) per CISPR 11	
Radiated immunity	100 V/m (200 MHz to 2.5 GHz) per ISO 11452-2	100 V/m (300 MHz to 2.7 GHz) per ISO 11452-2 100 V/m (100 kHz to 400 MHz) per ISO 11452-5
Insulation resistance	>100 MΩ at 1k Vdc (60 s)	
Dielectric strength	<1 mA at 500 Vac (60 s)	<1 mA at 1000 Vac (60 s)
Life	>10 million full scale pressure cycles	

<sup>1</sup> Total Error Band: The maximum deviation from the ideal transfer function over the entire compensated temperature and pressure range. Includes all errors due to offset, full scale span, pressure non-linearity, pressure hysteresis, pressure non-repeatability, thermal effect on offset, thermal effect on span, and thermal hysteresis (see Figure 5).

<sup>2</sup> TEB: Above 100°C [212°F] for pressure ratings less than 4 bar [58 psi], TEB is ±1.5 %FSS for ratiometric outputs and 2.0 % FSS for other outputs.

<sup>3</sup> Accuracy: The maximum deviation in output from a Best Fit Straight Line (BFSL) fitted to the output measured over the pressure range at 25°C [77°F]. Includes all errors due to pressure non-linearity, pressure hysteresis, and pressure non-repeatability.

<sup>4</sup> Response time: The time taken by the transducer to change output from 10 % to 90 % of full scale in response to a 0 % to 100 % full scale step input pressure.

<sup>5</sup> Startup time: The time needed to receive valid output after power up.

**TABLE 4. ENVIRONMENTAL AND MECHANICAL SPECIFICATIONS**

CHARACTERISTIC	PARAMETER
Shock	100 G per MIL-STD-202, Method 213, Cond. C (at 25°C [77°F])
Vibration	20 G sweep, 10 Hz to 2000 Hz (at 25°C [77°F])
Ingress protection: Metri-Pack 150 versions cable harness versions	IP65, IP67 IP65, IP67, IP69K
External freeze/thaw resistance	>6 cycles from -30°C to 50°C [-22°F to 122°F] (Metri-Pack 150 versions only)
Wetted materials: port diaphragm external seal for ports	stainless steel 304L stainless steel 316L nitrile (-30°C to 100°C [-22°F to 212°F]) (other materials available)
Electrical connector material	PBT 30 %GF (UL V-0)
Cable material (jacket and insulation)	TPE (Thermoplastic Elastomer) flame retardant-type cable is FT1 rated per CSA AWM-I-A/B-II-A/B specification, -40°C to 125°C [-40°F to 257°F], three 24 AWG wires.

# MIP SERIES HEAVY DUTY, MEDIA-ISOLATED PRESSURE TRANSDUCERS

FIGURE 1. NOMENCLATURE AND ORDER GUIDE

For example, **MIPAN1XX010BSAAX** defines an MIP Series Heavy Duty, Media Isolated Pressure Transducer, Metri-Pack 150, standard (UL V-0) electrical connector type, 1/4-18 NPT pressure port type, 10 bar pressure range, sealed gage pressure reference, ratiometric: 5 Vs, 10% to 90% Vs output transfer function





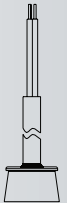

**MIP A N1 X X 010B S AA X<sup>1</sup>**

**Series**  
**MIP** Media Isolated Pressure

**Electrical Connector Type**

<b>A</b>	Metri-Pack 150, Standard (UL V-0)	
<b>K</b>	Cable harness <sup>2</sup> , 0.5 m [1.3 ft] cable length	
<b>E</b>	Cable harness <sup>2</sup> , 1.0 m [3.2 ft] cable length	
<b>F</b>	Cable harness <sup>2</sup> , 2.0 m [6.6 ft] cable length	
<b>G</b>	Cable harness for CH output transfer function <sup>2</sup> , 3.0 m [9.8 ft] cable length	
<b>H</b>	Cable harness for CH output transfer function <sup>2</sup> , 5.0 m [16.4 ft] cable length	

**Pressure Port Type**

<b>F1</b>	7/16-20 UNF 1/4 inch 45° Flare Female Schrader (SAE J512)	
<b>G1</b>	G1/4 A-G <sup>3</sup> (ISO 1179-3)	
<b>G2</b>	G1/4 A-L <sup>3</sup> (ISO 1179-2)	
<b>M1</b>	M12 x 1.5 <sup>3</sup> (ISO 6149-3)	
<b>N1</b>	1/4-18 NPT (ANSI/ASME B1.20.1)	
<b>N2</b>	1/8-27 NPT (ANSI/ASME B1.20.1)	

**Special**  
**X**

**Output Transfer Function**

<b>AA</b>	Ratiometric: 5.0 Vs, 10% to 90% Vs
<b>CH</b>	Current: 4 mA to 20 mA

**Pressure Reference**

<b>A</b>	Absolute
<b>S</b>	Sealed gage <sup>4</sup>

**Pressure Range**

bar		psi	
<b>001B</b>	1 bar	<b>020B</b>	20 bar
<b>002B</b>	2 bar	<b>025B</b>	25 bar
<b>004B</b>	4 bar	<b>035B</b>	35 bar
<b>006B</b>	6 bar	<b>040B</b>	40 bar
<b>008B</b>	8 bar	<b>046B</b>	46 bar
<b>010B</b>	10 bar	<b>050B</b>	50 bar
<b>012B</b>	12 bar	<b>055B</b>	55 bar
<b>016B</b>	16 bar	<b>060B</b>	60 bar
<b>015P</b>	15 psi	<b>500P</b>	500 psi
<b>030P</b>	30 psi	<b>600P</b>	600 psi
<b>050P</b>	50 psi	<b>667P</b>	667 psi
<b>060P</b>	60 psi	<b>700P</b>	700 psi
<b>100P</b>	100 psi	<b>750P</b>	750 psi
<b>150P</b>	150 psi	<b>800P</b>	800 psi
<b>200P</b>	200 psi	<b>850P</b>	850 psi
<b>250P</b>	250 psi	<b>870P</b>	870 psi
<b>300P</b>	300 psi		

**Special**  
**X**

**Special**  
**X**

<sup>1</sup> Contact Honeywell Sales for custom configurations.  
<sup>2</sup> See Table 4 for cable material specifications.  
<sup>3</sup> Other external seal materials are available for G1, G2, and M1 Pressure port types.  
<sup>4</sup> Sealed gage option only available in pressure ranges at or above 8 bar | 100 psi.

## CAUTION PRODUCT DAMAGE DUE TO MISUSE

- Ensure torque specifications are determined for the specific application. Values provided are for reference only. (Mating materials and thread sealants can result in significantly different torque values from one application to the next.)
  - Use appropriate tools (such as an open-ended wrench or deep well socket) to install transducers.
  - Ensure that the proper mating electrical connector with a seal is used to connect the transducer. Improper or damaged seals can compromise ingress protection, leading to short circuits.
  - Ensure that filters are used upstream of the transducers to keep media flow free of particulates. MIP Series transducers are dead-end devices. Particulate accumulation may clog the port or damage the diaphragm.
  - Ensure that the transducer is mounted in a vertical position with the process connection (pressure port) downward to avoid particular deposits.
  - Ensure that the media does not create a residue when dried. Build-up of residue inside the transducer may affect transducer output.
  - Ensure that the transducer housing is properly grounded.
  - For cable harness versions, ensure that the cable bend radius is maintained at a minimum of 38 mm [1.50 in] in the end application assembly.
- Failure to comply with these instructions may result in product damage.**

# MIP SERIES HEAVY DUTY, MEDIA-ISOLATED PRESSURE TRANSDUCERS

**TABLE 5. PRESSURE RATINGS**

BAR			PSI		
OPERATING PRESSURE	OVER-PRESSURE <sup>1</sup>	BURST PRESSURE <sup>2</sup>	OPERATING PRESSURE	OVER-PRESSURE <sup>1</sup>	BURST PRESSURE <sup>2</sup>
1 to 3	6	207	15 to 43.5	87	3000
>3 to 12	24		>43.5 to 174	348	
>12 to 60	120		>174 to 870	1740	

<sup>1</sup>**Overpressure:** The maximum pressure which may safely be applied to the product for it to remain in specification once pressure is returned to the operating pressure range. Exposure to higher pressures may cause permanent damage to the product.

<sup>2</sup>**Burst Pressure:** The maximum pressure which may be applied without causing escape of pressure media. The product should not be expected to function after exposure to the burst pressure.

**FIGURE 2. RATIO-METRIC OUTPUT TRANSFER FUNCTION**

The transfer function shown here is applicable to a ratiometric output ranging between 10%  $V_{supply}$  at null pressure to 90%  $V_{supply}$  at full scale pressure.

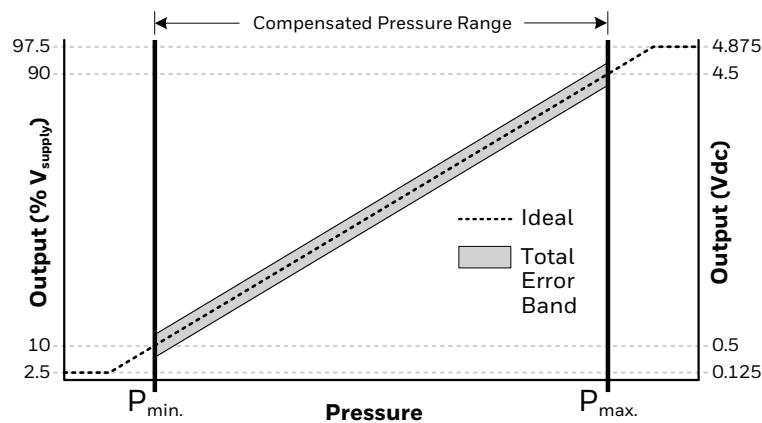

$$\text{Output (V)} = \frac{0.8 \times V_{supply}}{P_{max} - P_{min}} \times (\text{Pressure}_{applied} - P_{min}) + 0.10 \times V_{supply}$$

**FIGURE 3. ABSOLUTE VS SEALED GAGE**

Example shown is for 100 psi.

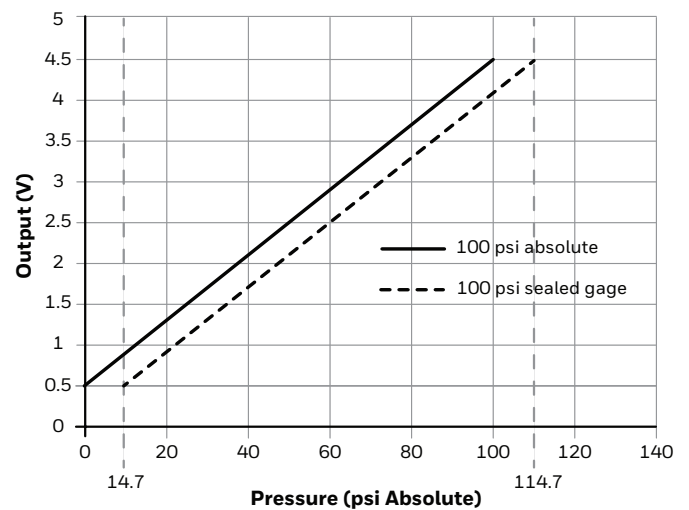

**FIGURE 4. CURRENT OUTPUT SUPPLY VOLTAGE VS TEMPERATURE**

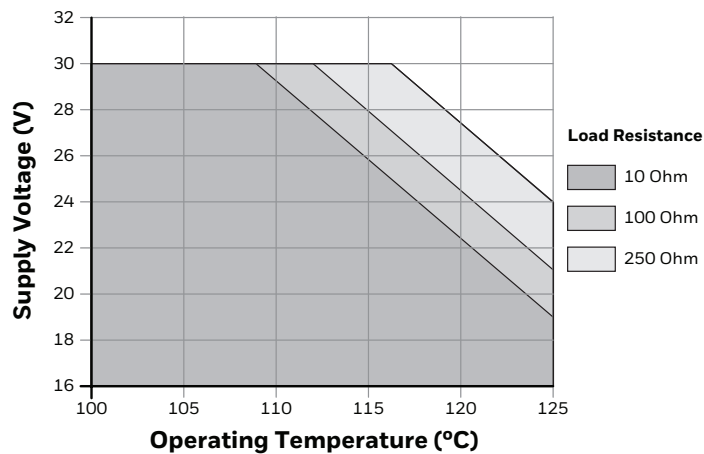

# MIP SERIES HEAVY DUTY, MEDIA-ISOLATED PRESSURE TRANSDUCERS

## TOTAL ERROR BAND

Total Error Band (TEB) is a single specification that includes the major sources of sensor error. TEB should not be confused with accuracy, which is actually a component of TEB. TEB is the maximum error that the sensor could experience.

Honeywell uses the TEB specification in its datasheet because it is the most comprehensive measurement of a sensor's true accuracy. Honeywell also provides the accuracy specification in order to provide a common comparison with competitors' literature that does not use the TEB specification.

Many competitors do not use TEB—they simply specify the accuracy of their device. Their accuracy specification, however, may exclude certain parameters. On their datasheet, the errors are listed individually. When combined, the total error (or what would be TEB) could be significant.

**FIGURE 5. TEB COMPONENTS FOR THE MIP SERIES**

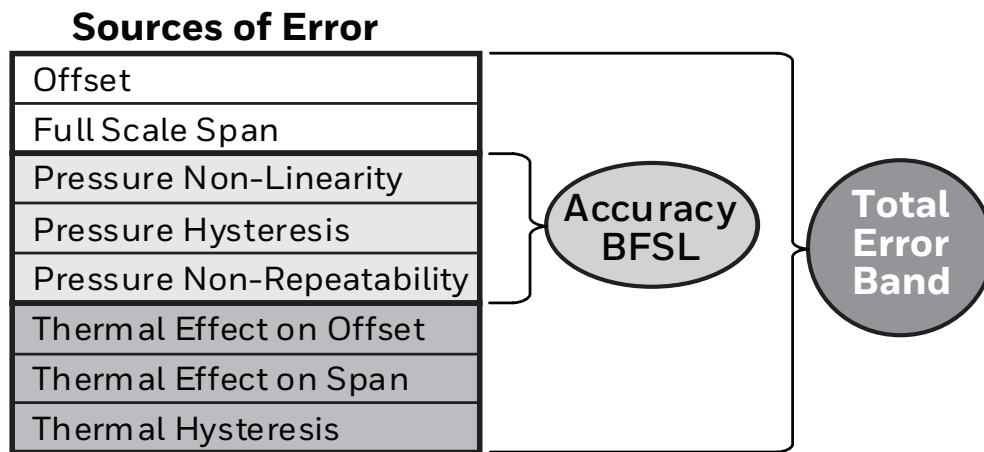
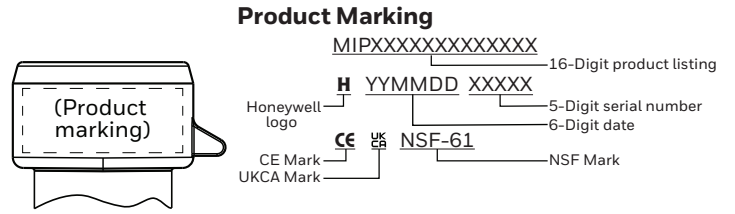
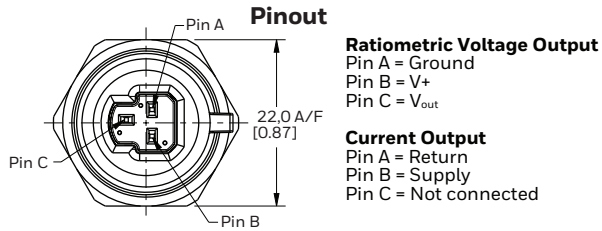

**TABLE 6. OUTPUT DIAGNOSTIC CODE FOR RATIOMETRIC OUTPUT**

FAULT CONDITION	ANALOG DIAGNOSTIC RAIL
<b>Sensor internal failures</b>	97.5 % of $V_{supply}$ (See Figure 2.)
<b>Over pressure</b>	97.5 % of $V_{supply}$ (See Figure 2.)
<b>Under pressure (for sealed gage only)</b>	2.5 % of $V_{supply}$ (See Figure 2.)
<b>Power or ground loss</b>	high (external pull-up resistor)
<b>Power or ground loss</b>	low (external pull-down resistor)

# MIP SERIES HEAVY DUTY, MEDIA-ISOLATED PRESSURE TRANSDUCERS

FIGURE 6. METRI-PACK 150 MOUNTING DIMENSIONS (FOR REFERENCE ONLY. MM/[IN])



**F1: 7/16-20 UNF 1/4 inch 45° Flare Female Schrader (SAE J512)**

Seal: 45° cone  
 Mating geometry: SAE J512  
 Installation torque: 17 N m [12 ft-lb]  
 Weight: 36 g [1.3 oz]

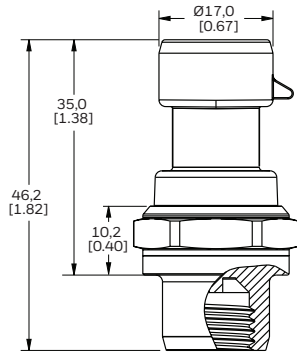

**G1: G1/4 A-G (ISO 1179-3)**

Seal: O-ring (included) and retaining ring ISO 1179-3-G1/4 (not included)  
 Mating geometry: ISO 1179-1  
 Installation torque: 20 N m [14.7 ft-lb]  
 Weight: 33 g [1.1 oz]

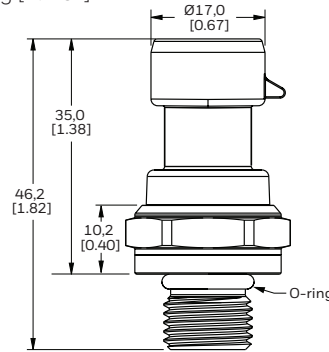

**G2: G1/4 A-L (ISO 1179-2)**

Seal: ISO 9974-2/DIN 3869 profile ring (included)  
 Mating geometry: ISO 1179-1  
 Installation torque: 20 N m [15 ft-lb]  
 Weight: 36 g [1.3 oz]

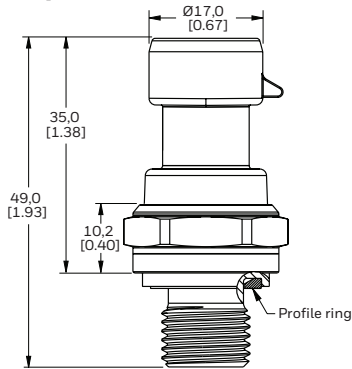

**M1: M12 x 1.5 (ISO 6149-3)**

Seal: O-ring (included)  
 Mating geometry: ISO 6149-1  
 Installation torque: 20 N m [15 ft-lb]  
 Weight: 34 g [1.2 oz]

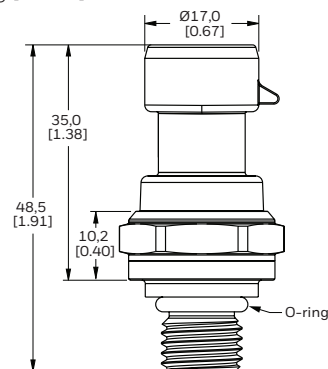

**N1: 1/4-18 NPT**

Seal: Pipe thread  
 Mating geometry: ANSI B1.20.1  
 Installation torque: Two to three turns from finger tight  
 Weight: 38 g [1.3 oz]

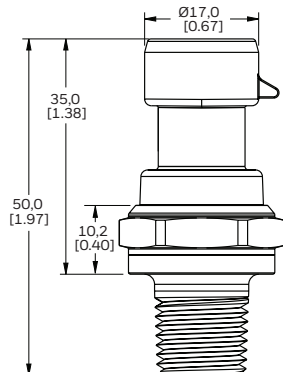

**N2: 1/8-27 NPT**

Seal: Pipe thread  
 Mating geometry: ANSI B1.20.1  
 Installation torque: Two to three turns from finger tight  
 Weight: 30 g [1.0 oz]

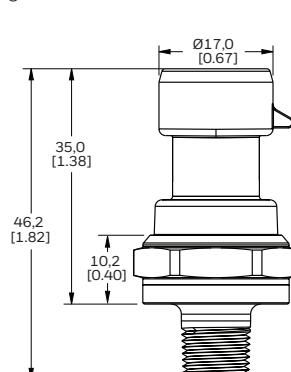

# MIP SERIES HEAVY DUTY, MEDIA-ISOLATED PRESSURE TRANSDUCERS

FIGURE 7. CABLE HARNESS MOUNTING DIMENSIONS (FOR REFERENCE ONLY. MM/[IN])

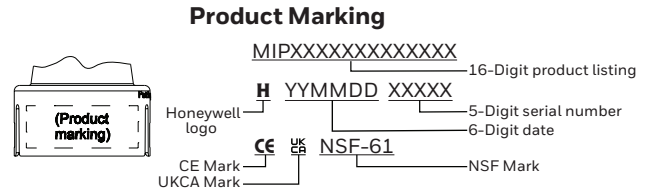
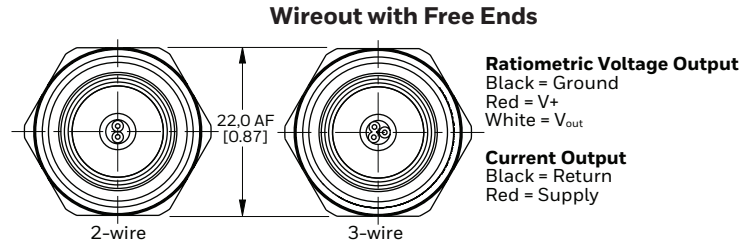

**F1: 7/16-20 UNF 1/4 inch 45° Flare Female Schrader (SAE J512)**

Seal: 45° cone  
 Mating geometry: SAE J512  
 Installation torque: 17 N m [12 ft-lb]  
 Weight: 68 g [2.4 oz]

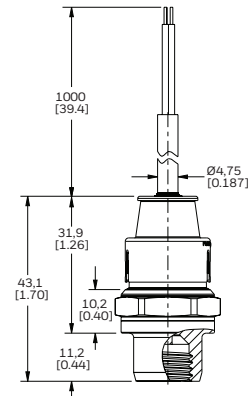

**G1: G1/4 A-G (ISO 1179-3)**

Seal: O-ring (included) and retaining ring ISO 1179-3-G1/4 (not included)  
 Mating geometry: ISO 1179-1  
 Installation torque: 20 N m [14.7 ft-lb]  
 Weight: 65 g [2.3 oz]

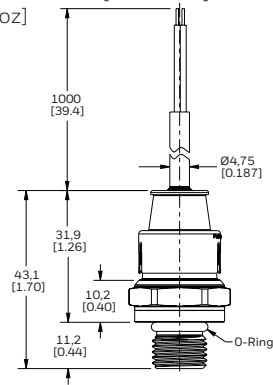

**G2: G1/4 A-L (ISO 1179-2)**

Seal: ISO 9974-2/DIN 3869 profile ring (included)  
 Mating geometry: ISO 1179-1  
 Installation torque: 20 N m [15 ft-lb]  
 Weight: 68 g [2.4 oz]

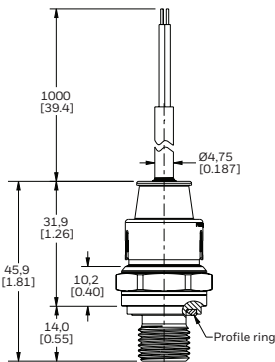

**M1: M12 x 1.5 (ISO 6149-3)**

Seal: O-ring (included)  
 Mating geometry: ISO 6149-1  
 Installation torque: 20 N m [15 ft-lb]  
 Weight: 66 g [2.3 oz]

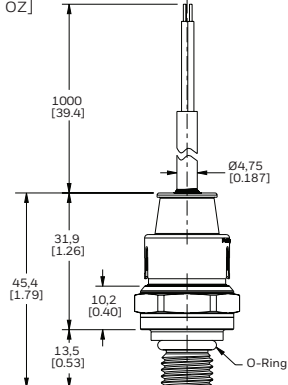

**N1: 1/4-18 NPT**

Seal: Pipe thread  
 Mating geometry: ANSI B1.20.1  
 Installation torque: Two to three turns from finger tight  
 Weight: 79 g [2.5 oz]

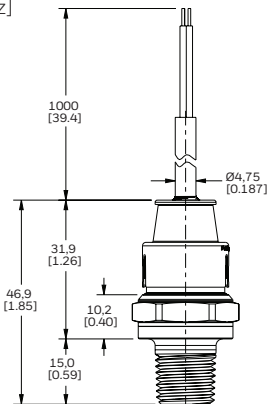

**N2: 1/8-27 NPT**

Seal: Pipe thread  
 Mating geometry: ANSI B1.20.1  
 Installation torque: Two to three turns from finger tight  
 Weight: 62 g [2.2 oz]

