

Six-Pack XPT IGBT

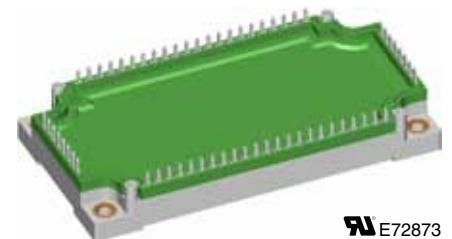
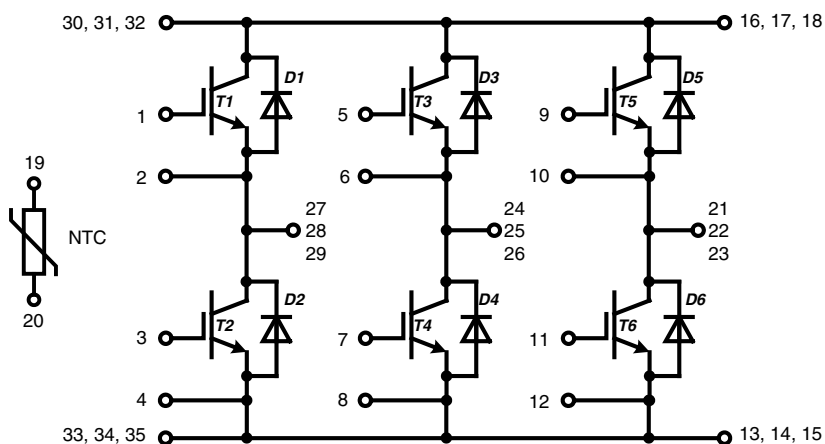
$$V_{CES} = 1200 \text{ V}$$

$$I_{C25} = 220 \text{ A}$$

$$V_{CE(sat)} = 1.8 \text{ V}$$

Part name (Marking on product)

MIXA150W1200TEH



IXYS E72873

Pin configuration see outlines.

Features:

- Easy paralleling due to the positive temperature coefficient of the on-state voltage
- Rugged XPT design (Xtreme light Punch Through) results in:
 - short circuit rated for 10 μ sec.
 - very low gate charge
 - square RBSOA @ 3x I_C
 - low EMI
- Thin wafer technology combined with the XPT design results in a competitive low $V_{CE(sat)}$
- SONIC™ diode
 - fast and soft reverse recovery
 - low operating forward voltage

Application:

- AC motor drives
- Solar inverter
- Medical equipment
- Uninterruptible power supply
- Air-conditioning systems
- Welding equipment
- Switched-mode and resonant-mode power supplies

Package:

- "E3-Pack" standard outline
- Insulated copper base plate
- Soldering pins for PCB mounting
- Temperature sense included
- Optimizes pin layout

Output Inverter T1 - T6

Symbol	Definitions	Conditions	Ratings			Unit	
			min.	typ.	max.		
V_{CES}	collector emitter voltage		$T_{VJ} = 25^{\circ}\text{C}$		1200	V	
V_{GES}	max. DC gate voltage	continuous			± 20	V	
V_{GEM}	max. transient collector gate voltage	transient			± 30	V	
I_{C25}	collector current		$T_C = 25^{\circ}\text{C}$		220	A	
I_{C80}			$T_C = 80^{\circ}\text{C}$		150	A	
P_{tot}	total power dissipation		$T_C = 25^{\circ}\text{C}$		695	W	
$V_{CE(sat)}$	collector emitter saturation voltage	$I_C = 150\text{ A}; V_{GE} = 15\text{ V}$	$T_{VJ} = 25^{\circ}\text{C}$ $T_{VJ} = 125^{\circ}\text{C}$	1.8 2.1	2.1	V V	
$V_{GE(th)}$	gate emitter threshold voltage	$I_C = 6\text{ mA}; V_{GE} = V_{CE}$	$T_{VJ} = 25^{\circ}\text{C}$	5.4	6.0	6.5	V
I_{CES}	collector emitter leakage current	$V_{CE} = V_{CES}; V_{GE} = 0\text{ V}$	$T_{VJ} = 25^{\circ}\text{C}$ $T_{VJ} = 125^{\circ}\text{C}$		0.05 1.0	0.5 mA mA	
I_{GES}	gate emitter leakage current	$V_{GE} = \pm 20\text{ V}$			500	nA	
$Q_{G(on)}$	total gate charge	$V_{CE} = 600\text{ V}; V_{GE} = 15\text{ V}; I_C = 150\text{ A}$			470	nC	
$t_{d(on)}$	turn-on delay time	inductive load $V_{CE} = 600\text{ V}; I_C = 150\text{ A}$ $V_{GE} = \pm 15\text{ V}; R_G = 4.7\ \Omega$	$T_{VJ} = 125^{\circ}\text{C}$		70	ns	
t_r	current rise time				40	ns	
$t_{d(off)}$	turn-off delay time				250	ns	
t_f	current fall time				100	ns	
E_{on}	turn-on energy per pulse				14	mJ	
E_{off}	turn-off energy per pulse				16	mJ	
E_{rec}	diode turn-off energy per pulse				10	mJ	
RBSOA	reverse bias safe operating area	$V_{GE} = \pm 15\text{ V}; R_G = 4.7\ \Omega;$	$T_{VJ} = 125^{\circ}\text{C}$ $V_{CEK} = 1200\text{ V}$		450	A	
SCSOA	short circuit safe operating area						
t_{SC}	short circuit duration	$V_{CE} = 900\text{ V}; V_{GE} = \pm 15\text{ V};$ $R_G = 4.7\ \Omega;$ non-repetitive	$T_{VJ} = 125^{\circ}\text{C}$		10	μs	
I_{SC}	short circuit current			600		A	
R_{thJC}	thermal resistance junction to case	(per IGBT)			0.18	K/W	

Output Inverter D1 - D6

Symbol	Definitions	Conditions	Ratings			Unit
			min.	typ.	max.	
V_{RRM}	max. repetitive reverse voltage		$T_{VJ} = 25^{\circ}\text{C}$		1200	V
I_{F25}	forward current		$T_C = 25^{\circ}\text{C}$		190	A
I_{F80}			$T_C = 80^{\circ}\text{C}$		130	A
V_F	forward voltage	$I_F = 150\text{ A}; V_{GE} = 0\text{ V}$	$T_{VJ} = 25^{\circ}\text{C}$ $T_{VJ} = 125^{\circ}\text{C}$	1.95 1.95	2.2	V V
Q_{rr}	reverse recovery charge	$V_R = 600\text{ V}$ $di_f/dt = -2500\text{ A}/\mu\text{s}$ $I_F = 150\text{ A}; V_{GE} = 0\text{ V}$	$T_{VJ} = 125^{\circ}\text{C}$		20	μC
I_{RM}	max. reverse recovery current				175	A
t_{rr}	reverse recovery time				350	ns
E_{rec}	reverse recovery energy				10	mJ
R_{thJC}	thermal resistance junction to case	(per diode)			0.28	K/W

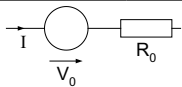
 $T_C = 25^{\circ}\text{C}$ unless otherwise stated

Temperature Sensor NTC

Symbol	Definitions	Conditions	Ratings			Unit
			min.	typ.	max.	
R_{25}	resistance	$T_C = 25^\circ\text{C}$	4.75	5.0	5.25	k Ω
$B_{25/50}$				3375		K

Module

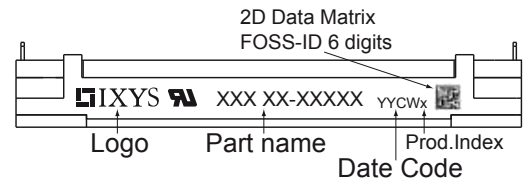
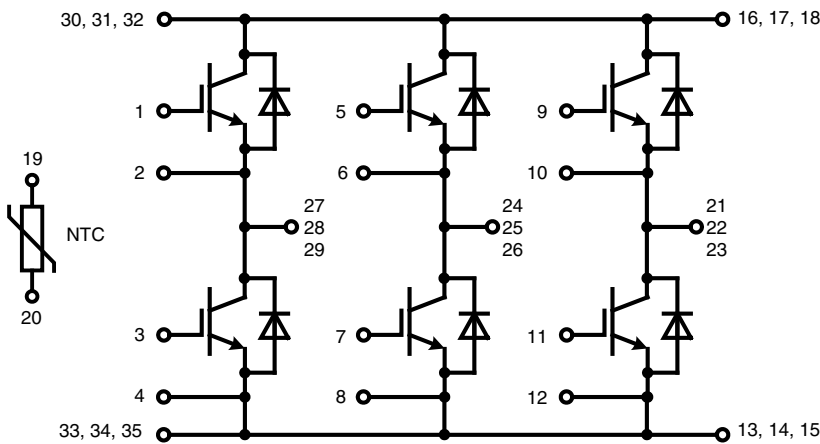
Symbol	Definitions	Conditions	Ratings			Unit
			min.	typ.	max.	
T_{VJ}	operating temperature		-40		125	$^\circ\text{C}$
T_{VJM}	max. virtual junction temperature				150	$^\circ\text{C}$
T_{stg}	storage temperature		-40		125	$^\circ\text{C}$
V_{ISOL}	isolation voltage	$I_{ISOL} \leq 1 \text{ mA}; 50/60 \text{ Hz}$			3000	V~
CTI	comparative tracking index				200	
M_d	mounting torque (M5)		3		6	Nm
d_S	creep distance on surface		10			mm
d_A	strike distance through air		7.5			mm
$R_{pin-chip}$	resistance pin to chip			2.5		m Ω
R_{thCH}	thermal resistance case to heatsink	with heatsink compound		0.02		K/W
Weight				300		g

Equivalent Circuits for Simulation


Symbol	Definitions	Conditions	Ratings			Unit
			min.	typ.	max.	
V_0	IGBT	T1 - T6	$T_{VJ} = 150^\circ\text{C}$		1.1	V
R_0					9.2	m Ω
V_0	free wheeling diode	D1 - D6	$T_{VJ} = 150^\circ\text{C}$		1.25	V
R_0					5.7	m Ω

 $T_C = 25^\circ\text{C}$ unless otherwise stated

Circuit Diagram

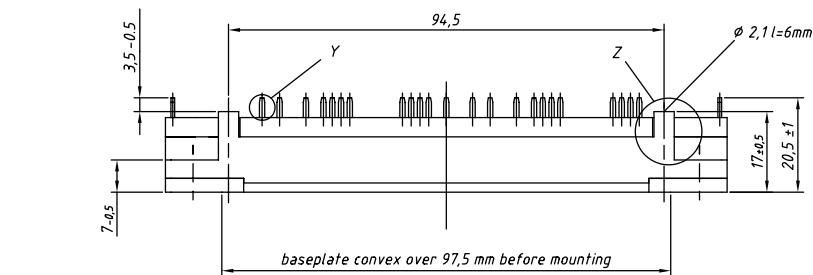


Part number

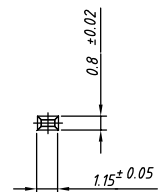
- M = Module
- I = IGBT
- X = XPT
- A = standard
- 150 = Current Rating [A]
- W = Six-Pack
- 1200 = Reverse Voltage [V]
- T = NTC
- EH = E3-Pack

Outline Drawing

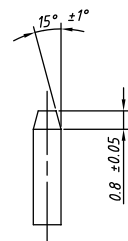
Dimensions in mm (1 mm = 0.0394")



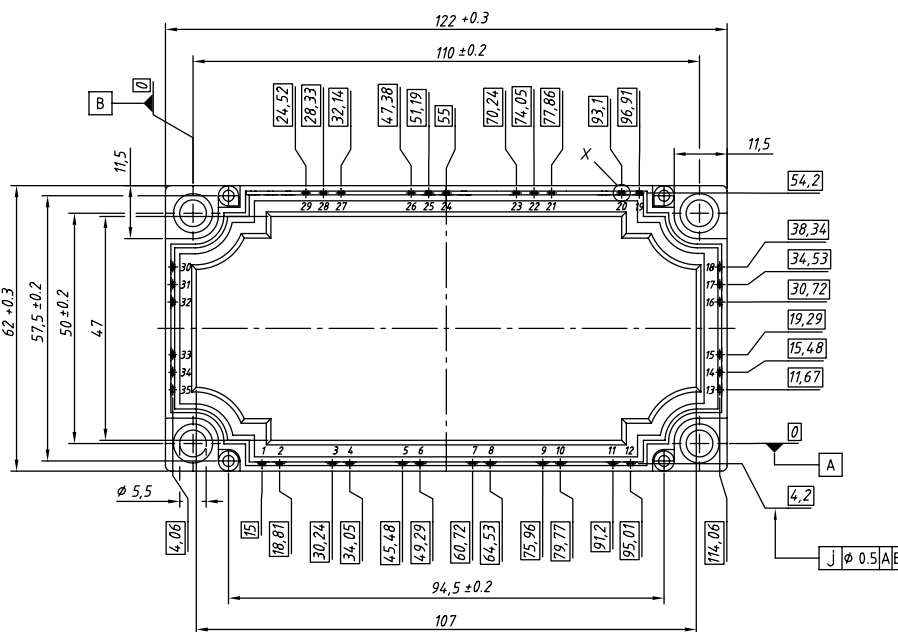
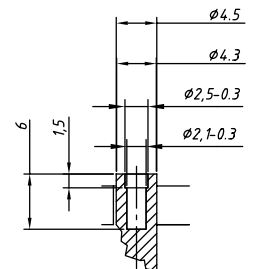
Detail X



Detail Y



Detail Z



Product Marking

Ordering	Part Name	Marking on Product	Delivering Mode	Base Qty	Ordering Code
Standard	MIXA150W1200 TEH	MIXA150W1200TEH	Box	5	509654

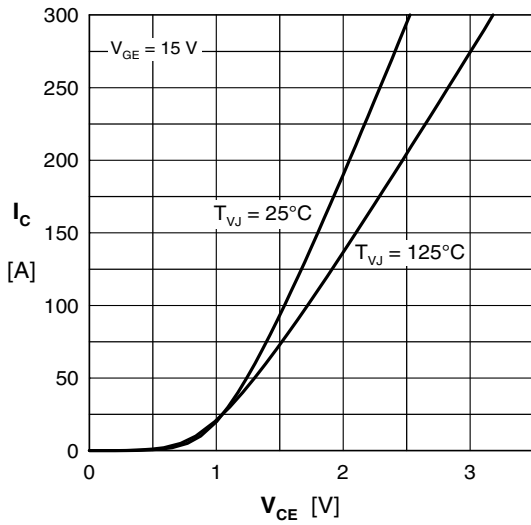
Transistor T1 - T6


Fig. 1 Typ. output characteristics

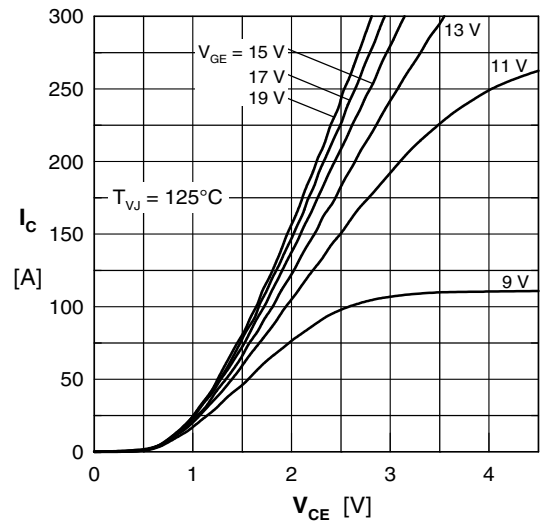


Fig. 2 Typ. output characteristics

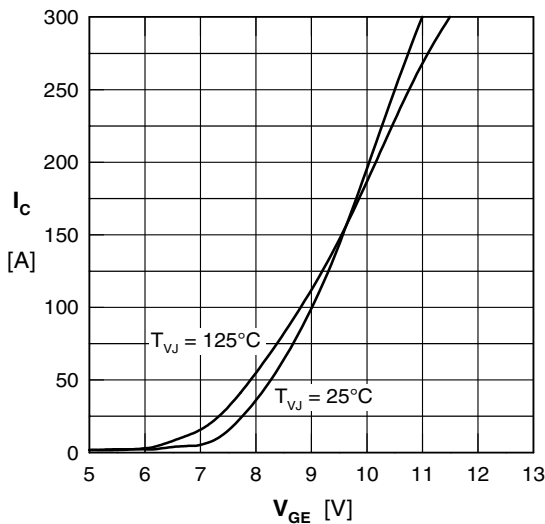


Fig. 3 Typ. transfer characteristics

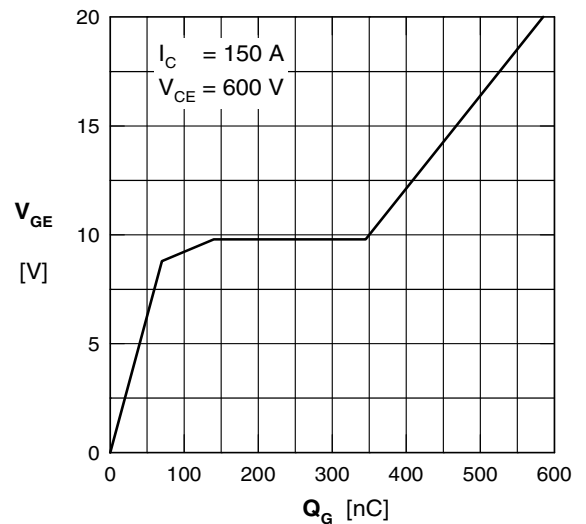


Fig. 4 Typ. turn-on gate charge

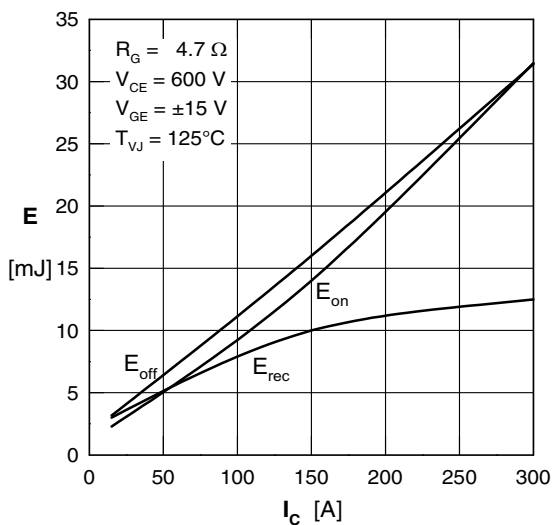


Fig. 5 Typ. switching energy vs. collector current

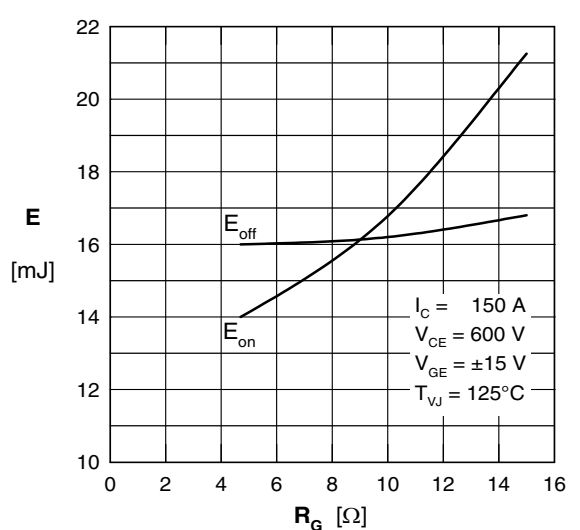


Fig. 6 Typ. switching energy vs. gate resistance