

DC to 30GHz Broadband MMIC Low-Noise Amplifier

Features

- Low noise, ultra-flat gain 6-20GHz:
 - 2.5dB NF, 18 ± 0.3 dB gain
- Excellent 1.5-20GHz performance:
 - Very flat gain (17 ± 0.6 dB)
 - High Psat at 20GHz (20dBm)
 - High P1dB at 20GHz (17dBm)
- Wideband operation: 0.04-30GHz
- Good input / output return loss
- High isolation
- >30dB dynamic gain control
- Integrated temperature-referenced power detector output
- 100% DC, RF, and visually tested
- Size: 2390x920um (94.1x36.2mil)

Description

The MMA022AA is an eight stage traveling wave amplifier. The amplifier has been designed for low noise, flat gain, and good return loss to 30GHz. The amplifier typically has 2.5dB NF and 17dB gain from 6-20GHz, and 16dB gain from 0.04-30GHz.

Application

The MMA022AA Broadband MMIC Low-Noise Amplifier is designed for low-noise and broadband flat-gain applications in RF and microwave communications, test equipment and military systems. By using specific external components, the bandwidth of operation can be extended below 40MHz.

Key Characteristics: Vdd=5.0V, Idd=150mA, Zo=50Ω

Specifications pertain to wafer measurements with RF probes and DC bias cards @ 25°C

Parameter	Description	6 - 20GHz			1.5 - 20GHz			0.04 - 30GHz		
		Min	Typ	Max	Min	Typ	Max	Min	Typ	Max
S21 (dB)	Small Signal Gain	16	17	-	16	17	-	14	16.5	-
Flatness (±dB)	Gain Flatness	-	0.3	0.6	-	0.6	1.0	-	1.5	2.0
S11 (dB)	Input Match	-	-16	-13	-	-16	-13	-	-10	-8
S22 (dB)	Output Match	-	-18	-15	-	-18	-15	-	-18	-15
S12 (dB)	Reverse Isolation	-	-35	-30	-	-35	-30	-	-30	-25
P1dB (dBm)	1dB Compressed Output Power	16	17	-	16	17	-	12	13.5	-
Psat (dBm)	Saturated Output Power	19	20	-	19	20	-	14	16.5	-
Pout @ 16dB (dBm)	Output Power at 16dB Gain	17	18.5	-	17	18.5	-	-	-	-
NF (dB)	Noise Figure	-	2.5	-	-	5	-	-	5.5	-
RF _{det} (mV/mW)	RF Detector Sensitivity	-	0.5	-	-	0.5	-	-	0.5	-

Typical Performance

S21

Noise Figure

S11, S22

S12

Output Power

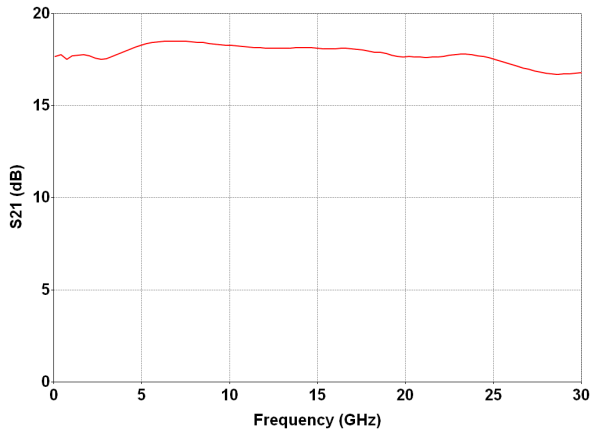
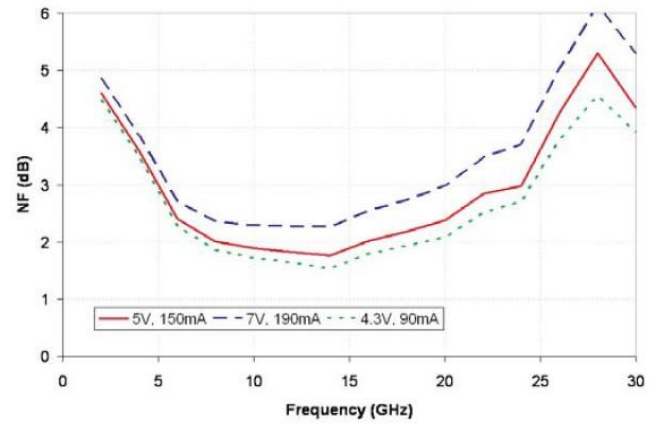
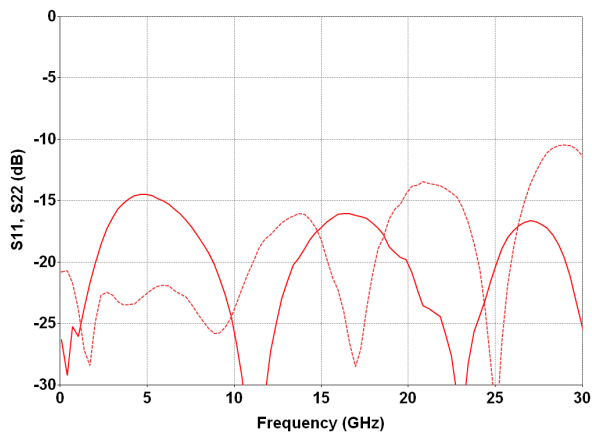
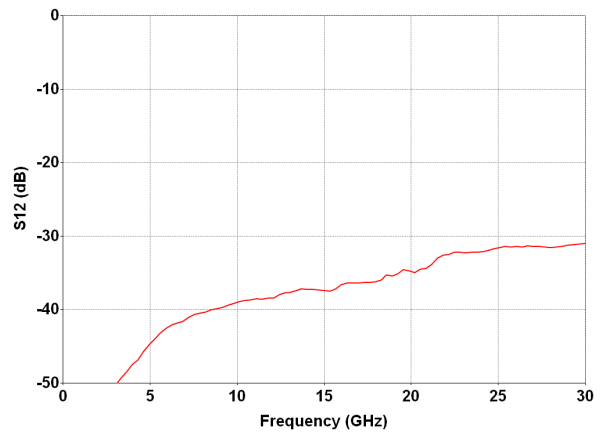
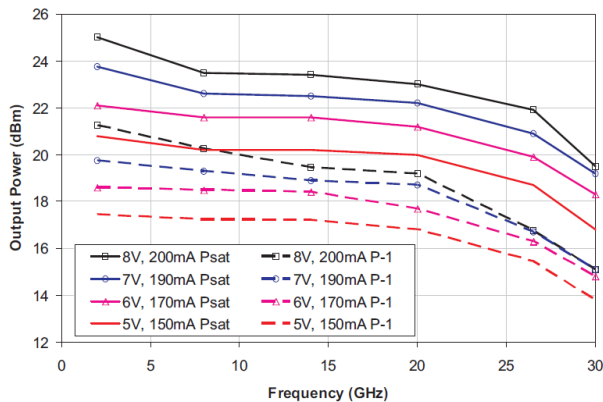
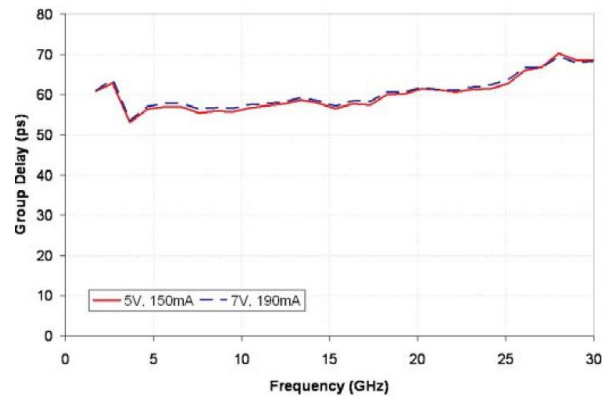
Group Delay

Table 1: Supplemental Specifications

Parameter	Description	Min	Typ	Max
V _{dd}	Drain Bias Voltage	3V	5V	8V
I _{dd}	Drain Bias Current	-	150mA	250mA
V _{g1}	1st Gate Bias Voltage	-2V	-	0V
V _{g2}	2nd Gate Bias Voltage	V _{dd} - V _{g2} < 7V	N/C	+4V
P _{in}	Input Power (CW)	-	-	20dBm
P _{dc}	Power Dissipation	-	0.75W	-
T _{ch}	Channel Temperature	-	-	150°C
Θ _{ch}	Thermal Resistance (T _{case} =85°C)	-	18° C/W	-



Caution, ESD
Sensitive Device

DC Bias:

The MMA022AA is biased by applying a positive voltage to the drain (V_{dd}), then setting the drain current (I_{dd}) using a negative voltage on the gate (V_{g1}).

When zero volts is applied to the gate, the drain to source channel is open; this results in high I_{dd} . When V_{g1} is biased negatively, the channel is pinched off and I_{dd} decreases.

The nominal bias is $V_{dd}=5.0V$, $I_{dd}=150mA$. Improved noise or power performance can be achieved with application-specific biasing.

Gain Control:

Dynamic gain control is available when operating the amplifier in the linear gain region. Negative voltage applied to the second gate (V_{g2}) reduces amplifier gain.

RF Power Detection:

RF output power can be calculated from the difference between the RF detector voltage and the DC detector voltage, minus a DC offset. Please consult the power detector application note available from the Microsemi webpage.

Low-Frequency Use:

The MMA022AA has been designed so that the bandwidth can be extended to low frequencies. The low end corner frequency of the device is primarily determined by the external biasing and AC coupling circuitry.

Matching:

The amplifier incorporates on-chip termination resistors on the RF input and output. These resistors are RF grounded through on-chip capacitors, which are small and become open circuits at frequencies below 1GHz.

A pair of gate and drain termination bypass pads are provided for connecting external capacitors required for the low frequency extension network. These capacitors should be 10x the value of the DC blocking capacitors.

DC Blocks:

The amplifier is DC coupled to the RF input and output pads; DC voltage on these pads must be isolated from external circuitry.

For operation above 2GHz, a series DC-blocking capacitor with minimum value of 20pF is recommended; operation above 40MHz requires a minimum of 120pF.

Bias Inductor:

DC bias applied to the drain (V_{dd}) must be decoupled with an off-chip RF choke inductor. The amount of bias inductance will determine the low frequency operating point. Inductive biasing can also be applied to the chip through the RF output.

For many applications above 2GHz, a bondwire from the V_{dd} pad will suffice as the biasing inductor. Ensure the correct bond length as shown in the assembly diagrams.

Simplified Circuit Schematic

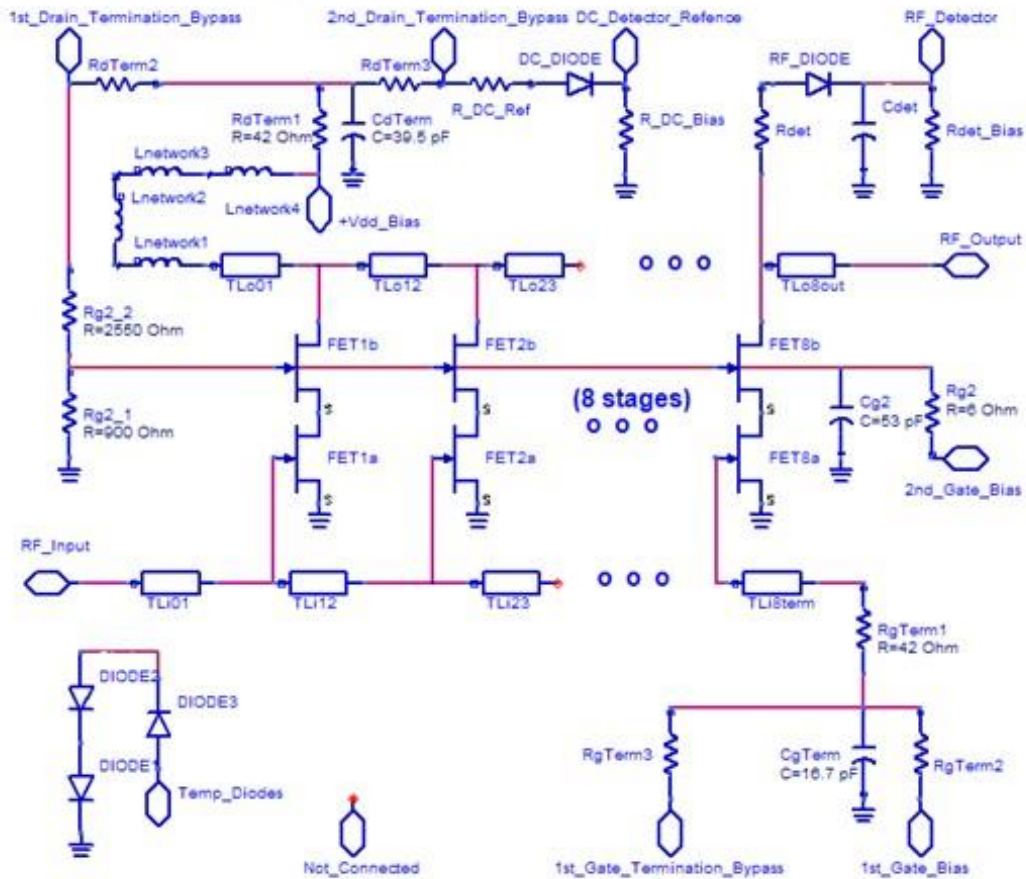

Die size, pad locations, and pad descriptions

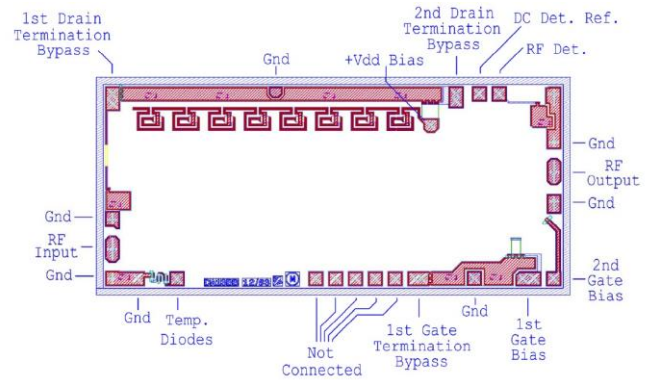
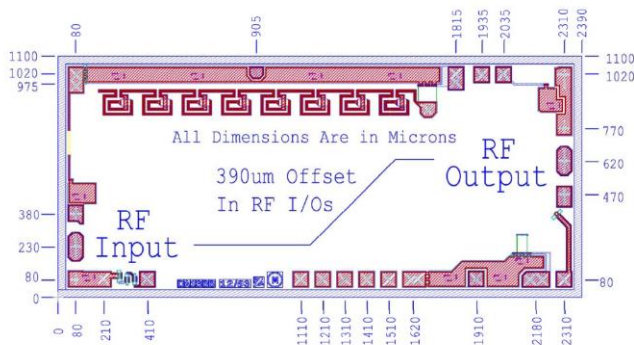

30GHz bonding diagram

30KHz - 30GHz bonding diagram

2GHz-30GHz Bonding Diagram

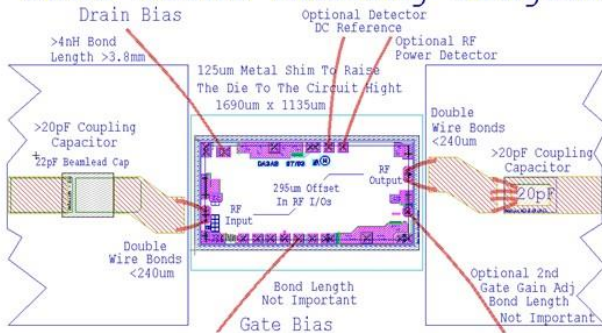

30KHz-30GHz Bonding Diagram

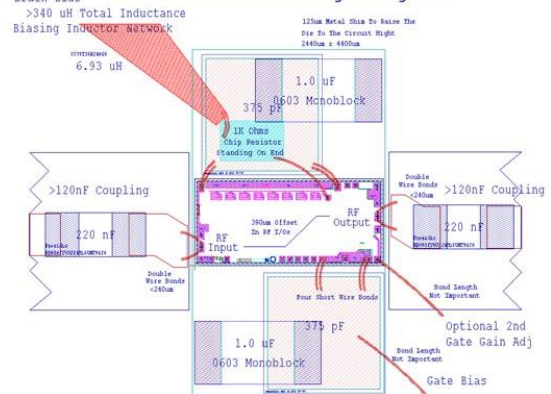

Pick-up and Chip Handling:

This MMIC has exposed air bridges on the top surface. Do not pick up chip with vacuum on the die center; handle from edges or with a custom collet.

Thermal Heat Sinking:

To avoid damage and for optimum performance, you must observe the maximum channel temperature and ensure adequate heat sinking.

ESD Handling and Bonding:

This MMIC is ESD sensitive; preventive measures should be taken during handling, die attach, and bonding.

Epoxy die attach is recommended. Please review our application note MM-APP-0001 handling and die attach recommendations, on our website for more handling, die attach and bonding information.