

N-Channel Switch

J111, J112, J113, MMBFJ111, MMBFJ112, MMBFJ113

Features

- This Device is Designed for Low Level Analog Switching, Sample and Hold Circuits and Chopper Stabilized Amplifiers
- Sourced from Process 51
- Source & Drain are Interchangeable
- These are Pb-Free Devices

ABSOLUTE MAXIMUM RATINGS ($T_A = 25^\circ\text{C}$ unless otherwise noted)
(Note 1, 2)

Symbol	Parameter	Value	Unit
V_{DG}	Drain-Source Voltage	35	V
V_{GS}	Gate-Source Voltage	-35	V
I_{GF}	Forward Gate Current	50	mA
T_J, T_{STG}	Operating and Storage Junction Temperature Range	-55 to 150	$^\circ\text{C}$

Stresses exceeding those listed in the Maximum Ratings table may damage the device. If any of these limits are exceeded, device functionality should not be assumed, damage may occur and reliability may be affected.

1. These ratings are based on a maximum junction temperature of 150°C .
2. These are steady-state limits. ON Semiconductor should be consulted on applications involving pulsed or low-duty-cycle operations.

THERMAL CHARACTERISTICS ($T_A = 25^\circ\text{C}$ unless otherwise noted)

Symbol	Parameter	Max		Unit
		J111 / J112 / J113 (Note 3)	MMBFJ111 / MMBFJ112 / MMBFJ113 (Note 4)	
P_D	Total Device Dissipation	625	350	mW
	Derate Above 25°C	5.0	2.8	mW/ $^\circ\text{C}$
$R_{\theta JC}$	Thermal Resistance, Junction-to-Case	125	-	$^\circ\text{C}/\text{W}$
$R_{\theta JA}$	Thermal Resistance, Junction-to-Ambient	200	357	$^\circ\text{C}/\text{W}$

3. PCB size: FR-4, 76 mm x 114 mm x 1.57 mm (3.0 inch x 4.5 inch x 0.062 inch) with minimum land pattern size.
4. Device mounted on FR-4 PCB 36 mm x 18 mm x 1.5 mm; mounting pad for the collector lead minimum 6 cm^2 .



ON Semiconductor®

www.onsemi.com

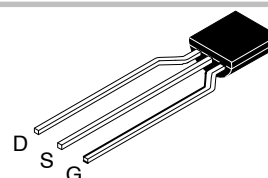

**TO-92 3 4.83x4.76 LEADFORMED
CASE 135AR**

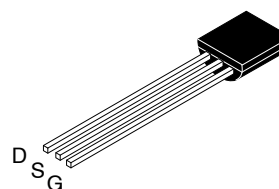

**TO-92 3 4.825x4.76
CASE 135AN**

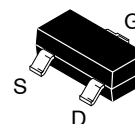

**SOT-23 (TO-236)
CASE 318-08**

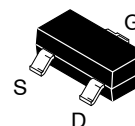

**SOT-23
CASE 318BM**

MARKING DIAGRAMS

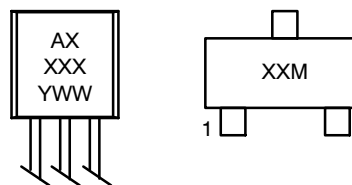

XXXX, XX = Specific Device Code
A = Assembly Plant Code
Y = Year
WW = Work Week
M = Date Code

ORDERING INFORMATION

See detailed ordering and shipping information on page 6 of this data sheet.

J111, J112, J113, MMBFJ111, MMBFJ112, MMBFJ113

ELECTRICAL CHARACTERISTICS (T_J = 25°C unless otherwise noted)

Symbol	Parameter	Test Condition	Min	Max	Unit
--------	-----------	----------------	-----	-----	------

OFF CHARACTERISTICS

V _{(BR)GSS}	Gate-Source Breakdown Voltage	I _G = -1.0 μA, V _{DS} = 0	-35	-	V	
I _{GSS}	Gate Reverse Current	V _{GS} = -15 V, V _{DS} = 0	-	-1.0	nA	
V _{GS(off)}	Gate-Source Cut-Off Voltage	V _{DS} = 5 V, I _D = 1.0 μA	111	-3.0	-10.0	V
			112	-1.0	-5.0	
			113	-0.5	-3.0	
I _{D(off)}	Drain Cutoff Leakage Current	V _{DS} = 5.0 V, V _{GS} = -10 V	-	1.0	nA	

ON CHARACTERISTICS

I _{DSS}	Zero-Gate Voltage Drain Current (Note 5)	V _{DS} = 15 V, V _{GS} = 0	111	20	-	mA
			112	5.0	-	
			113	2.0	-	
r _{DS(on)}	Drain-Source On Resistance	V _{DS} ≤ 0.1 V, V _{GS} = 0	111	-	30	Ω
			112	-	50	
			113	-	100	

SMALL SIGNAL CHARACTERISTICS

C _{dg(on)} C _{sg(on)}	Drain-Gate & Source-Gate On Capacitance	V _{DS} = 0, V _{GS} = 0, f = 1.0 MHz	-	28	pF
C _{dg(off)}	Drain-Gate Off Capacitance	V _{DS} = 0, V _{GS} = -10 V, f = 1.0 MHz	-	5.0	pF
C _{sg(off)}	Source-Gate Off Capacitance	V _{DS} = 0, V _{GS} = -10 V, f = 1.0 MHz	-	5.0	pF

Product parametric performance is indicated in the Electrical Characteristics for the listed test conditions, unless otherwise noted. Product performance may not be indicated by the Electrical Characteristics if operated under different conditions.

5. Pulse test: pulse width ≤ 300 μs, duty cycle ≤ 2%.

TYPICAL PERFORMANCE CHARACTERISTICS

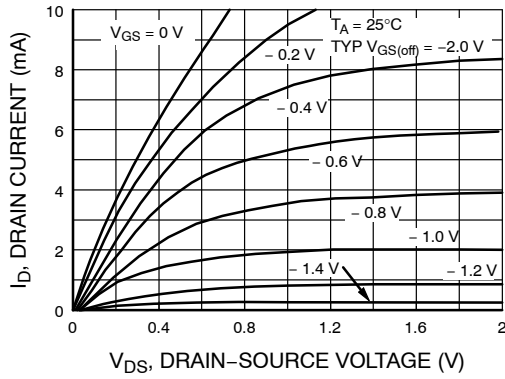

Figure 1. Common Drain-Source



Figure 2. Parameter Interactions



Figure 3. Transfer Characteristics



Figure 4. Transfer Characteristics

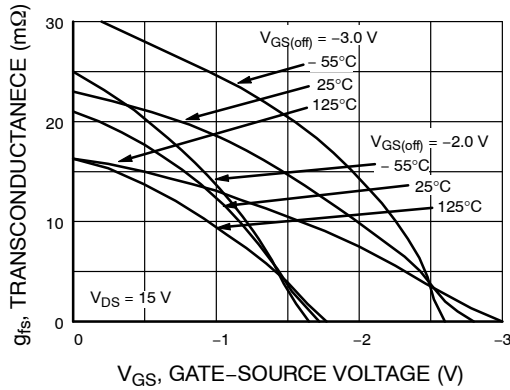

Figure 5. Transfer Characteristics



Figure 6. Transfer Characteristics

TYPICAL PERFORMANCE CHARACTERISTICS (Continued)



Figure 7. On Resistance vs. Drain Current

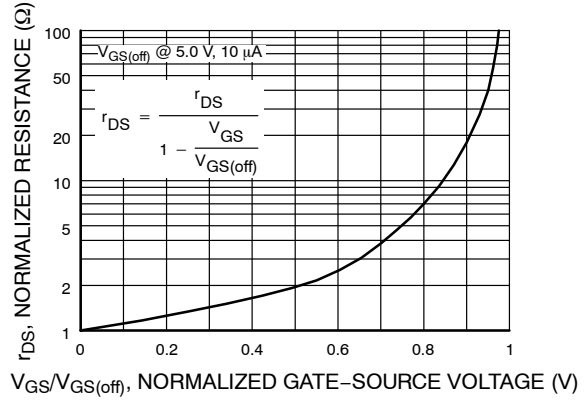

Figure 8. Normalized Drain Resistance vs. Bias Voltage

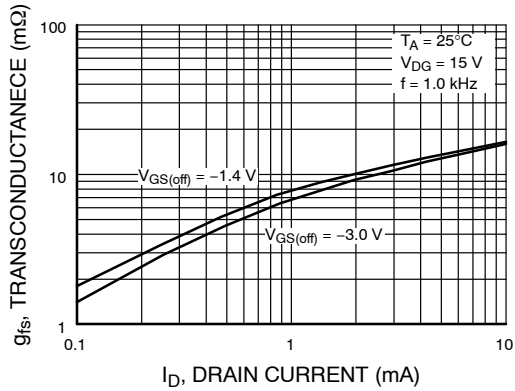

Figure 9. Transconductance vs. Drain Current

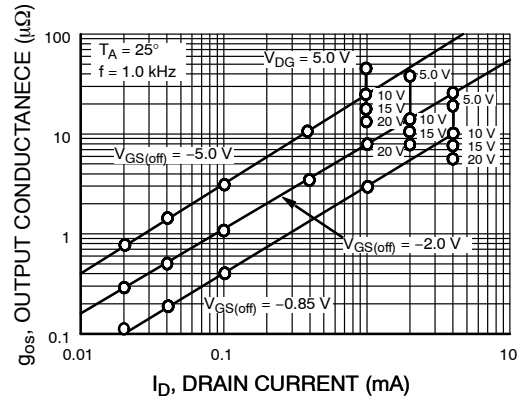

Figure 10. Output Conductance vs. Drain Current



Figure 11. Capacitance vs. Voltage



Figure 12. Noise Voltage vs. Frequency

TYPICAL PERFORMANCE CHARACTERISTICS (Continued)

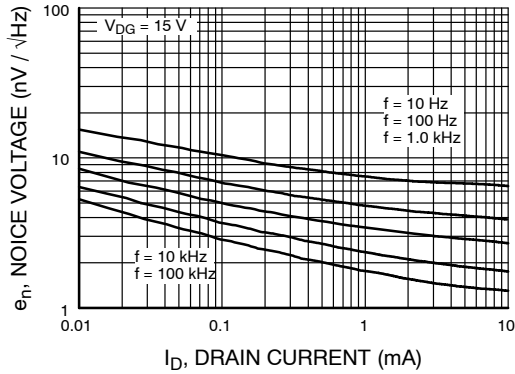

Figure 13. Noise Voltage vs. Current

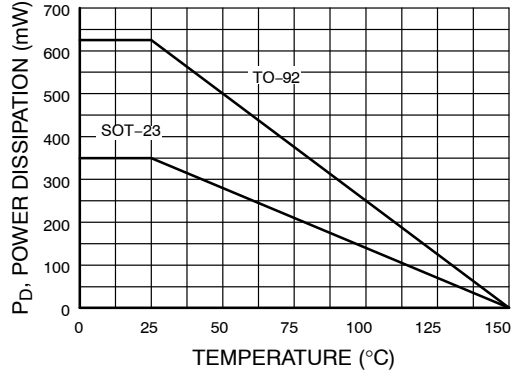

Figure 14. Power Dissipation vs. Ambient Temperature

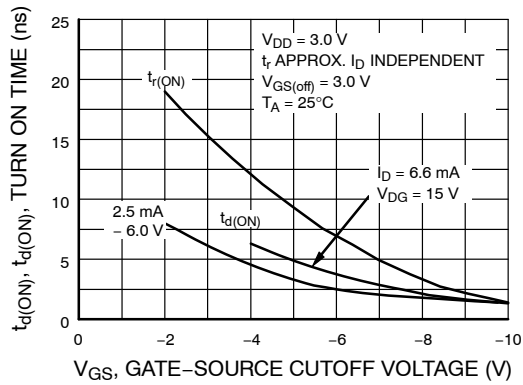

Figure 15. Switching Turn-On Time vs. Gate-Source Voltage

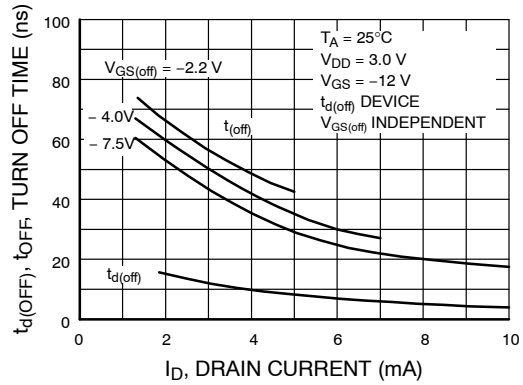

Figure 16. Switching Turn-Off Time vs. Drain Current

J111, J112, J113, MMBFJ111, MMBFJ112, MMBFJ113

ORDERING INFORMATION

Part Number	Top Mark	Package	Shipping [†]
J111	AJ 111 YWW	TO-92 3L (Pb-Free)	10000 Units / Bulk
J111-D26Z	AJ 111 YWW	TO-92 3L (Pb-Free)	2000 / Tape & Reel
J111-D74Z	AJ 111 YWW	TO-92 3L (Pb-Free)	2000 / Ammo
J112	AJ 112 YWW	TO-92 3L (Pb-Free)	10000 Units / Bulk
J112-D26Z	AJ 112 YWW	TO-92 3L (Pb-Free)	2000 / Tape & Reel
J112-D27Z	AJ 112 YWW	TO-92 3L (Pb-Free)	2000 / Tape & Reel
J112-D74Z	AJ 112 YWW	TO-92 3L (Pb-Free)	2000 / Ammo
J113	AJ 113 YWW	TO-92 3L (Pb-Free)	10000 Units / Bulk
J113-D74Z	AJ 113 YWW	TO-92 3L (Pb-Free)	2000 / Ammo
MMBFJ111	6P	SOT-23 3L (Pb-Free)	3000 / Tape & Reel
MMBFJ112	6R	SOT-23 3L (Pb-Free)	3000 / Tape & Reel
MMBFJ113	6S	SOT-23 3L (Pb-Free)	3000 / Tape & Reel

†For information on tape and reel specifications, including part orientation and tape sizes, please refer to our Tape and Reel Packaging Specifications Brochure, BRD8011/D.

MECHANICAL CASE OUTLINE
PACKAGE DIMENSIONS

TO-92 3 4.825x4.76
CASE 135AN
ISSUE O

DATE 31 JUL 2016



NOTES: UNLESS OTHERWISE SPECIFIED

- A) DRAWING WITH REFERENCE TO JEDEC TO-92 RECOMMENDATIONS.
- B) ALL DIMENSIONS ARE IN MILLIMETERS.
- C) DRAWING CONFORMS TO ASME Y14.5M-2009.

DOCUMENT NUMBER:	98AON13880G	Electronic versions are uncontrolled except when accessed directly from the Document Repository. Printed versions are uncontrolled except when stamped "CONTROLLED COPY" in red.
DESCRIPTION:	TO-92 3 4.825X4.76	PAGE 1 OF 1

ON Semiconductor and **ON** are trademarks of Semiconductor Components Industries, LLC dba ON Semiconductor or its subsidiaries in the United States and/or other countries. ON Semiconductor reserves the right to make changes without further notice to any products herein. ON Semiconductor makes no warranty, representation or guarantee regarding the suitability of its products for any particular purpose, nor does ON Semiconductor assume any liability arising out of the application or use of any product or circuit, and specifically disclaims any and all liability, including without limitation special, consequential or incidental damages. ON Semiconductor does not convey any license under its patent rights nor the rights of others.

TO-92 3 4.83x4.76 LEADFORMED
CASE 135AR
ISSUE O

DATE 30 SEP 2016



NOTES: UNLESS OTHERWISE SPECIFIED

- A) DRAWING WITH REFERENCE TO JEDEC TO-92 RECOMMENDATIONS.
- B) ALL DIMENSIONS ARE IN MILLIMETERS.
- C) DRAWING CONFORMS TO ASME Y14.5M-1994

DOCUMENT NUMBER:	98AON13879G	Electronic versions are uncontrolled except when accessed directly from the Document Repository. Printed versions are uncontrolled except when stamped "CONTROLLED COPY" in red.
DESCRIPTION:	TO-92 3 4.83X4.76 LEADFORMED	PAGE 1 OF 1

ON Semiconductor and  are trademarks of Semiconductor Components Industries, LLC dba ON Semiconductor or its subsidiaries in the United States and/or other countries. ON Semiconductor reserves the right to make changes without further notice to any products herein. ON Semiconductor makes no warranty, representation or guarantee regarding the suitability of its products for any particular purpose, nor does ON Semiconductor assume any liability arising out of the application or use of any product or circuit, and specifically disclaims any and all liability, including without limitation special, consequential or incidental damages. ON Semiconductor does not convey any license under its patent rights nor the rights of others.

MECHANICAL CASE OUTLINE

PACKAGE DIMENSIONS

ON Semiconductor®



SOT-23 (TO-236) CASE 318-08 ISSUE AS

DATE 30 JAN 2018

SCALE 4:1



NOTES:

1. DIMENSIONING AND TOLERANCING PER ASME Y14.5M, 1994.
2. CONTROLLING DIMENSION: MILLIMETERS.
3. MAXIMUM LEAD THICKNESS INCLUDES LEAD FINISH. MINIMUM LEAD THICKNESS IS THE MINIMUM THICKNESS OF THE BASE MATERIAL.
4. DIMENSIONS D AND E DO NOT INCLUDE MOLD FLASH, PROTRUSIONS, OR GATE BURRS.

DIM	MILLIMETERS			INCHES		
	MIN	NOM	MAX	MIN	NOM	MAX
A	0.89	1.00	1.11	0.035	0.039	0.044
A1	0.01	0.06	0.10	0.000	0.002	0.004
b	0.37	0.44	0.50	0.015	0.017	0.020
c	0.08	0.14	0.20	0.003	0.006	0.008
D	2.80	2.90	3.04	0.110	0.114	0.120
E	1.20	1.30	1.40	0.047	0.051	0.055
e	1.78	1.90	2.04	0.070	0.075	0.080
L	0.30	0.43	0.55	0.012	0.017	0.022
L1	0.35	0.54	0.69	0.014	0.021	0.027
HE	2.10	2.40	2.64	0.083	0.094	0.104
T	0°	---	10°	0°	---	10°

RECOMMENDED SOLDERING FOOTPRINT



GENERIC MARKING DIAGRAM*

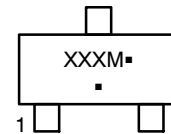

XXX = Specific Device Code
M = Date Code
▪ = Pb-Free Package

*This information is generic. Please refer to device data sheet for actual part marking. Pb-Free indicator, "G" or microdot "▪", may or may not be present.

STYLE 1 THRU 5:
CANCELLED

STYLE 6:
PIN 1. BASE
2. EMITTER
3. COLLECTOR

STYLE 7:
PIN 1. EMITTER
2. BASE
3. COLLECTOR

STYLE 8:
PIN 1. ANODE
2. NO CONNECTION
3. CATHODE

STYLE 9:
PIN 1. ANODE
2. ANODE
3. CATHODE

STYLE 10:
PIN 1. DRAIN
2. SOURCE
3. GATE

STYLE 11:
PIN 1. ANODE
2. CATHODE
3. CATHODE-ANODE

STYLE 12:
PIN 1. CATHODE
2. CATHODE
3. ANODE

STYLE 13:
PIN 1. SOURCE
2. DRAIN
3. GATE

STYLE 14:
PIN 1. CATHODE
2. GATE
3. ANODE

STYLE 15:
PIN 1. GATE
2. CATHODE
3. ANODE

STYLE 16:
PIN 1. ANODE
2. CATHODE
3. CATHODE

STYLE 17:
PIN 1. NO CONNECTION
2. ANODE
3. CATHODE

STYLE 18:
PIN 1. NO CONNECTION
2. CATHODE
3. ANODE

STYLE 19:
PIN 1. CATHODE
2. ANODE
3. CATHODE-ANODE

STYLE 20:
PIN 1. CATHODE
2. ANODE
3. GATE

STYLE 21:
PIN 1. GATE
2. SOURCE
3. DRAIN

STYLE 22:
PIN 1. RETURN
2. OUTPUT
3. INPUT

STYLE 23:
PIN 1. ANODE
2. ANODE
3. CATHODE

STYLE 24:
PIN 1. GATE
2. DRAIN
3. SOURCE

STYLE 25:
PIN 1. ANODE
2. CATHODE
3. GATE

STYLE 26:
PIN 1. CATHODE
2. ANODE
3. NO CONNECTION

STYLE 27:
PIN 1. CATHODE
2. CATHODE
3. CATHODE

STYLE 28:
PIN 1. ANODE
2. ANODE
3. ANODE

DOCUMENT NUMBER:	98ASB42226B	Electronic versions are uncontrolled except when accessed directly from the Document Repository. Printed versions are uncontrolled except when stamped "CONTROLLED COPY" in red.
DESCRIPTION:	SOT-23 (TO-236)	PAGE 1 OF 1

ON Semiconductor and are trademarks of Semiconductor Components Industries, LLC dba ON Semiconductor or its subsidiaries in the United States and/or other countries. ON Semiconductor reserves the right to make changes without further notice to any products herein. ON Semiconductor makes no warranty, representation or guarantee regarding the suitability of its products for any particular purpose, nor does ON Semiconductor assume any liability arising out of the application or use of any product or circuit, and specifically disclaims any and all liability, including without limitation special, consequential or incidental damages. ON Semiconductor does not convey any license under its patent rights nor the rights of others.

MECHANICAL CASE OUTLINE PACKAGE DIMENSIONS

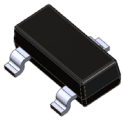

SOT-23
CASE 318BM
ISSUE A

DATE 01 SEP 2021

NOTES: UNLESS OTHERWISE SPECIFIED

- A) REFERENCE JEDEC REGISTRATION TO-236, VARIATION AB, ISSUE H.
- B) ALL DIMENSIONS ARE IN MILLIMETERS.
- C) DIMENSIONS ARE INCLUSIVE OF BURRS, MOLD FLASH AND TIE BAR EXTRUSIONS.
- D) DIMENSIONING AND TOLERANCING PER ASME Y14.5M - 2009.

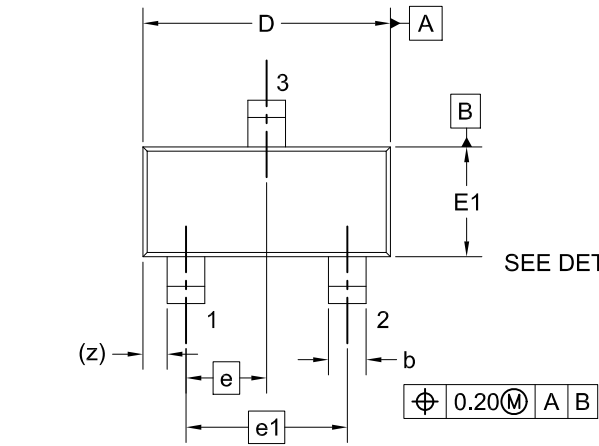

SEE DETAIL A

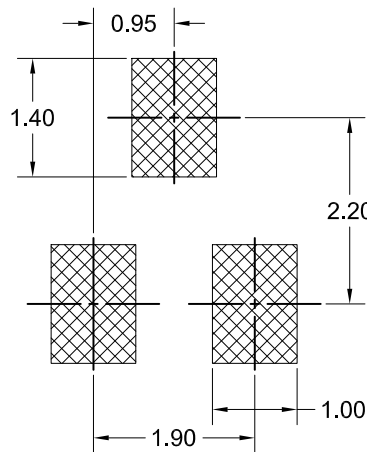
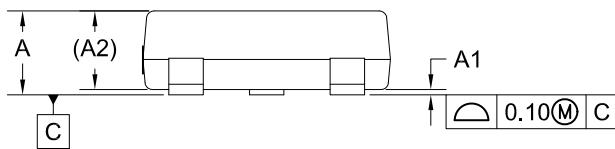
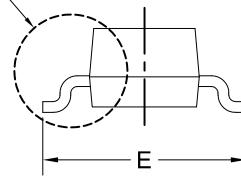

DIM	MILLIMETERS		
	MIN.	NOM.	MAX.
A	---	---	1.20
A1	0.00	0.05	0.10
A2	0.93 REF		
b	0.37	0.44	0.60
c	0.08	0.15	0.23
D	2.72	2.92	3.12
E	2.10	2.40	2.70
E1	1.15	1.30	1.50
e	0.95 BSC		
e1	1.90 BSC		
L	0.20	---	---
L1	0.55 REF		
z	0.29 REF		

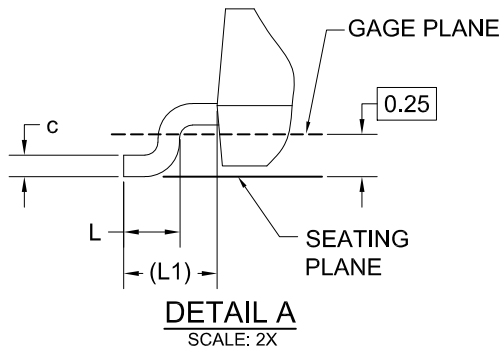

LAND PATTERN
RECOMMENDATION

*FOR ADDITIONAL INFORMATION ON OUR PB-FREE STRATEGY AND SOLDERING DETAILS, PLEASE DOWNLOAD THE ON SEMICONDUCTOR SOLDERING AND MOUNTING TECHNIQUES REFERENCE MANUAL, SOLDERRM/D.

GENERIC MARKING DIAGRAM*

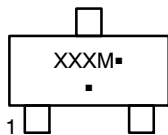

- XXX = Specific Device Code
- M = Date Code
- = Pb-Free Package

*This information is generic. Please refer to device data sheet for actual part marking. Pb-Free indicator, "G" or microdot "▪", may or may not be present. Some products may not follow the Generic Marking.

DOCUMENT NUMBER:	98AON13784G	Electronic versions are uncontrolled except when accessed directly from the Document Repository. Printed versions are uncontrolled except when stamped "CONTROLLED COPY" in red.
DESCRIPTION:	SOT-23	PAGE 1 OF 1

onsemi and ONSEMI are trademarks of Semiconductor Components Industries, LLC dba onsemi or its subsidiaries in the United States and/or other countries. onsemi reserves the right to make changes without further notice to any products herein. onsemi makes no warranty, representation or guarantee regarding the suitability of its products for any particular purpose, nor does onsemi assume any liability arising out of the application or use of any product or circuit, and specifically disclaims any and all liability, including without limitation special, consequential or incidental damages. onsemi does not convey any license under its patent rights nor the rights of others.