



# MMBT2222A

## NPN GENERAL PURPOSE SWITCHING TRANSISTOR

**VOLTAGE** 40 Volt    **POWER** 225 mWatt

**SOT-23**    Unit : inch(mm)

### FEATURES

- NPN epitaxial silicon, planar design
- Collector-emitter voltage VCE = 40V
- Collector current IC = 600mA
- Lead free in compliance with EU RoHS 2.0
- Green molding compound as per IEC 61249 standard

### MECHANICAL DATA

Case: SOT-23, Plastic

Terminals: Solderable per MIL-STD-750, Method 2026

Approx. Weight: 0.0003 ounces, 0.0084 grams

Marking: M2A

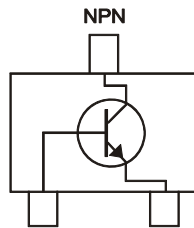
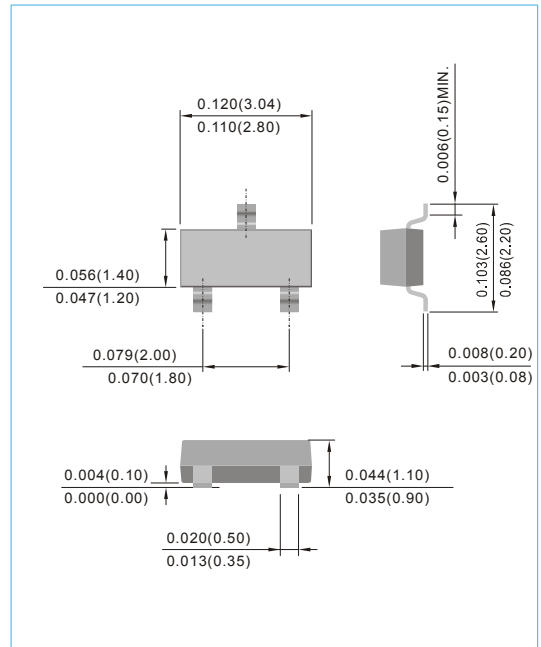

Fig.34(TOP VIEW)



### ABSOLUTE RATINGS

Parameter	Symbol	Value	Units
Collector - Emitter Voltage	V <sub>CEO</sub>	40	V
Collector - Base Voltage	V <sub>CBO</sub>	75	V
Emitter - Base Voltage	V <sub>EB0</sub>	6	V
Collector Current - Continuous	I <sub>c</sub>	600	mA

### THERMAL CHARACTERISTICS

Parameter	Symbol	Value	Units
Max. Power Dissipation (Note 1)	P <sub>TOT</sub>	225	mW
Thermal Resistance , Junction to Ambient	R <sub>θJA</sub>	556	°C/W
Junction Temperature	T <sub>J</sub>	-55 to +150	°C
Storage Temperature	T <sub>STG</sub>	-55 to +150	°C

Note 1 : Transistor mounted on FR-5 board 1 x 0.75 x 0.062 in.



# MMBT2222A

## ELECTRICAL CHARACTERISTICS

PARAMETER	Symbol	Test Condition	MIN.	TYP.	MAX.	Units
Collector - Emitter Breakdown Voltage	$V_{(BR)CEO}$	$I_C=1.0mA, I_B=0$	40	-	-	V
Collector - Base Breakdown Voltage	$V_{(BR)CBO}$	$I_C=10\mu A, I_E=0$	75	-	-	V
Emitter - Base Breakdown Voltage	$V_{(BR)EBO}$	$I_E=10\mu A, I_C=0$	6.0	-	-	V
Base Cutoff Current	$I_{BL}$	$V_{CE}=60V, V_{EB}=3.0V$	-	-	20	nA
Collector Cutoff Current	$I_{CEX}$	$V_{CE}=60V, V_{EB}=3.0V$	-	-	10	nA
	$I_{CBO}$	$V_{CE}=60V, I_E=0, V_{CE}=60V, I_E=0, T_J=125^\circ C$	-	-	10 10	nA uA
Emitter Cutoff Current	$I_{EBO}$	$V_{EB}=3.0V, I_C=0,$	-	-	100	nA
DC Current Gain	$h_{FE}$	$I_C=0.1mA, V_{CE}=10V$	35	-	-	-
		$I_C=1.0mA, V_{CE}=10V$	50	-	-	-
		$I_C=10mA, V_{CE}=10V$	75	-	-	-
		$I_C=10mA, V_{CE}=10V, T_J=125^\circ C$	35	-	-	-
		$I_C=150mA, V_{CE}=10V$ (Note 2)	100	-	300	-
		$I_C=150mA, V_{CE}=1V$ (Note 2)	50	-	-	-
Collector - Emitter Saturation Voltage (Note 2)	$V_{CE(SAT)}$	$I_C=150mA, I_B=15mA$	-	-	0.3	V
		$I_C=500mA, I_B=50mA$	-	-	1.0	V
Base - Emitter Saturation Voltage (Note 2)	$V_{BE(SAT)}$	$I_C=150mA, I_B=15mA$	0.6	-	1.2	V
		$I_C=500mA, I_B=50mA$	-	-	2.0	V
Collector - Base Capacitance	$C_{CBO}$	$V_{CB}=10V, I_E=0, f=1MHz$	-	-	8.0	pF
Emitter - Base Capacitance	$C_{EBO}$	$V_{CB}=0.5V, I_C=0, f=1MHz$	-	-	25	pF
Delay Time	$t_d$	$V_{CC}=3V, V_{BE}=-5V, I_C=150mA, I_B=15mA$	-	-	10	ns
Rise Time	$t_r$	$V_{CC}=3V, V_{BE}=-5V, I_C=150mA, I_B=15mA$	-	-	25	ns
Storage Time	$t_s$	$V_{CC}=30V, I_C=150mA, I_B1=I_B2=15mA$	-	-	225	ns
Fall Time	$t_f$	$V_{CC}=30V, I_C=150mA, I_B1=I_B2=15mA$	-	-	60	ns

Note 2: Pulse Test: Pulse Width  $\leq 300 \mu s$ , Duty Cycle  $\leq 2.0\%$ .

### SWITCHING TIME EQUIVALENT TEST CIRCUITS

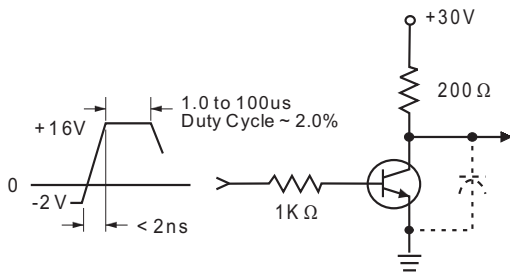

Fig. 1 Turn-On Time

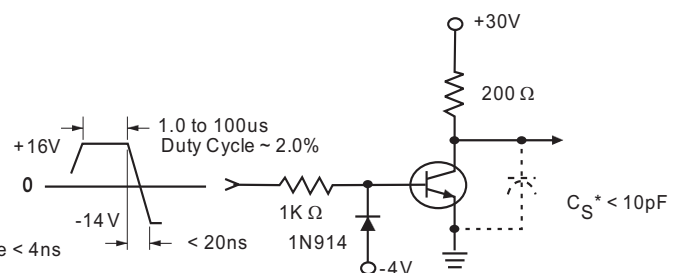
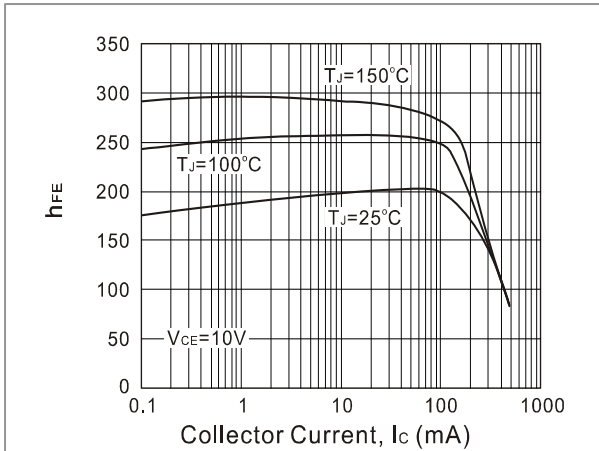

Fig. 2 Turn-Off Time

\* Total shunt capacitance of test jig, connectors, and oscilloscope



# MMBT2222A



**Fig. 3. Typical  $h_{FE}$  vs Collector Current**

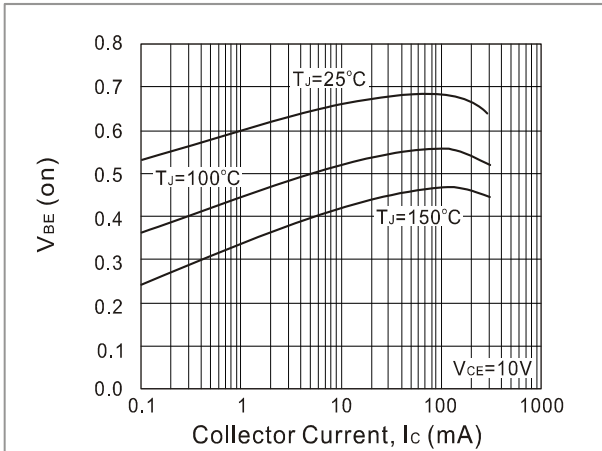

**Fig. 4. Typical  $V_{BE}$  vs Collector Current**

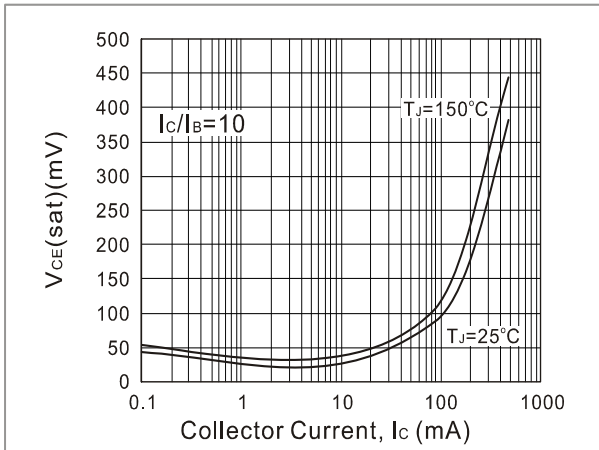

**Fig. 5. Typical  $V_{CE}$  (sat) vs Collector Current**

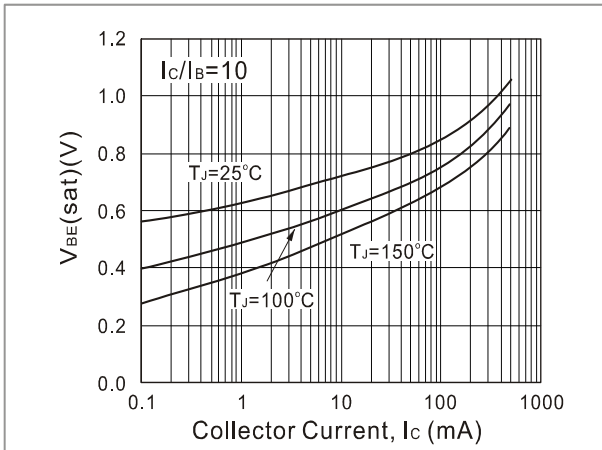

**Fig. 6. Typical  $V_{BE}$  (sat) vs Collector Current**

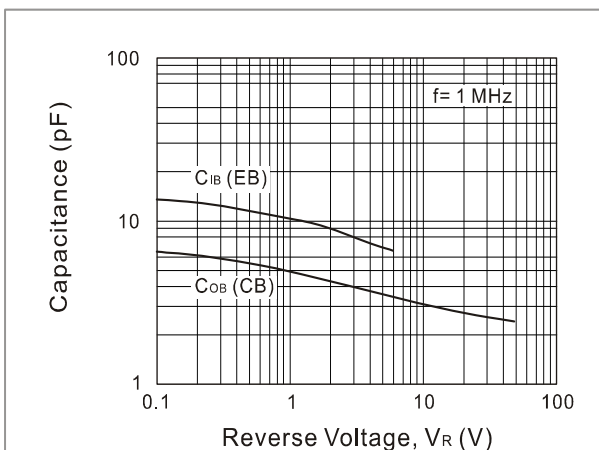

**Fig. 7. Typical Capacitances vs Reverse Voltage**

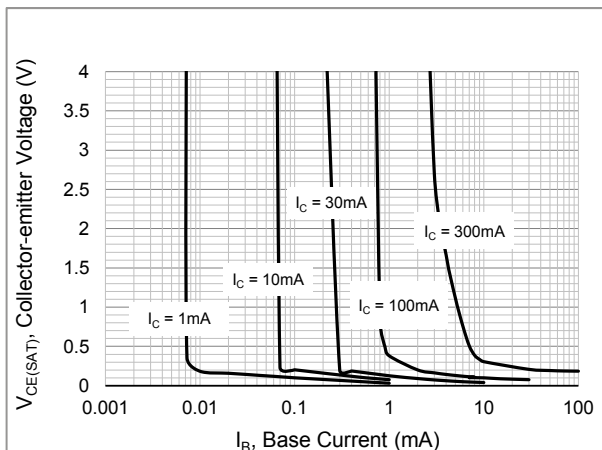

**Fig. 8. Typical Collector Saturation Region**



# MMBT2222A

## MOUNTING PAD LAYOUT

SOT-23

Unit : inch(mm)

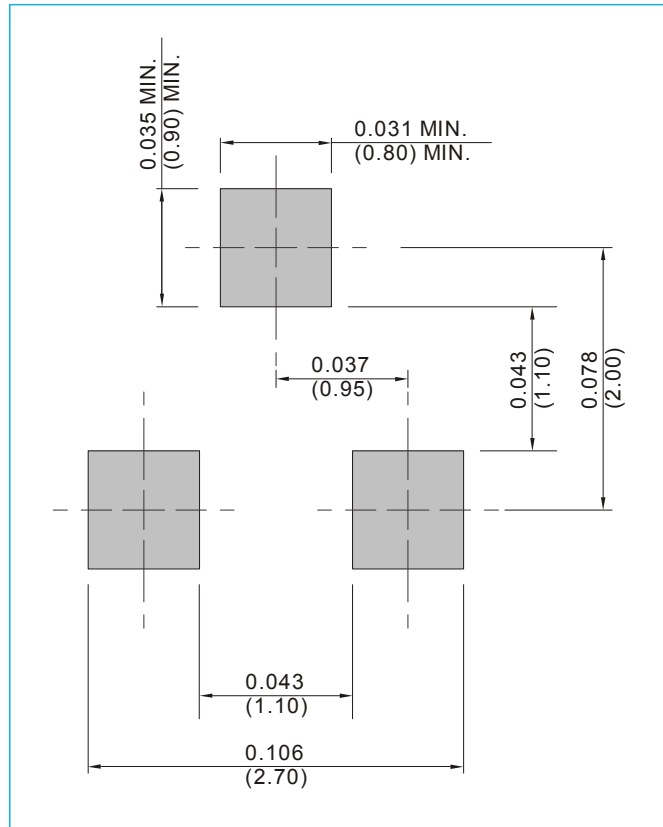

## ORDER INFORMATION

- Packing information  
T/R - 12K per 13" plastic Reel  
T/R - 3K per 7" plastic Reel



# MMBT2222A

## Part No\_packing code\_Version

MMBT2222A\_R1\_00001

MMBT2222A\_R2\_00001

For example :

**RB500V-40\_R2\_00001**

Part No.

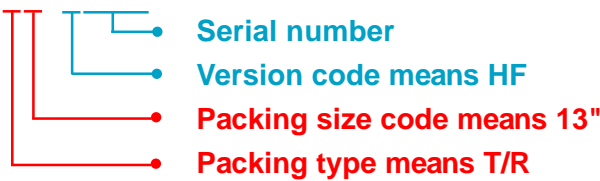

Packing Code <b>XX</b>				Version Code <b>XXXXX</b>		
Packing type	1 <sup>st</sup> Code	Packing size code	2 <sup>nd</sup> Code	HF or RoHS	1 <sup>st</sup> Code	2 <sup>nd</sup> ~5 <sup>th</sup> Code
Tape and Ammunition Box (T/B)	<b>A</b>	N/A	<b>0</b>	<b>HF</b>	<b>0</b>	serial number
Tape and Reel (T/R)	<b>R</b>	7"	<b>1</b>	<b>RoHS</b>	<b>1</b>	serial number
Bulk Packing (B/P)	<b>B</b>	13"	<b>2</b>			
Tube Packing (T/P)	<b>T</b>	26mm	<b>X</b>			
Tape and Reel (Right Oriented) (TRR)	<b>S</b>	52mm	<b>Y</b>			
Tape and Reel (Left Oriented) (TRL)	<b>L</b>	PANASERT T/B CATHODE UP (PBCU)	<b>U</b>			
FORMING	<b>F</b>	PANASERT T/B CATHODE DOWN (PBCD)	<b>D</b>			