

## MMBT4403-HF (PNP)

RoHS Device

Halogen Free

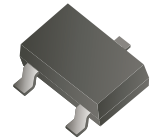

### Features

- Power dissipation of 300mW.
- High stability and high reliability.

### Mechanical data

- Case: SOT-23, molded plastic.
- Epoxy UL: 94V-0.
- Mounting position: Any.

### Circuit Diagram

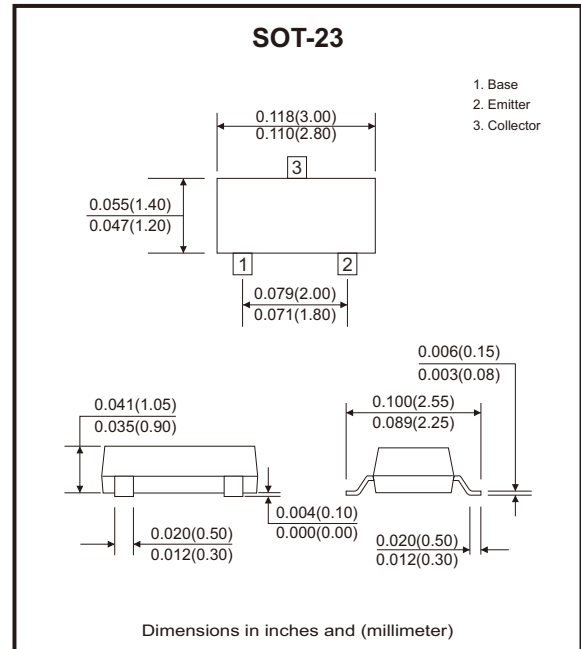
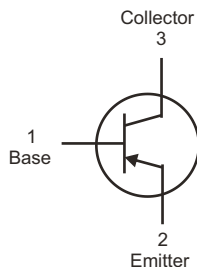

### Maximum Ratings (at TA=25°C unless otherwise noted)

Parameter	Symbol	Value	Unit
Collector-base voltage	V <sub>CB0</sub>	-40	V
Collector-emitter voltage	V <sub>CE0</sub>	-40	V
Emitter-base voltage	V <sub>EB0</sub>	-5	V
Collector current-continuous	I <sub>c</sub>	-600	mA
Collector power dissipation	P <sub>c</sub>	300	mW
Junction temperature	T <sub>J</sub>	150	°C
Storage temperature range	T <sub>STG</sub>	-55 to +150	°C
Thermal resistance from junction to ambient	R <sub>θJA</sub>	417	°C/W

## Electrical Characteristics (at TA=25°C unless otherwise noted)

Parameter	Symbol	Conditions	Min.	Typ.	Max.	Unit
Collector-base breakdown voltage	$V_{(BR)CBO}$	$I_C = -100\mu A, I_E = 0$	-40			V
Collector-emitter breakdown voltage	$V_{(BR)CEO}$	$I_C = -1mA, I_B = 0$	-40			V
Emitter-base breakdown voltage	$V_{(BR)EBO}$	$I_E = -100\mu A, I_C = 0$	-5			V
Collector cut-off current	$I_{CBO}$	$V_{CB} = -35V, I_E = 0$			-100	nA
Collector cut-off current	$I_{CEX}$	$V_{CE} = -35V, V_{EB(off)} = -0.4V$			-100	nA
Emitter cut-off current	$I_{EBO}$	$V_{EB} = -4V, I_C = 0$			-100	nA
DC current gain	$h_{FE1}$	$V_{CE} = -1V, I_C = -0.1mA$	30			
	$h_{FE2}$	$V_{CE} = -1V, I_C = -1mA$	60			
	$h_{FE3}$	$V_{CE} = -1V, I_C = -10mA$	100			
	$h_{FE4}$	$V_{CE} = -2V, I_C = -150mA$	100		300	
	$h_{FE5}$	$V_{CE} = -2V, I_C = -500mA$	20			
Collector-emitter saturation voltage	$V_{CE(sat)}$	$I_C = -150mA, I_B = -15mA$			-0.40	V
		$I_C = -500mA, I_B = -50mA$			-0.75	V
Base-emitter saturation voltage	$V_{BE(sat)}$	$I_C = -150mA, I_B = -15mA$			-0.95	V
		$I_C = -500mA, I_B = -50mA$			-1.30	V
Transition frequency	$f_T$	$V_{CE} = -10V, I_C = -20mA, f = 100MHz$	200			MHz
Delay time	$t_d$	$V_{CC} = -30V, V_{BE(off)} = -0.5V, I_C = -150mA, I_{B1} = -15mA$			15	ns
Rise time	$t_r$				20	ns
Storage time	$t_s$	$V_{CC} = -30V, I_C = -150mA, I_{B1} = I_{B2} = -15mA$			225	ns
Fall time	$t_f$				60	ns

## Rating and Characteristic Curves (MMBT4403-HF)

Fig.1 - Static Characteristic

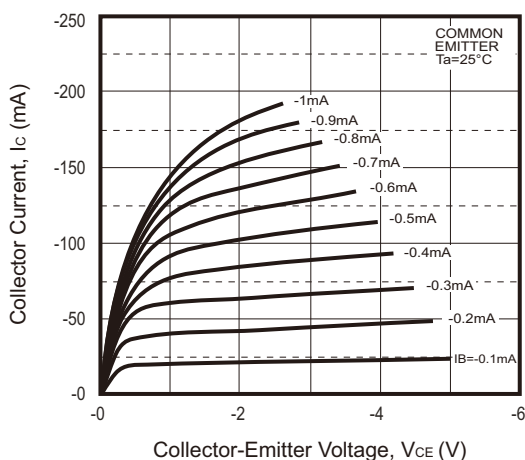
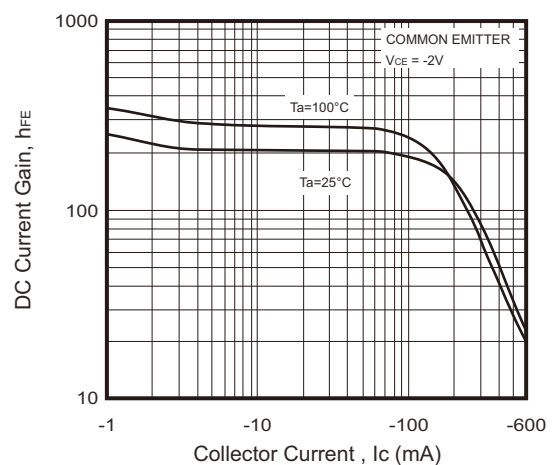

Fig.2 -  $h_{FE} - I_C$



Company reserves the right to improve product design, functions and reliability without notice.

REV:A

## Rating and Characteristic Curves (MMBT4403-HF)

Fig.3 -  $V_{CEsat} - I_c$

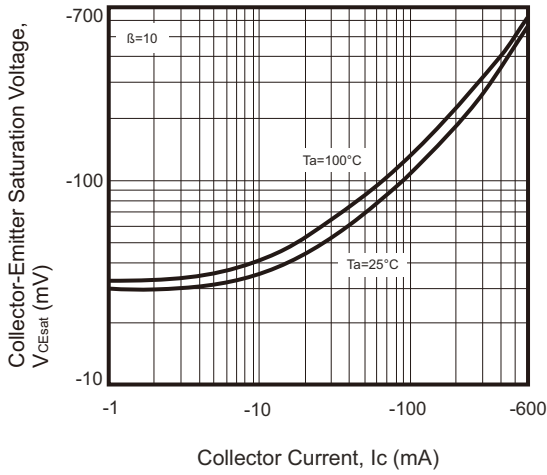

Fig.4 -  $V_{BEsat} - I_c$

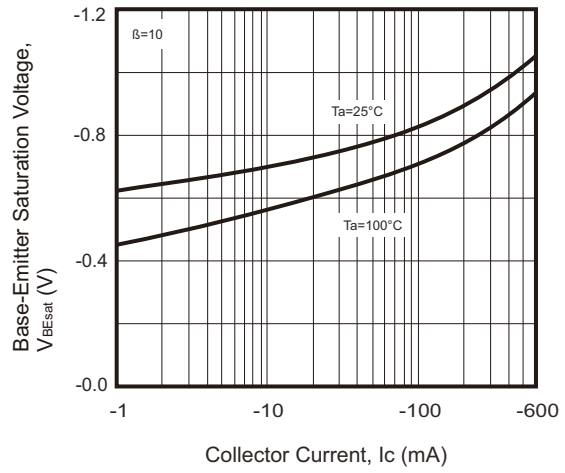

Fig.5 -  $I_c - V_{BE}$

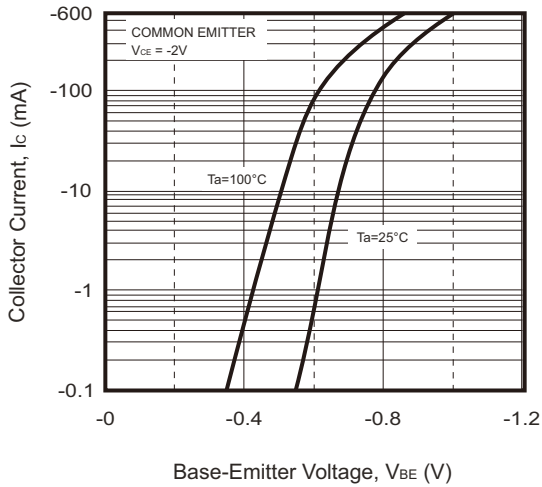

Fig.6 -  $C_{ob}/C_{ib} - V_{CB}/V_{EB}$

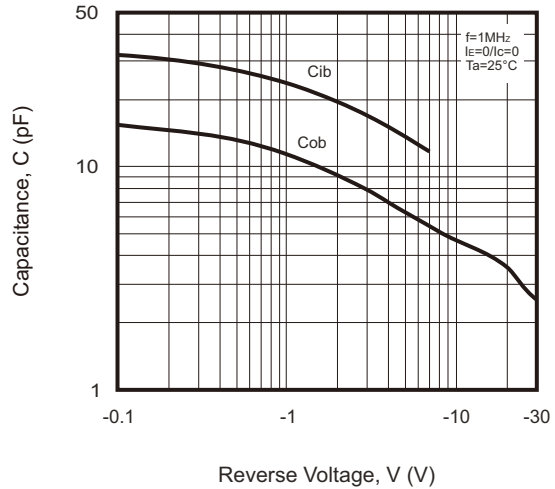

Fig.7 -  $f_T - I_c$

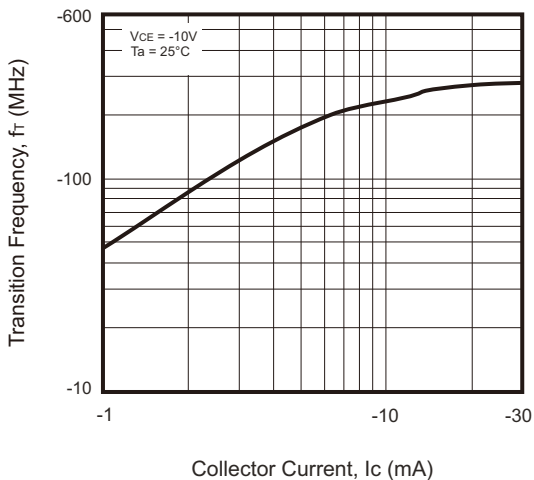
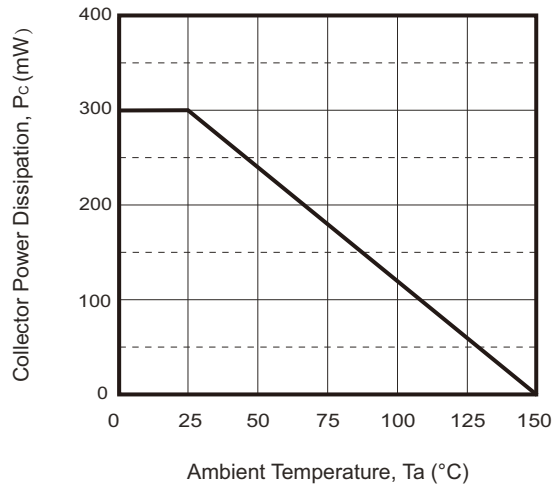
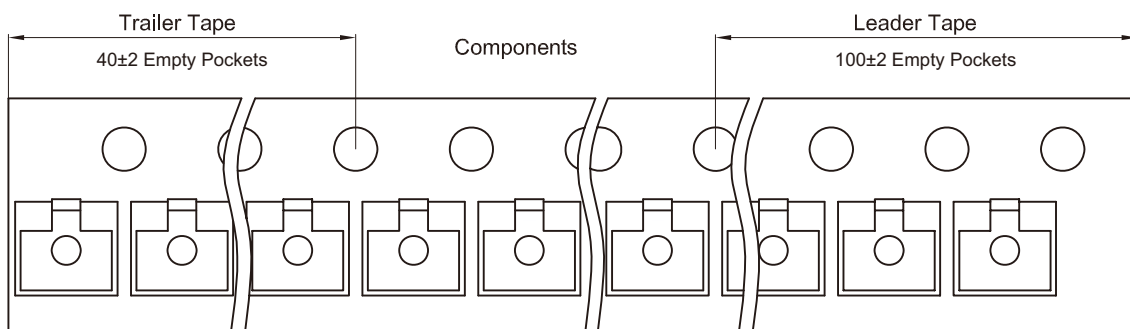
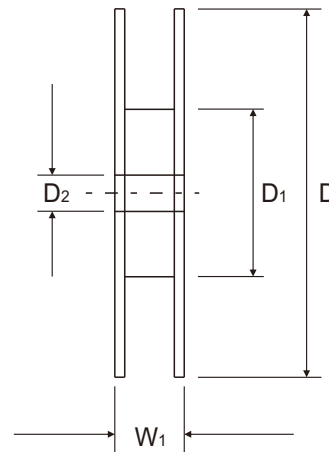
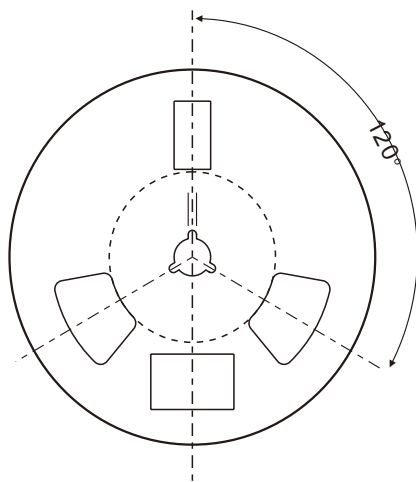
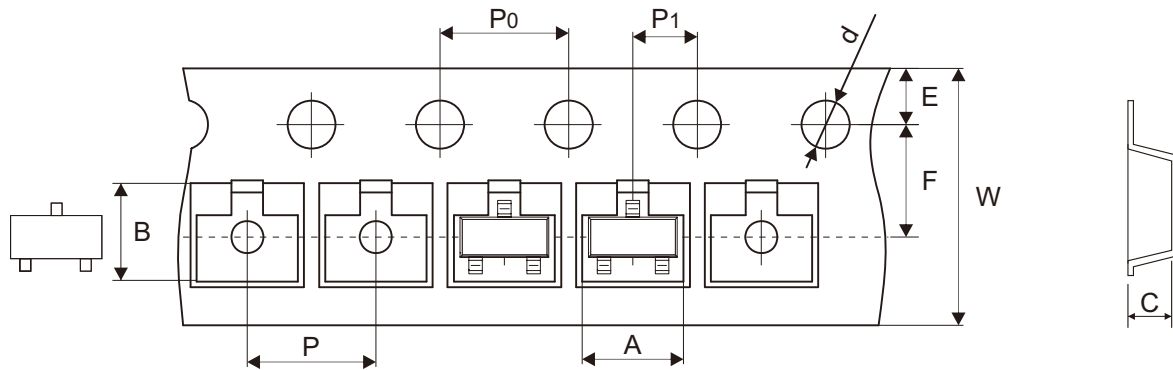

Fig.8 -  $P_C - T_a$



## Reel Taping Specification



SOT-23	SYMBOL	A	B	C	d	D	D1	D2
	(mm)	$3.15 \pm 0.10$	$2.77 \pm 0.10$	$1.22 \pm 0.10$	$1.50 \pm 0.10$	$178.00 \pm 2.00$	$54.40 \pm 1.00$	$13.00 \pm 1.00$
	(inch)	$0.124 \pm 0.004$	$0.109 \pm 0.004$	$0.048 \pm 0.004$	$0.059 \pm 0.004$	$7.008 \pm 0.079$	$2.142 \pm 0.039$	$0.512 \pm 0.039$

SOT-23	SYMBOL	E	F	P	P0	P1	W	W1
	(mm)	$1.75 \pm 0.10$	$3.50 \pm 0.10$	$4.00 \pm 0.10$	$4.00 \pm 0.10$	$2.00 \pm 0.10$	$8.00 \pm 0.10$	$12.30 \pm 1.00$
	(inch)	$0.069 \pm 0.004$	$0.138 \pm 0.004$	$0.157 \pm 0.004$	$0.157 \pm 0.004$	$0.079 \pm 0.004$	$0.315 \pm 0.004$	$0.484 \pm 0.039$

Company reserves the right to improve product design , functions and reliability without notice.

REV:A