

## MMBT5401-G (PNP)

RoHS Device

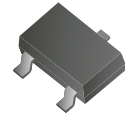

### Features

- Epitaxial planar die construction.
- Complementary NPN type available (MMBT5551-G).
- Ideal for medium power amplification and switching.

### Diagram:

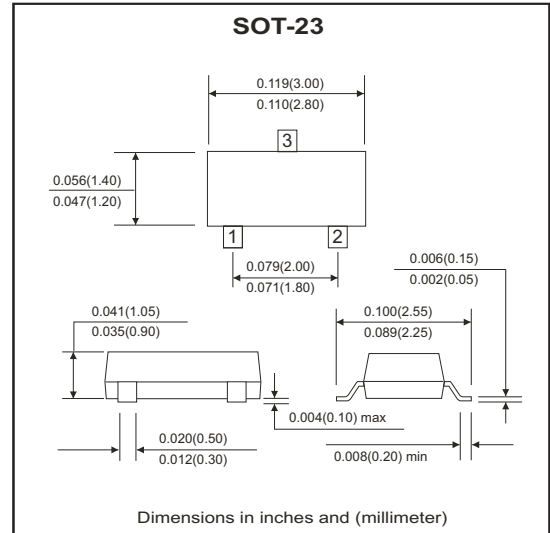
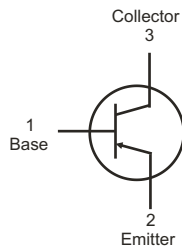

Marking: 2L

### Maximum Ratings (at TA=25°C unless otherwise noted)

Parameter	Symbol	Value	Unit
Collector-base voltage	$V_{CBO}$	-160	V
Collector-emitter voltage	$V_{CEO}$	-150	V
Emitter-base voltage	$V_{EBO}$	-5	V
Collector current - continuous	$I_C$	-0.6	A
Collector dissipation	$P_C$	0.3	W
Junction and storage temperature	$T_J, T_{STG}$	-55 ~ +150	°C

### Electrical Characteristics (at TA=25°C unless otherwise noted)

Parameter	Conditions	Symbol	Min	Max	Unit
Collector-base breakdown voltage	$I_C = -100\mu A, I_E = 0$	$V_{(BR)CBO}$	-160		V
Collector-emitter breakdown voltage	$I_C = -1mA, I_B = 0$	$V_{(BR)CEO}$	-150		V
Emitter-base breakdown voltage	$I_E = -10\mu A, I_C = 0$	$V_{(BR)EBO}$	-5		V
Collector cut-off current	$V_{CB} = -120V, I_E = 0$	$I_{CBO}$		-0.1	$\mu A$
Emitter cut-off current	$V_{EB} = -4V, I_C = 0$	$I_{EBO}$		-0.1	$\mu A$
DC current gain	$V_{CE} = -5V, I_C = -1mA$	$h_{FE(1)}$	80		
	$V_{CE} = -5V, I_C = -10mA$	$h_{FE(2)}$	100	200	
	$V_{CE} = -5V, I_C = -50mA$	$h_{FE(3)}$	50		
Collector-emitter saturation voltage	$I_C = -50mA, I_B = -5mA$	$V_{CE(sat)}$		-0.5	V
Base-emitter saturation voltage	$I_C = -50mA, I_B = -5mA$	$V_{BE(sat)}$		-1	V
Transition frequency	$V_{CE} = -5V, I_C = -10mA, f = 30MHz$	$f_T$	100		Mhz

## RATING AND CHARACTERISTIC CURVES (MMBT5401-G)

Fig.1 Max Power Dissipation vs. Ambient Temperature

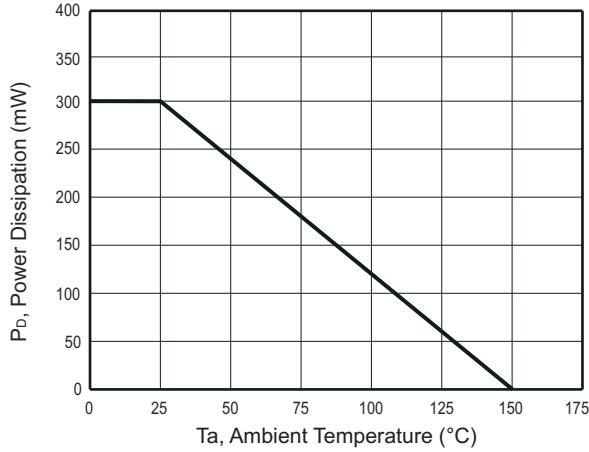

Fig.2 Collector Emitter Saturation Voltage vs. Collector Current

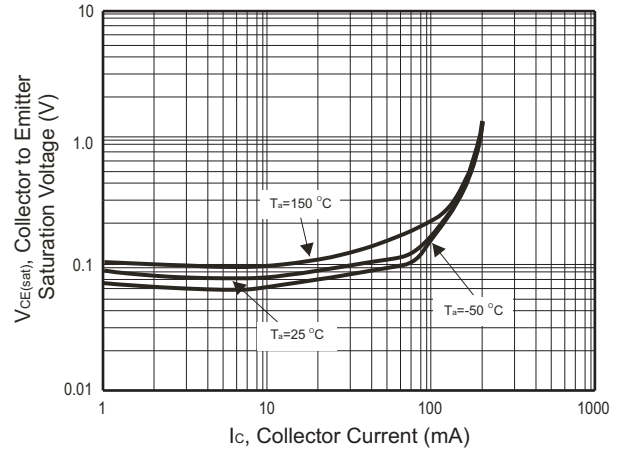

Fig.3 DC Current Gain vs. Collector Current

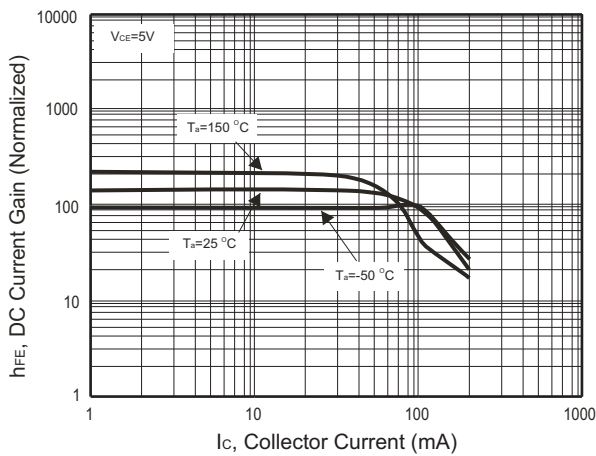

Fig.4 Base Emitter Voltage vs. Collector Current

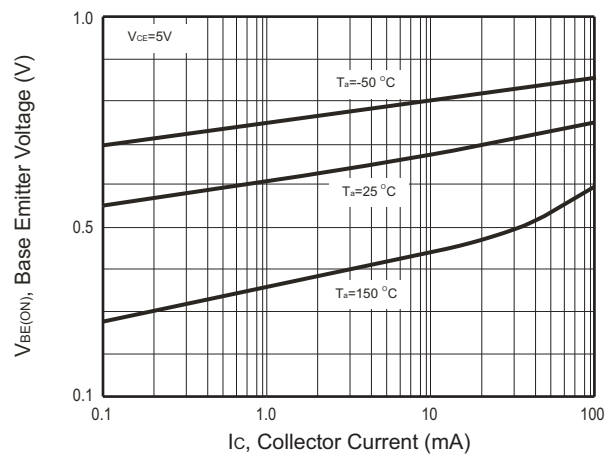
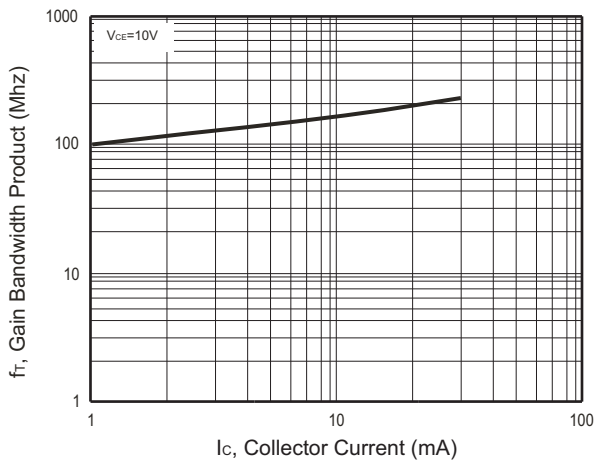
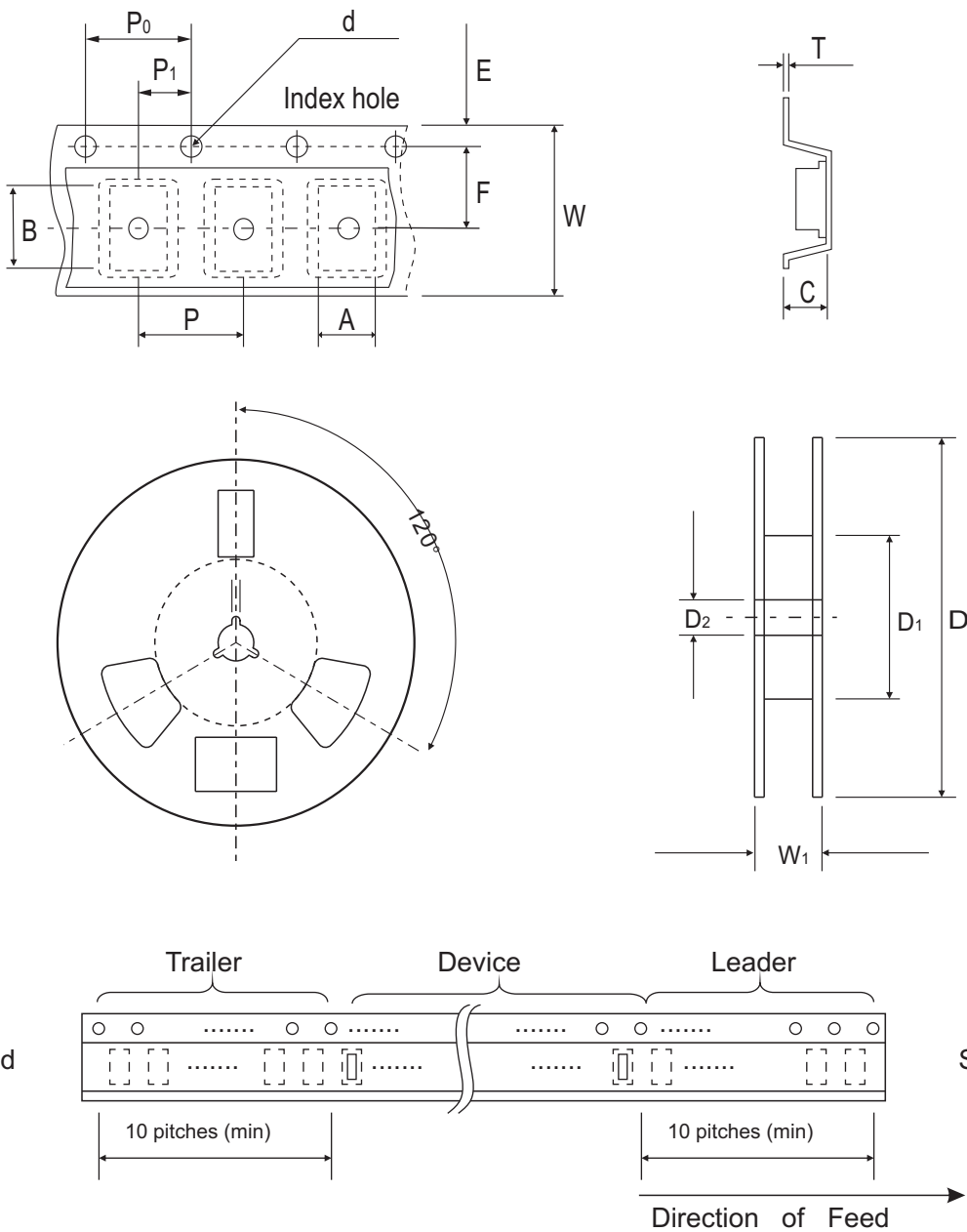

Fig.5 Gain Bandwidth Product vs. Collector Current



## Reel Taping Specification



SOT-23	SYMBOL	A	B	C	d	D	D <sub>1</sub>	D <sub>2</sub>
	(mm)	3.10 ± 0.10	2.85 ± 0.10	1.40 ± 0.10	1.55 ± 0.10	178 ± 1	50.0 MIN.	13.0 ± 0.20
	(inch)	0.122 ± 0.004	0.112 ± 0.004	0.055 ± 0.004	0.061 ± 0.004	7.008 ± 0.04	1.969 MIN.	0.512 ± 0.008

SOT-23	SYMBOL	E	F	P	P <sub>0</sub>	P <sub>1</sub>	W	W <sub>1</sub>
	(mm)	1.75 ± 0.10	3.50 ± 0.05	4.00 ± 0.10	4.00 ± 0.10	2.00 ± 0.05	8.00 ± 0.30	14.4 MAX.
	(inch)	0.069 ± 0.004	0.138 ± 0.002	0.157 ± 0.004	0.157 ± 0.004	0.079 ± 0.002	0.315 ± 0.012	0.567 MAX.