



# MMBT5401

## HIGH VOLTAGE TRANSISTOR PNP Silicon

### FEATURES

- Lead free in compliance with EU RoHS 2.0
- Green molding compound as per IEC 61249 standard

### MECHANICAL DATA

- Case : SOT-23 plastic case.
- Terminals : Solderable per MIL-STD-750, Method 2026
- Standard packaging : 8mm tape
- Approx. Weight : 0.0003 ounces, 0.008 grams
- Marking : M5A

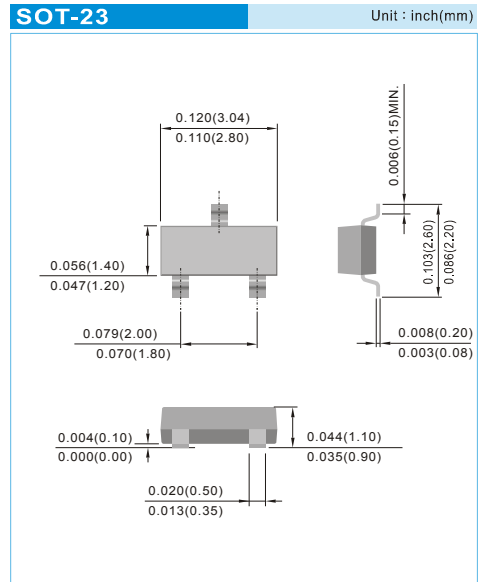

### MAXIMUM RATINGS

RATING	SYMBOL	VALUE	UNITS
Collector-Emitter Voltage	$V_{CE0}$	-150	Vdc
Collector-Base Voltage	$V_{CB0}$	-160	Vdc
Emitter-Base Voltage	$V_{EB0}$	-5.0	Vdc
Collector Current-Continuous	$I_C$	-600	mAdc

Maximum ratings are those values beyond which device damage can occur. Maximum ratings applied to the device are individual stress limit values (not normal operating conditions) and are not valid simultaneously. If these limits are exceeded, device functional operational is not implied, damage may occur and reliability may be affected.

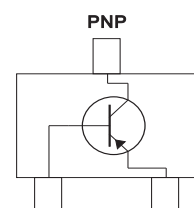

**Fig.35**



# MMBT5401

## THERMAL CHARACTERISTICS

CHARACTERISTIC	SYMBOL	MAX	UNITS
Total Device Dissipation FR-4 Board (Note 1) T <sub>A</sub> =25°C Derate Above 25°C	P <sub>D</sub>	225	mW
		1.8	mW/°C
Thermal Resistance, Junction-to-Ambient	R <sub>θJA</sub>	556	°C/W
Total Device Dissipation Alumina Substrate (Note 2) T <sub>A</sub> =25°C Derate Above 25°C	P <sub>D</sub>	300	mW
		2.4	mW/°C
Thermal Resistance Junction-to-Ambient	R <sub>θJA</sub>	417	°C/W
Junction and Storage Temperature	T <sub>J</sub> , T <sub>STG</sub>	-55 to +150	°C

1.FR-4 = 70 X 60 X 1mm

2.Alumina = 0.4 X 0.3 X 0.024 in 99.5% alumina

## ELECTRICAL CHARACTERISTICS (T<sub>A</sub>=25°C unless otherwise noted)

CHARACTERISTIC	SYMBOL	MIN	MAX	UNITS
<b>OFF CHARACTERISTICS</b>				
Collector-Emitter Breakdown Voltage (I <sub>C</sub> =-1.0mA <sub>dc</sub> , I <sub>B</sub> =0)	V <sub>(BR)CEO</sub>	-150	-	V <sub>dc</sub>
Collector-Base Breakdown Voltage (I <sub>C</sub> =-100μA <sub>dc</sub> , I <sub>E</sub> =0)	V <sub>(BR)CBO</sub>	-160	-	V <sub>dc</sub>
Emitter-Base Breakdown Voltage (I <sub>E</sub> =-10μA <sub>dc</sub> , I <sub>C</sub> =0)	V <sub>(BR)EBO</sub>	-5.0	-	V <sub>dc</sub>
Collector Cutoff Current (V <sub>CB</sub> =-120V <sub>dc</sub> , I <sub>E</sub> =0) (V <sub>CB</sub> =-120V <sub>dc</sub> , I <sub>E</sub> =0, T <sub>A</sub> =100°C)	I <sub>CBO</sub>	-	-50 -50	nA <sub>dc</sub> μA <sub>dc</sub>
<b>ON CHARACTERISTICS</b>				
DC Current Gain (I <sub>C</sub> =-1.0mA <sub>dc</sub> , V <sub>CE</sub> =-5.0V <sub>dc</sub> ) (I <sub>C</sub> =-10mA <sub>dc</sub> , V <sub>CE</sub> =-5.0V <sub>dc</sub> ) (I <sub>C</sub> =-50mA <sub>dc</sub> , V <sub>CE</sub> =-5.0V <sub>dc</sub> )	h <sub>FE</sub>	50 60 50	- 240 -	-
Collector-Emitter Saturation Voltage (I <sub>C</sub> =-10mA <sub>dc</sub> , I <sub>B</sub> =-1.0mA <sub>dc</sub> ) (I <sub>C</sub> =-50mA <sub>dc</sub> , I <sub>B</sub> =-5.0mA <sub>dc</sub> )	V <sub>CE(SAT)</sub>	- -	-0.2 -0.5	V <sub>dc</sub>
Base-Emitter Saturation Voltage (I <sub>C</sub> =-10mA <sub>dc</sub> , I <sub>B</sub> =-1.0mA <sub>dc</sub> ) (I <sub>C</sub> =-50mA <sub>dc</sub> , I <sub>B</sub> =-5.0mA <sub>dc</sub> )	V <sub>BE(SAT)</sub>	- -	-1.0 -1.0	V <sub>dc</sub>
<b>SMALL-SIGNAL CHARACTERISTICS</b>				
Current-Gain-Bandwidth Product (I <sub>C</sub> =-10mA <sub>dc</sub> , V <sub>CE</sub> =-10V <sub>dc</sub> , f=100MHz)	f <sub>r</sub>	100	300	MHz
Output Capacitance (V <sub>CB</sub> =-10V <sub>dc</sub> , I <sub>E</sub> =0, f=1.0MHz)	C <sub>OB0</sub>	-	6.0	pF
Small Signal Current Gain (I <sub>C</sub> =-1.0mA <sub>dc</sub> , V <sub>CE</sub> =-10V <sub>dc</sub> , f=1.0kHz)	h <sub>FE</sub>	40	200	-
Noise Figure (I <sub>C</sub> =-200μA <sub>dc</sub> , V <sub>CE</sub> =-5.0V <sub>dc</sub> , R <sub>s</sub> =10Ω, f=1.0kHz)	NF	-	8.0	dB



# MMBT5401

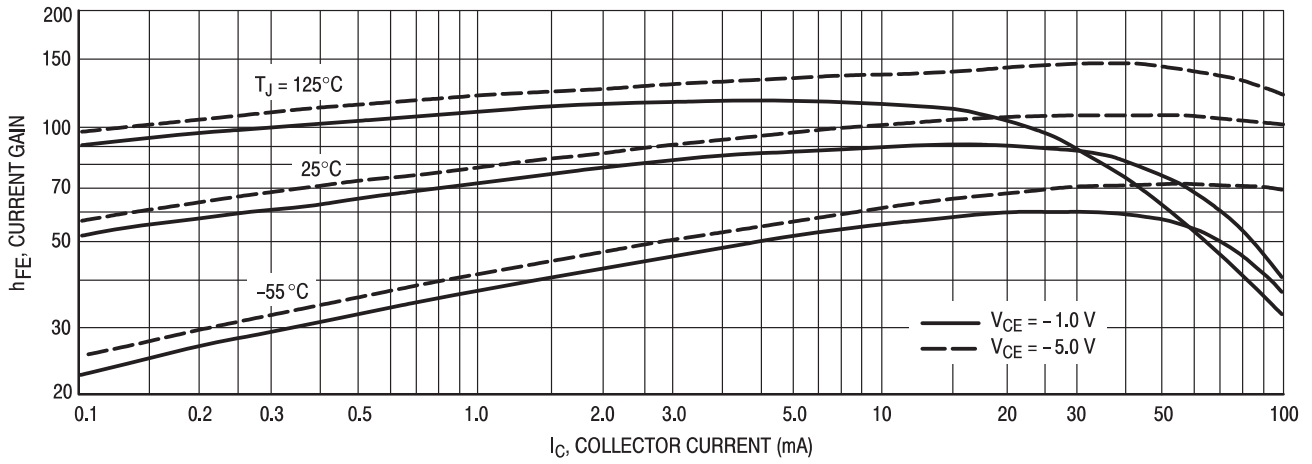

**Figure 1. DC Current Gain**

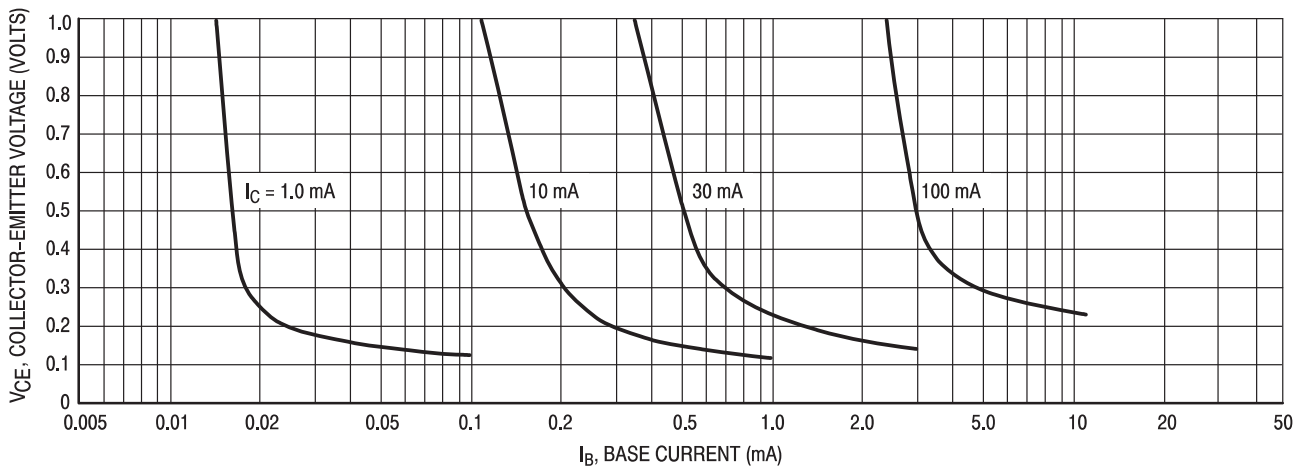

**Figure 2. Collector Saturation Region**

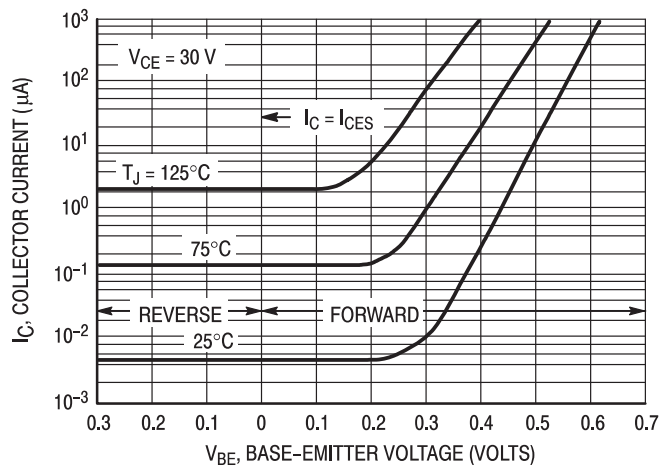

**Figure 3. Collector Cut-Off Region**



# MMBT5401

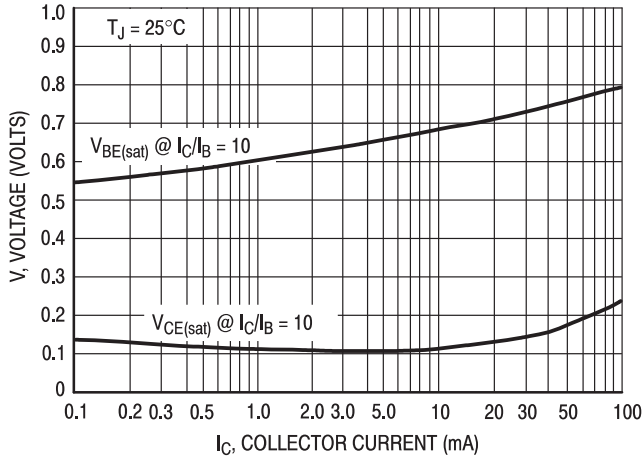

Figure 4. "On" Voltages

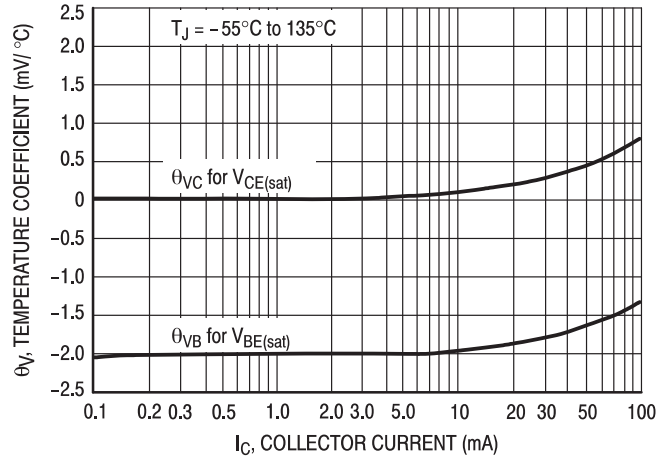
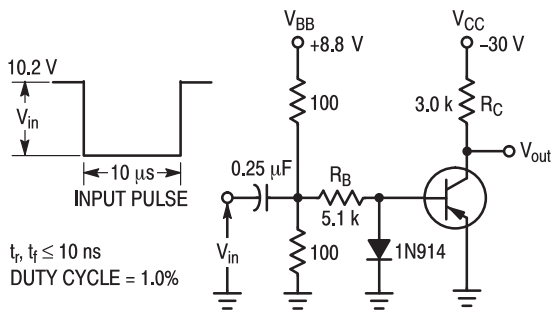

Figure 5. Temperature Coefficients



Values Shown are for  $I_C @ 10 \text{ mA}$

Figure 6. Switching Time Test Circuit

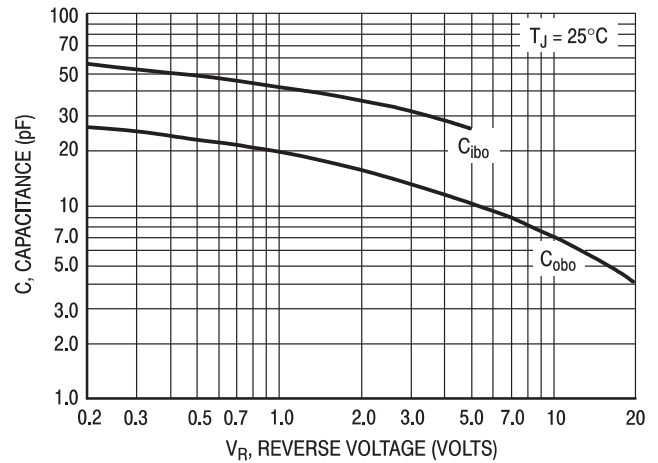

Figure 7. Capacitances

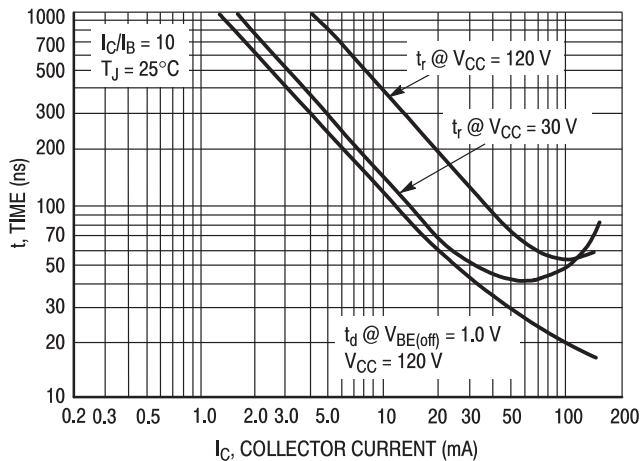

Figure 8. Turn-On Time

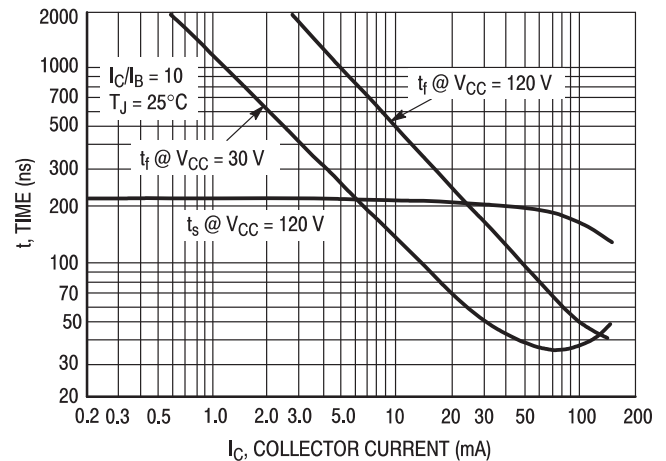
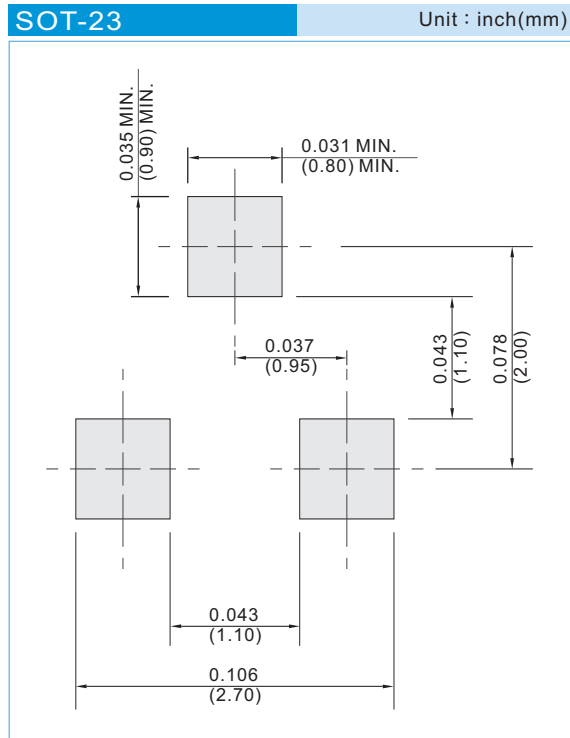

Figure 9. Turn-Off Time



# MMBT5401

## MOUNTING PAD LAYOUT



## ORDER INFORMATION

- Packing information  
T/R - 12K per 13" plastic Reel  
T/R - 3K per 7" plastic Reel



# MMBT5401

## Part No\_packing code\_Version

MMBT5401\_R1\_00001

MMBT5401\_R2\_00001

For example :

**RB500V-40\_R2\_00001**



Packing Code <b>XX</b>				Version Code <b>XXXXX</b>		
Packing type	1 <sup>st</sup> Code	Packing size code	2 <sup>nd</sup> Code	HF or RoHS	1 <sup>st</sup> Code	2 <sup>nd</sup> ~5 <sup>th</sup> Code
Tape and Ammunition Box (T/B)	<b>A</b>	N/A	<b>0</b>	<b>HF</b>	<b>0</b>	serial number
Tape and Reel (T/R)	<b>R</b>	7"	<b>1</b>	<b>RoHS</b>	<b>1</b>	serial number
Bulk Packing (B/P)	<b>B</b>	13"	<b>2</b>			
Tube Packing (T/P)	<b>T</b>	26mm	<b>X</b>			
Tape and Reel (Right Oriented) (TRR)	<b>S</b>	52mm	<b>Y</b>			
Tape and Reel (Left Oriented) (TRL)	<b>L</b>	PANASERT T/B CATHODE UP (PBCU)	<b>U</b>			
FORMING	<b>F</b>	PANASERT T/B CATHODE DOWN (PBCD)	<b>D</b>			