

MMBTA56-HF (PNP)

RoHS Device

Halogen Free

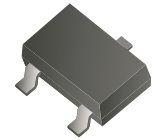

Features

- Power dissipation of 225mW.
- High stability and high reliability.

Mechanical data

- Case: SOT-23, molded plastic.
- Epoxy : UL 94V-0.
- Mounting position: Any.

Circuit Diagram

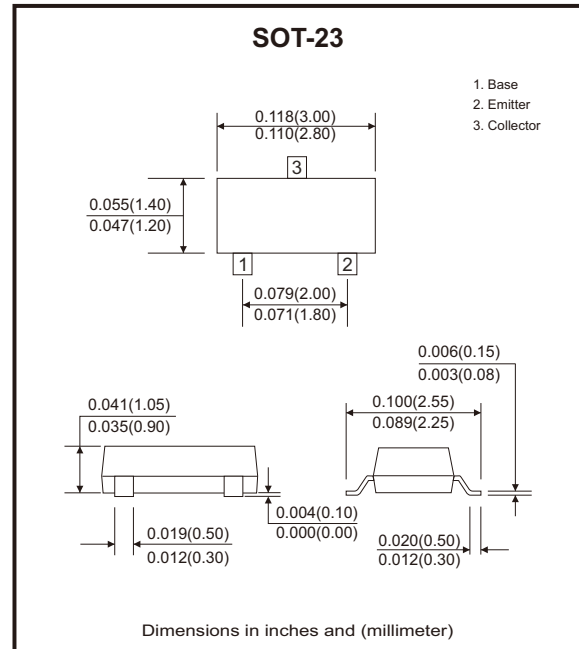
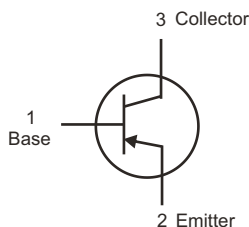

Maximum Ratings (at TA=25°C unless otherwise noted)

Parameter	Symbol	Value	Unit
Collector-base voltage	V _{CB0}	-80	V
Collector-emitter voltage	V _{CEO}	-80	V
Emitter-base voltage	V _{EB0}	-4	V
Collector current-continuous	I _c	-500	mA
Collector power dissipation	P _c	225	mW
Junction temperature	T _J	150	°C
Storage temperature range	T _{STG}	-55 to +150	°C
Thermal resistance, junction to ambient	R _{θJA}	555	°C/W

Electrical Characteristics (at $T_A=25^\circ\text{C}$ unless otherwise noted)

Parameter	Conditions	Symbol	Min	Max	Unit
Collector-base breakdown voltage	$I_C = -100\mu\text{A}, I_E = 0$	$V_{(BR)CBO}$	-80		V
Collector-emitter breakdown voltage (Note 1)	$I_C = -1\text{mA}, I_B = 0$	$V_{(BR)CEO}$	-80		V
Emitter-base breakdown voltage	$I_E = -100\mu\text{A}, I_C = 0$	$V_{(BR)EBO}$	-4		V
Collector cut-off current	$V_{CB} = -80\text{V}, I_E = 0$	I_{CBO}		-100	nA
Emitter cut-off current	$V_{EB} = -4\text{V}, I_C = 0$	I_{EBO}		-100	nA
Collector cut-off current	$V_{CE} = -60\text{V}, I_B = 0$	I_{CEO}		-1.0	μA
DC current gain (Note 1)	$V_{CE} = -1\text{V}, I_C = -10\text{mA}$	$h_{FE(1)}$	100	400	
	$V_{CE} = -1\text{V}, I_C = -100\text{mA}$	$h_{FE(2)}$	100		
Collector-emitter saturation voltage (Note 1)	$I_C = -100\text{mA}, I_B = -10\text{mA}$	$V_{CE(sat)}$		-0.25	V
Base-emitter voltage	$V_{CE} = -1\text{V}, I_C = -100\text{mA}$	V_{BE}		-1.20	V
Transition frequency	$V_{CE} = -1\text{V}, I_C = -100\text{mA}, f = 100\text{MHz}$	f_T	50		MHz

Note: 1. Pulse width $\leq 300\mu\text{s}$, duty cycle $\leq 2.0\%$.

Rating and Characteristic Curves (MMBTA56-HF)

Fig.1 - Static Characteristic

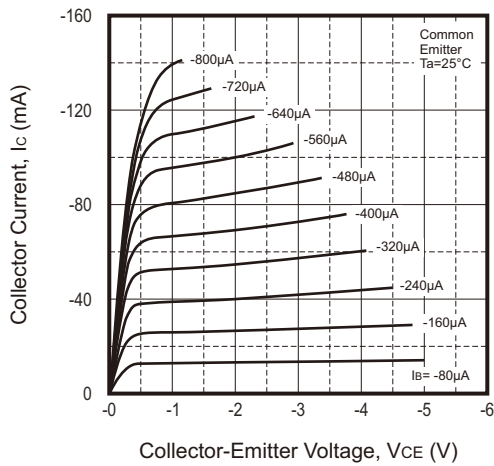

Fig.2 - $h_{FE} - I_C$

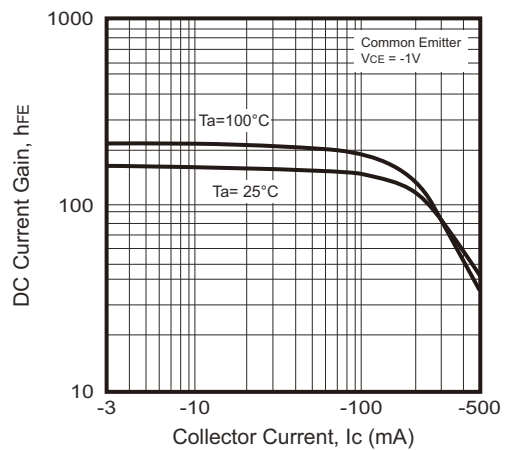

Fig.3 - $V_{CEsat} - I_C$

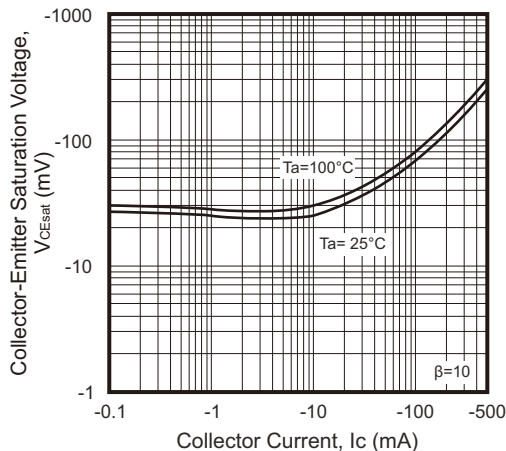
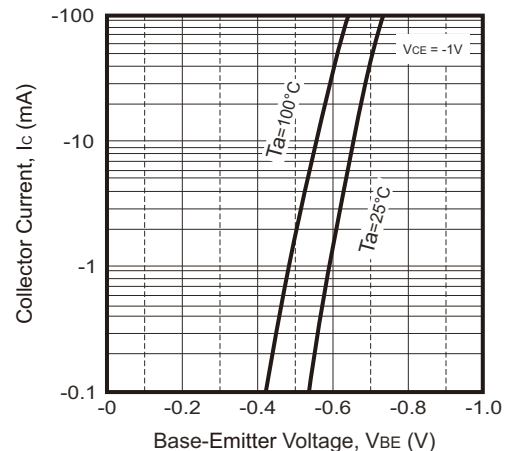

Fig.4 - $V_{BE} - I_C$



Company reserves the right to improve product design, functions and reliability without notice.

REV:A

Rating and Characteristic Curves (MMBTA56-HF)

Fig.5 - C_{ob}/C_{ib} — V_{CB}/V_{EB}

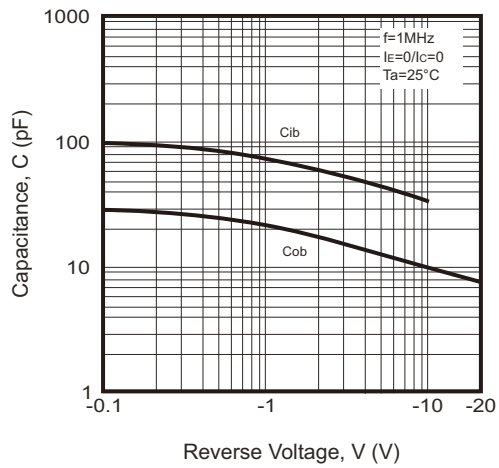

Fig.6 - f_T — I_C

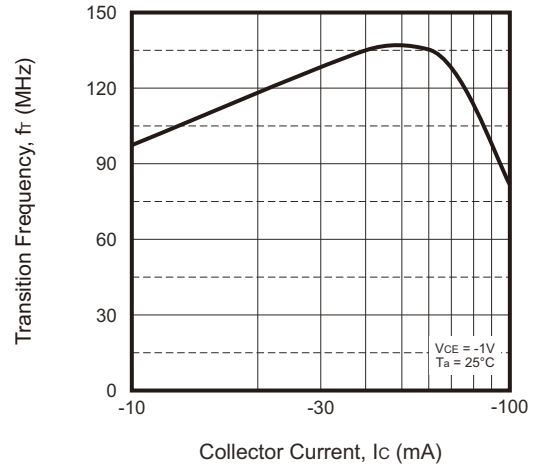
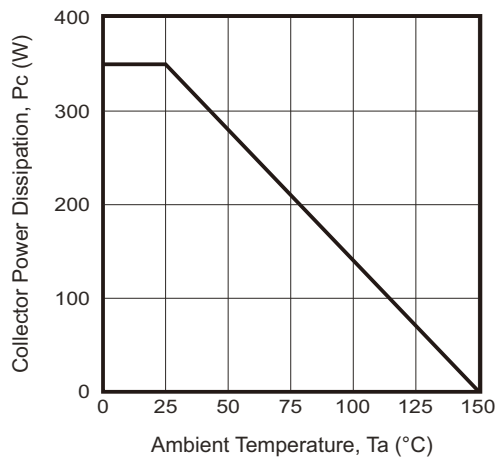
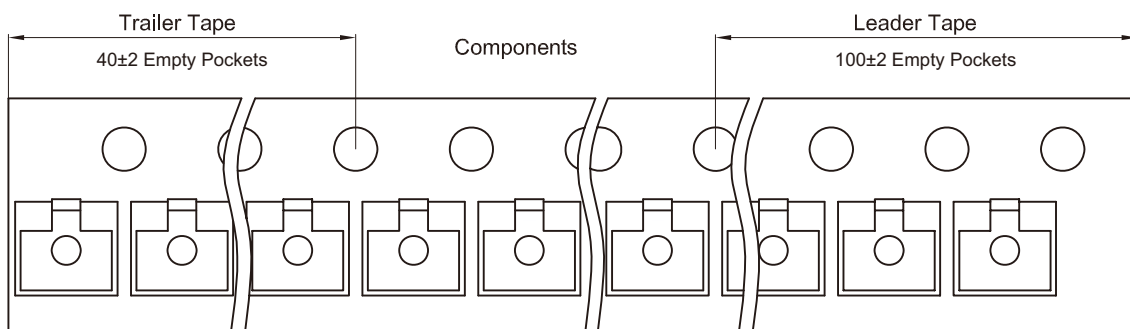
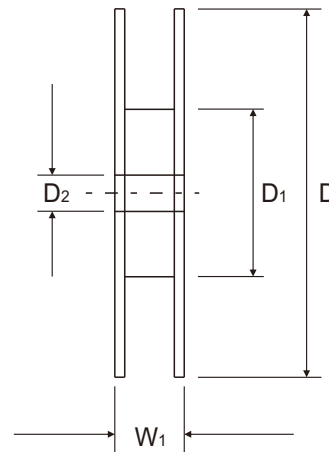
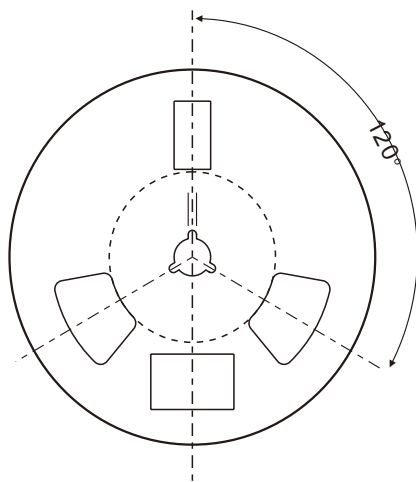
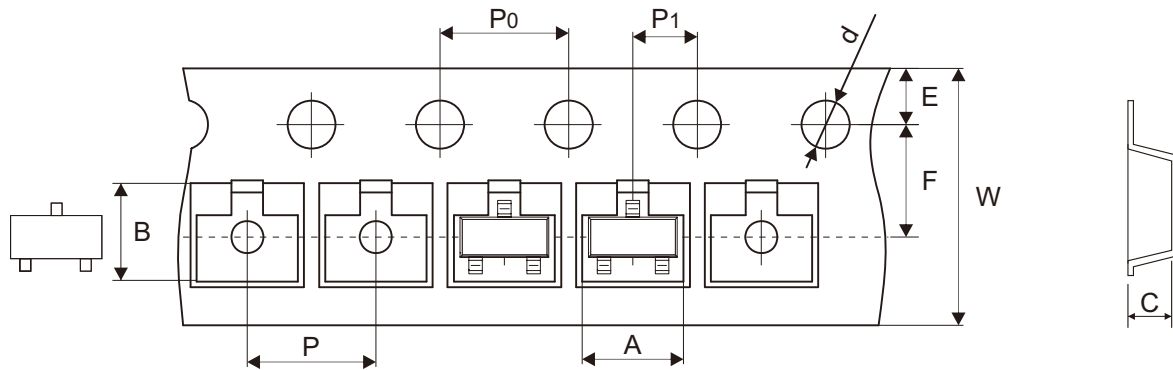

Fig.7 - P_C — T_a



Reel Taping Specification



SOT-23	SYMBOL	A	B	C	d	D	D1	D2
	(mm)	3.15 ± 0.10	2.77 ± 0.10	1.22 ± 0.10	1.50 ± 0.10	178.00 ± 2.00	54.40 ± 1.00	13.00 ± 1.00
	(inch)	0.124 ± 0.004	0.109 ± 0.004	0.048 ± 0.004	0.059 ± 0.004	7.008 ± 0.079	2.142 ± 0.039	0.512 ± 0.039

SOT-23	SYMBOL	E	F	P	P0	P1	W	W1
	(mm)	1.75 ± 0.10	3.50 ± 0.10	4.00 ± 0.10	4.00 ± 0.10	2.00 ± 0.10	8.00 ± 0.10	12.30 ± 1.00
	(inch)	0.069 ± 0.004	0.138 ± 0.004	0.157 ± 0.004	0.157 ± 0.004	0.079 ± 0.004	0.315 ± 0.004	0.472 ± 0.039