

## MMBTA92-HF (PNP)

RoHS Device  
Halogen Free

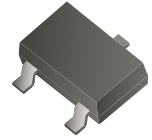

### Features

- Power dissipation of 300mW.
- High stability and high reliability.

### Mechanical data

- Case: SOT-23, molded plastic.
- Epoxy : UL 94V-0.
- Mounting position: Any.

### Circuit Diagram

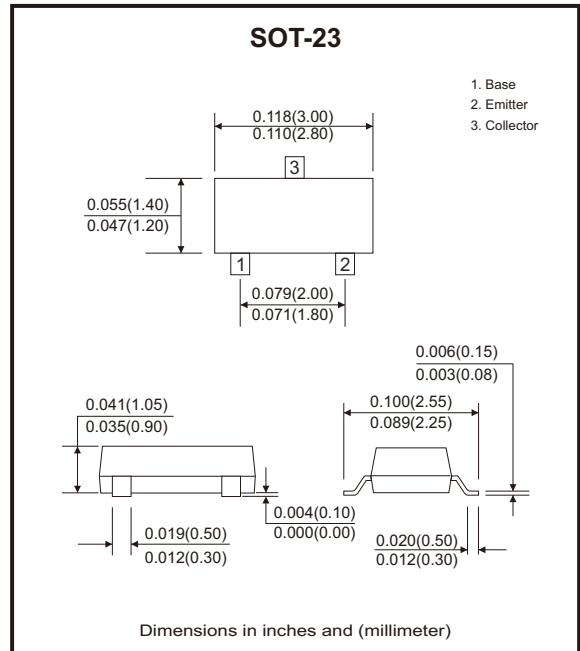
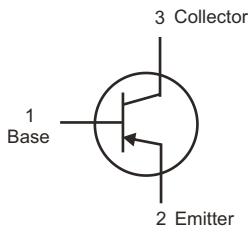

### Maximum Ratings (at TA=25°C unless otherwise noted)

Parameter	Symbol	Value	Unit
Collector-base voltage	V <sub>CBO</sub>	-300	V
Collector-emitter voltage	V <sub>CEO</sub>	-300	V
Emitter-base voltage	V <sub>EBO</sub>	-5	V
Collector current-continuous	I <sub>C</sub>	-200	mA
Collector power dissipation	P <sub>C</sub>	300	mW
Junction temperature	T <sub>J</sub>	150	°C
Storage temperature range	T <sub>STG</sub>	-55 to +150	°C
Thermal resistance, junction to ambient	R <sub>θJA</sub>	417	°C/W

## Electrical Characteristics (at $T_A=25^\circ\text{C}$ unless otherwise noted)

Parameter	Conditions	Symbol	Min	Max	Unit
Collector-base breakdown voltage	$I_C = -100\mu\text{A}, I_E = 0$	$V_{(BR)CBO}$	-300		V
Collector-emitter breakdown voltage (Note 1)	$I_C = -1\text{mA}, I_B = 0$	$V_{(BR)CEO}$	-300		V
Emitter-base breakdown voltage	$I_E = -100\mu\text{A}, I_C = 0$	$V_{(BR)EBO}$	-5		V
Collector cut-off current	$V_{CB} = -200\text{V}, I_E = 0$	$I_{CBO}$		-250	nA
Emitter cut-off current	$V_{EB} = -5\text{V}, I_C = 0$	$I_{EBO}$		-100	nA
DC current gain (Note 1)	$V_{CE} = -10\text{V}, I_C = -1\text{mA}$	$h_{FE(1)}$	60		
	$V_{CE} = -10\text{V}, I_C = -10\text{mA}$	$h_{FE(2)}$	100	200	
	$V_{CE} = -10\text{V}, I_C = -30\text{mA}$	$h_{FE(3)}$	60		
Collector-emitter saturation voltage (Note 1)	$I_C = -20\text{mA}, I_B = -2\text{mA}$	$V_{CE(sat)}$		-0.2	V
Base-emitter saturation voltage (Note 1)	$I_C = -20\text{mA}, I_B = -2\text{mA}$	$V_{BE(sat)}$		-0.9	V
Transition frequency	$V_{CE} = -20\text{V}, I_C = 10\text{mA}, f = 30\text{MHz}$	$f_T$	50		MHz

Note: 1. Pulse width  $\leq 300\mu\text{s}$ , duty cycle  $\leq 2.0\%$ .

## Rating and Characteristic Curves (MMBTA92-HF)

Fig.1 -  $I_C - V_{CE}$

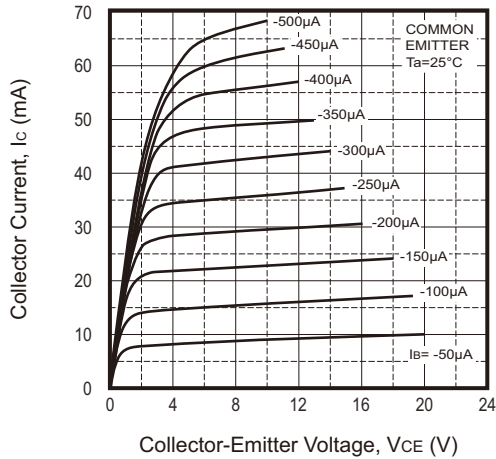

Fig.2 -  $h_{FE} - I_C$

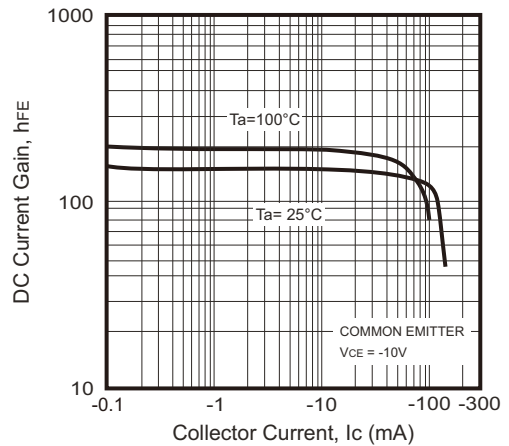

Fig.3 -  $V_{CEsat} - I_C$

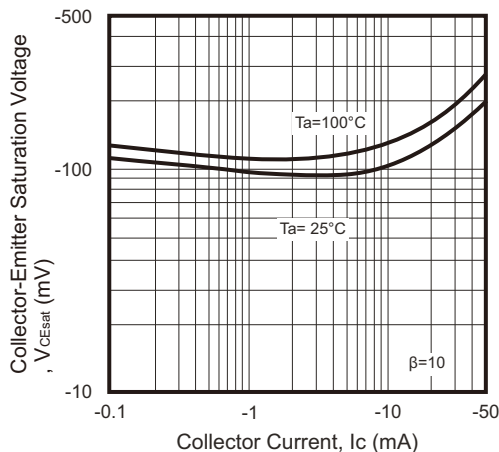
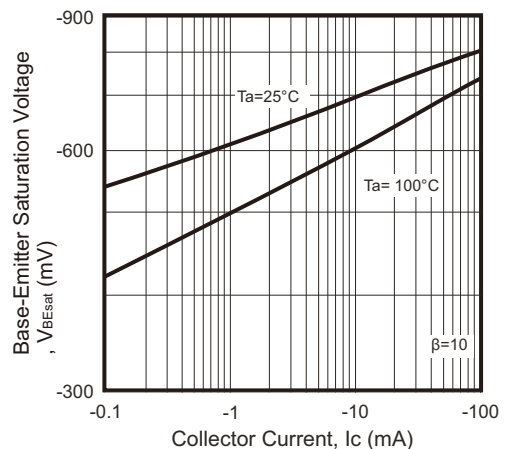

Fig.4 -  $V_{BEsat} - I_C$



Company reserves the right to improve product design, functions and reliability without notice.

## Rating and Characteristic Curves (MMBTA92-HF)

Fig.5 -  $I_c - V_{BE}$

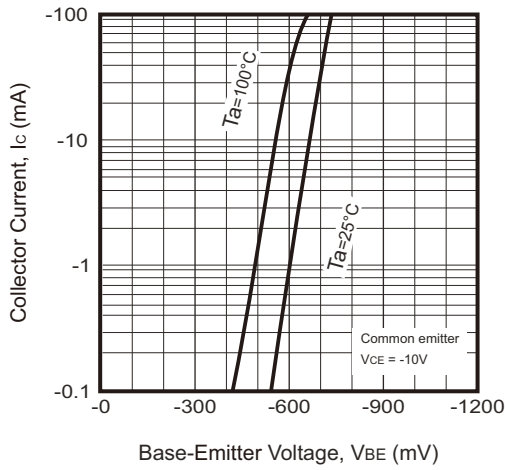

Fig.6 -  $f_r - I_c$

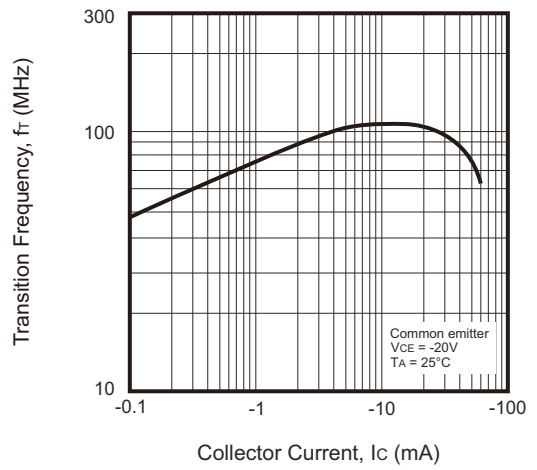

Fig.7 -  $C_{ob}/C_{ib} - V_{CB}/V_{EB}$

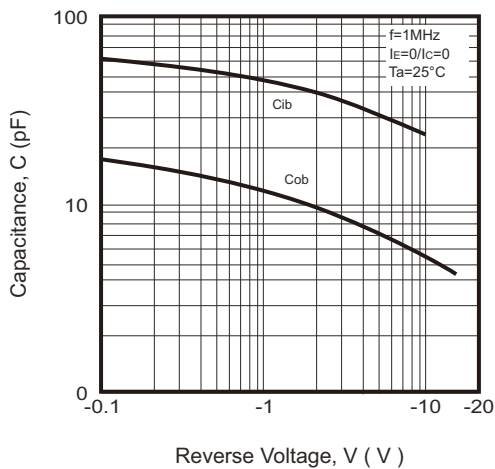
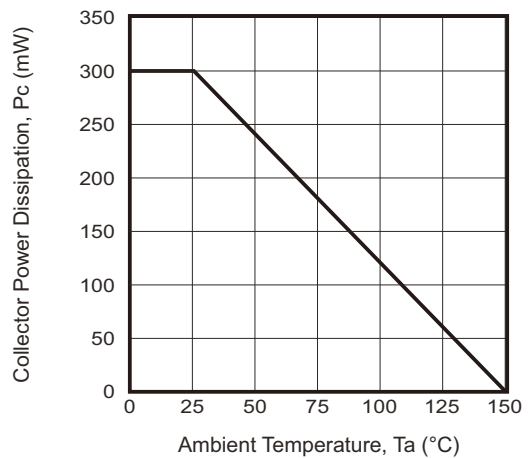
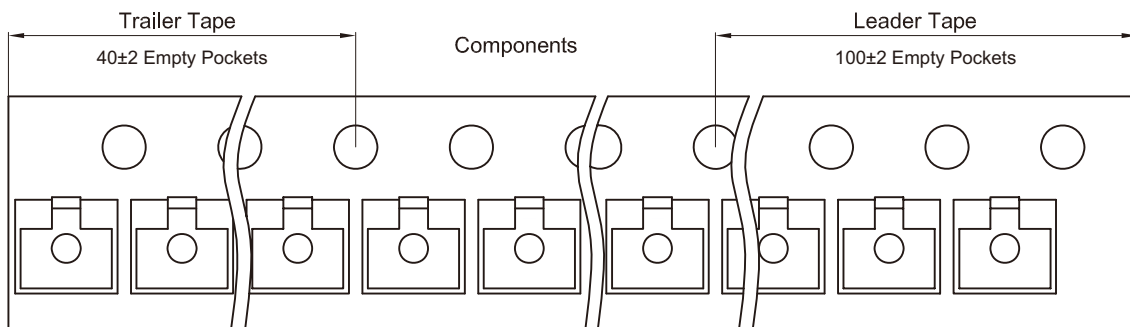
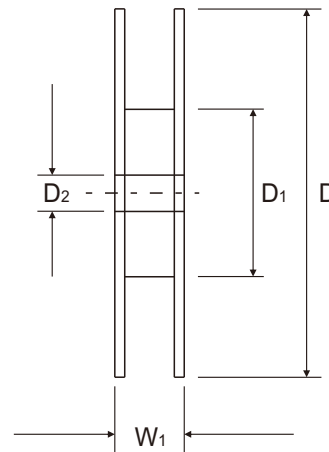
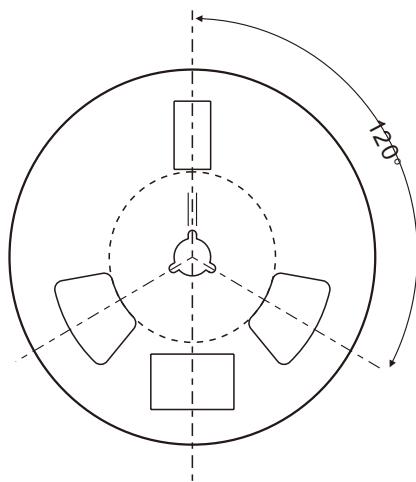
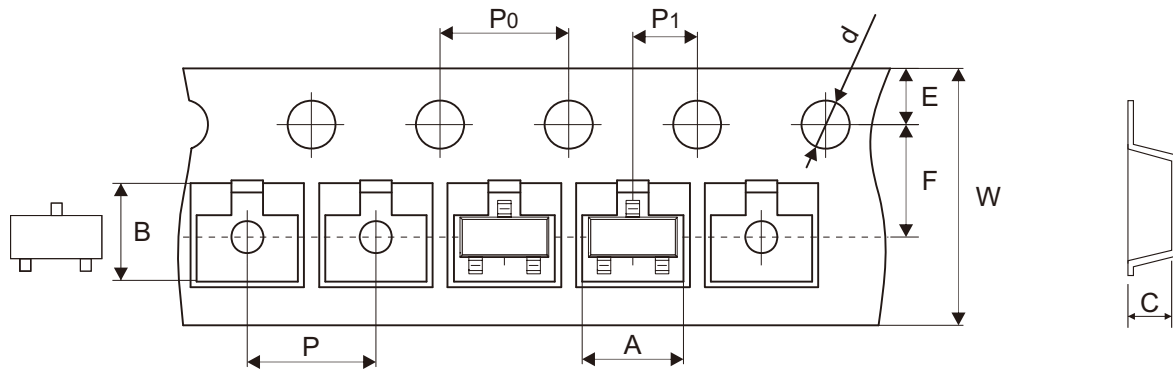

Fig.8 -  $P_c - T_a$



## Reel Taping Specification



SOT-23	SYMBOL	A	B	C	d	D	D1	D2
	(mm)	$3.15 \pm 0.10$	$2.77 \pm 0.10$	$1.22 \pm 0.10$	$1.50 \pm 0.10$	$178.00 \pm 2.00$	$54.40 \pm 1.00$	$13.00 \pm 1.00$
	(inch)	$0.124 \pm 0.004$	$0.109 \pm 0.004$	$0.048 \pm 0.004$	$0.059 \pm 0.004$	$7.008 \pm 0.079$	$2.142 \pm 0.039$	$0.512 \pm 0.039$

SOT-23	SYMBOL	E	F	P	P0	P1	W	W1
	(mm)	$1.75 \pm 0.10$	$3.50 \pm 0.10$	$4.00 \pm 0.10$	$4.00 \pm 0.10$	$2.00 \pm 0.10$	$8.00 \pm 0.10$	$12.30 \pm 1.00$
	(inch)	$0.069 \pm 0.004$	$0.138 \pm 0.004$	$0.157 \pm 0.004$	$0.157 \pm 0.004$	$0.079 \pm 0.004$	$0.315 \pm 0.004$	$0.472 \pm 0.039$