



# Heterojunction Bipolar Transistor Technology (InGaP HBT)

## Broadband High Linearity Amplifier

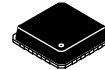
The MMG3006NT1 is a general purpose amplifier that is internally input prematched and designed for a broad range of Class A, small-signal, high linearity, general purpose applications. It is suitable for applications with frequencies from 400 to 2400 MHz such as cellular, PCS, WLL, PHS, VHF, UHF, UMTS and general small-signal RF.

### Features

- Frequency: 400–2400 MHz
- P1dB: 33 dBm @ 900 MHz
- Small-signal gain: 17.5 dB @ 900 MHz
- Third order output intercept point: 49 dBm @ 900 MHz
- Single 5 V supply
- Internally input prematched to 50 ohms

**MMG3006NT1**

**400–2400 MHz, 17.5 dB  
33 dBm  
InGaP HBT GPA**



**QFN 4 × 4–16L**

**Table 1. Typical Performance (1)**

| Characteristic                     | Symbol | 900 MHz | 1960 MHz | 2140 MHz | Unit |
|------------------------------------|--------|---------|----------|----------|------|
| Small-Signal Gain (S21)            | $G_p$  | 17.5    | 14       | 14       | dB   |
| Input Return Loss (S11)            | IRL    | -8      | -9       | -12      | dB   |
| Output Return Loss (S22)           | ORL    | -13     | -14      | -18      | dB   |
| Power Output @1dB Compression      | P1db   | 33      | 33       | 33       | dBm  |
| Third Order Output Intercept Point | OIP3   | 49      | 49       | 49       | dBm  |

1.  $V_{DC} = 5$  Vdc,  $T_A = 25^\circ\text{C}$ , 50 ohm system, application circuit tuned for specified frequency.

**Table 2. Maximum Ratings**

| Rating                    | Symbol    | Value       | Unit             |
|---------------------------|-----------|-------------|------------------|
| Supply Voltage            | $V_{DC}$  | 6           | V                |
| Supply Current            | $I_{DC}$  | 1400        | mA               |
| RF Input Power            | $P_{in}$  | 28          | dBm              |
| Storage Temperature Range | $T_{stg}$ | -65 to +150 | $^\circ\text{C}$ |
| Junction Temperature      | $T_J$     | 175         | $^\circ\text{C}$ |

**Table 3. Thermal Characteristics**

| Characteristic  | Symbol          | Value (2) | Unit               |
|---|-----------------|-----------|--------------------|
| Thermal Resistance, Junction to Case<br>Case Temperature 89 $^\circ\text{C}$ , 5 Vdc, 850 mA, no RF applied | $R_{\theta JC}$ | 7.8       | $^\circ\text{C/W}$ |

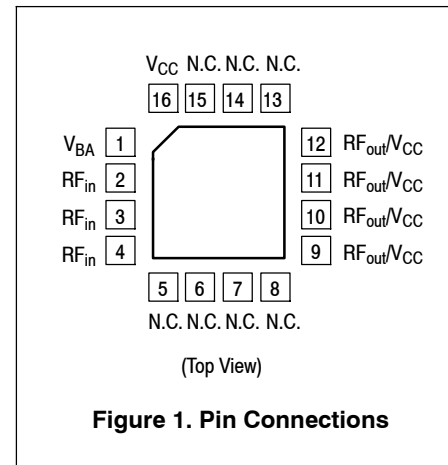
2. Refer to AN1955, *Thermal Measurement Methodology of RF Power Amplifiers*. Go to <http://www.nxp.com/RF> and search for AN1955.

**Table 4. Electrical Characteristics** ( $V_{DC} = 5$  Vdc, 900 MHz,  $T_A = 25^\circ\text{C}$ , 50 ohm system, in NXP Application Circuit)

| Characteristic                     | Symbol   | Min  | Typ  | Max | Unit |
|------------------------------------|----------|------|------|-----|------|
| Small-Signal Gain (S21)            | $G_p$    | 16.5 | 17.5 | —   | dB   |
| Input Return Loss (S11)            | IRL      | —    | -8   | —   | dB   |
| Output Return Loss (S22)           | ORL      | —    | -13  | —   | dB   |
| Power Output @ 1dB Compression     | P1dB     | —    | 33   | —   | dBm  |
| Third Order Output Intercept Point | OIP3     | —    | 49   | —   | dBm  |
| Noise Figure                       | NF       | —    | 6.6  | —   | dB   |
| Supply Current                     | $I_{DC}$ | 760  | 850  | 960 | mA   |
| Supply Voltage                     | $V_{DC}$ | —    | 5    | —   | V    |

**Table 5. Functional Pin Description**

| Name              | Pin Number            | Description   |
|-------------------|-----------------------|---|
| $V_{BA}$          | 1                     | Bias voltage supply.  |
| $RF_{in}$         | 2, 3, 4               | RF input for the power amplifier. This pin is DC-coupled and requires a DC-blocking series capacitor.                         |
| $RF_{out}/V_{CC}$ | 9, 10, 11, 12         | RF output for the power amplifier. This pin is DC-coupled and requires a DC-blocking series capacitor.                        |
| $V_{CC}$          | 16                    | Collector voltage supply.   |
| GND               | Backside Center Metal | The center metal base of the QFN package provides both DC and RF ground as well as heat sink contact for the power amplifier. |

**Table 6. ESD Protection Characteristics**

| Test Conditions/Test Methodology       | Class |
|--|-------|
| Human Body Model (per JESD 22-A114)    | 1C    |
| Machine Model (per EIA/JESD 22-A115)   | A     |
| Charge Device Model (per JESD 22-C101) | IV    |

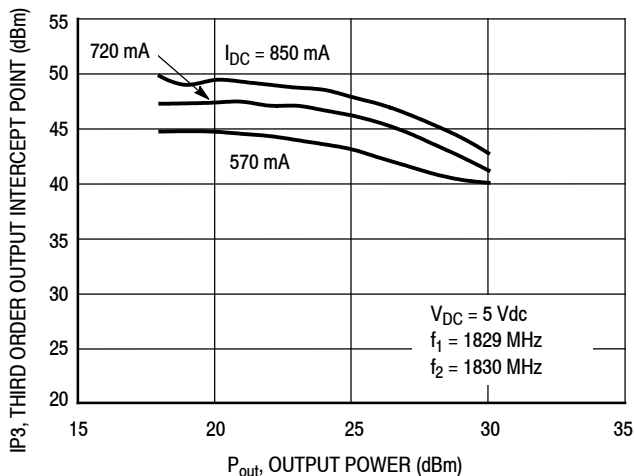
**Table 7. Moisture Sensitivity Level**

| Test Methodology                      | Rating | Package Peak Temperature | Unit             |
|---------------------------------------|--------|--------------------------|------------------|
| Per JESD 22-A113, IPC/JEDEC J-STD-020 | 1      | 260                      | $^\circ\text{C}$ |

**Table 8. Ordering Information**

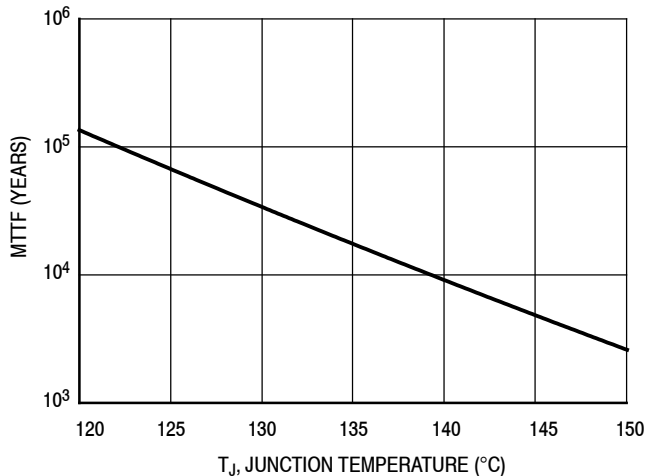
| Device     | Tape and Reel Information                               | Package       |
|------------|---|---------------|
| MMG3006NT1 | T1 Suffix = 1,000 Units, 12 mm Tape Width, 13-inch Reel | QFN 4 x 4-16L |

### 50 OHM TYPICAL CHARACTERISTICS



NOTE: Supply current is varied under external resistor control. Peak power is not reduced at any listed current. Similar results can be obtained for other frequency bands.

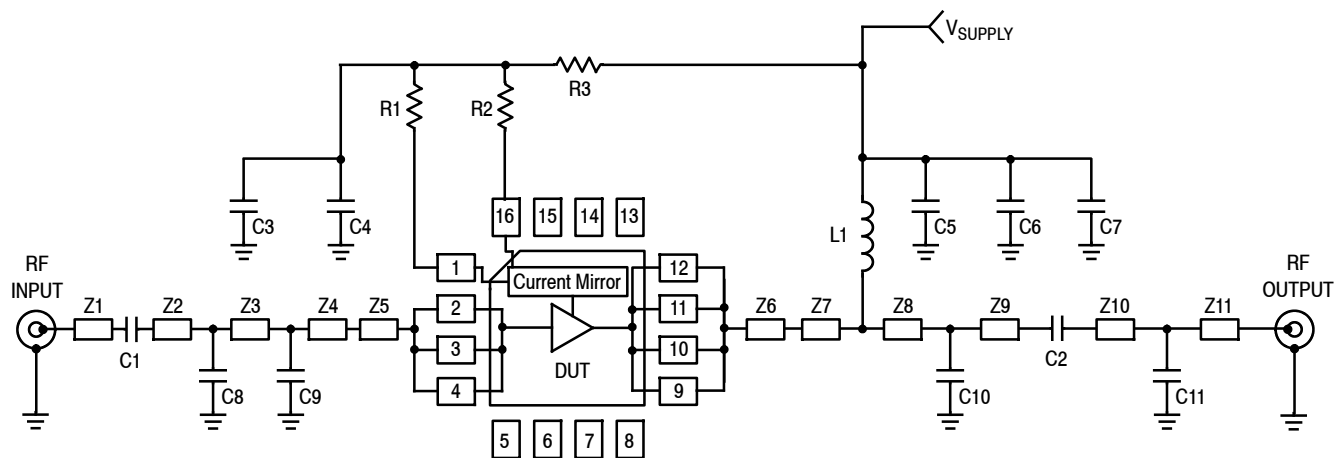
**Figure 2. Third Order Output Intercept Point versus Output Power and Supply Current**



NOTE: The MTTF is calculated with V<sub>DC</sub> = 5 Vdc, I<sub>DC</sub> = 850 mA

**Figure 3. MTTF versus Junction Temperature**

### 50 OHM APPLICATION CIRCUIT: 900 MHz



|             |                            |     |   |
|-------------|----------------------------|-----|---|
| Z1          | 0.140" x 0.028" Microstrip | Z6  | 0.026" x 0.089" Microstrip              |
| Z2, Z9, Z10 | 0.044" x 0.028" Microstrip | Z7  | 0.167" x 0.028" Microstrip              |
| Z3          | 0.169" x 0.028" Microstrip | Z8  | 0.178" x 0.028" Microstrip              |
| Z4          | 0.177" x 0.028" Microstrip | Z11 | 0.096" x 0.028" Microstrip              |
| Z5          | 0.026" x 0.053" Microstrip | PCB | Isola FR408, 0.014", $\epsilon_r = 3.7$ |

**Figure 4. 50 Ohm Test Circuit Schematic**

**Table 9. 50 Ohm Test Circuit Component Designations and Values**

| Part    | Description                        | Part Number      | Manufacturer |
|---------|------------------------------------|------------------|--------------|
| C1, C2  | 15 pF Chip Capacitors              | ECUV1H150JCV     | Panasonic    |
| C3, C6  | 0.01 $\mu$ F Chip Capacitors       | C0603C103J5RAC   | Kemet        |
| C4, C7  | 0.1 $\mu$ F Chip Capacitors        | C0603C104J5RAC   | Kemet        |
| C5      | 2.2 $\mu$ F Chip Capacitor         | T491A225K016AT   | Kemet        |
| C8      | 6.8 pF Chip Capacitor              | 06035J6R8BS      | AVX          |
| C9, C11 | 3.9 pF Chip Capacitors             | 06035J3R9BS      | AVX          |
| C10     | 5.6 pF Chip Capacitor              | 06035J5R6BS      | AVX          |
| L1      | 15 nH Chip Inductor                | 1008CS-150XJB    | Coilcraft    |
| R1      | 100 $\Omega$ , 1/4 W Chip Resistor | ERJ8GEYJ101V     | Panasonic    |
| R2, R3  | 0 $\Omega$ , 1/10 W Chip Resistors | CRCW06030000FKEA | Vishay       |

### 50 OHM APPLICATION CIRCUIT: 900 MHz

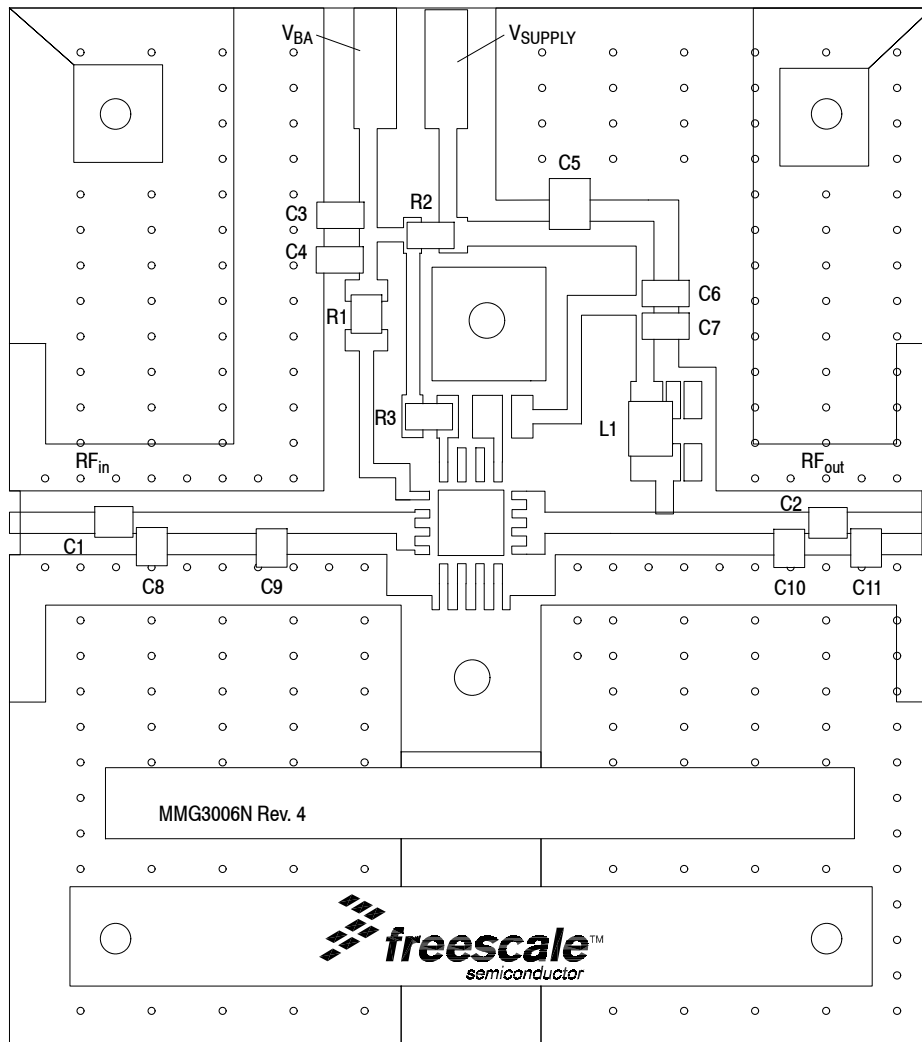
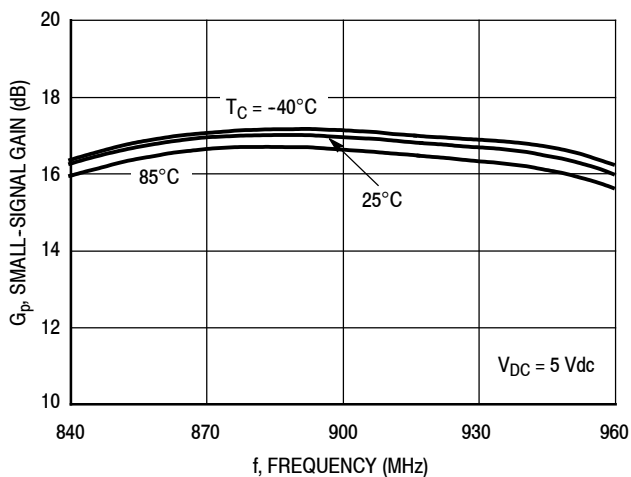
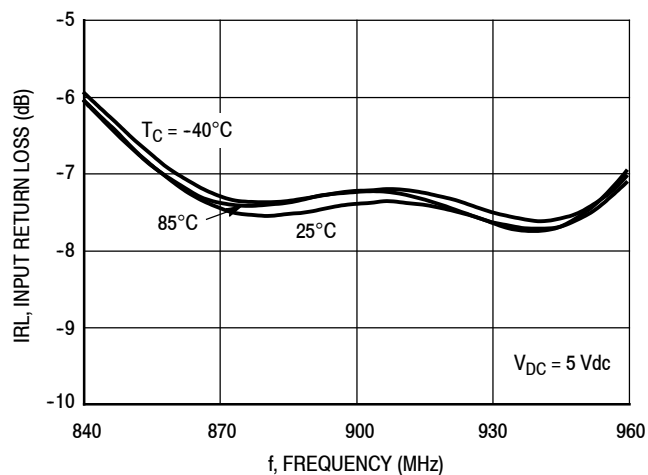


Figure 5. 50 Ohm Test Circuit Component Layout

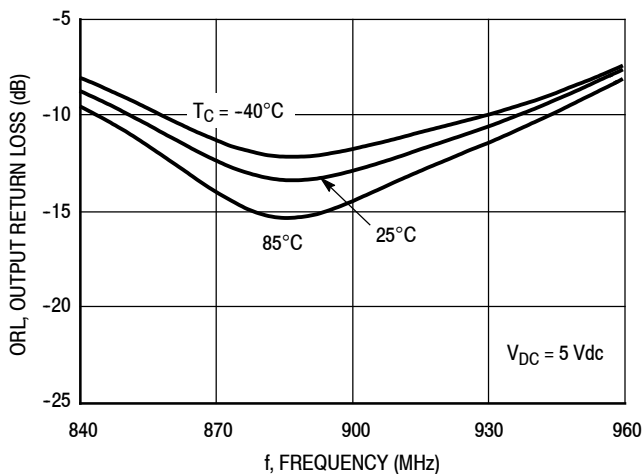
## 50 OHM TYPICAL CHARACTERISTICS: 900 MHz



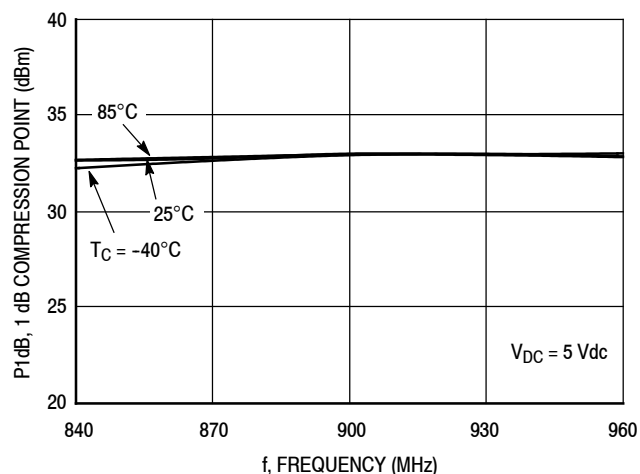
**Figure 6. Small-Signal Gain (S21) versus Frequency**



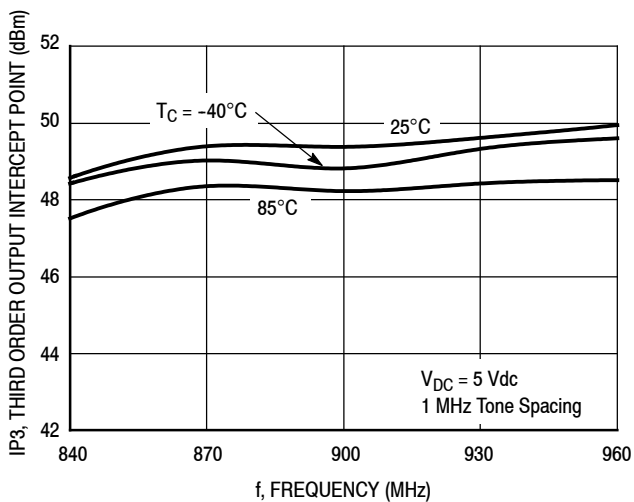
**Figure 7. Input Return Loss (S11) versus Frequency**



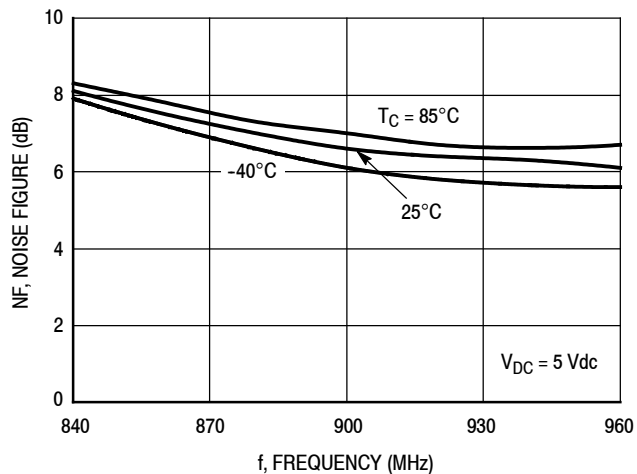
**Figure 8. Output Return Loss (S22) versus Frequency**



**Figure 9. P1dB versus Frequency**

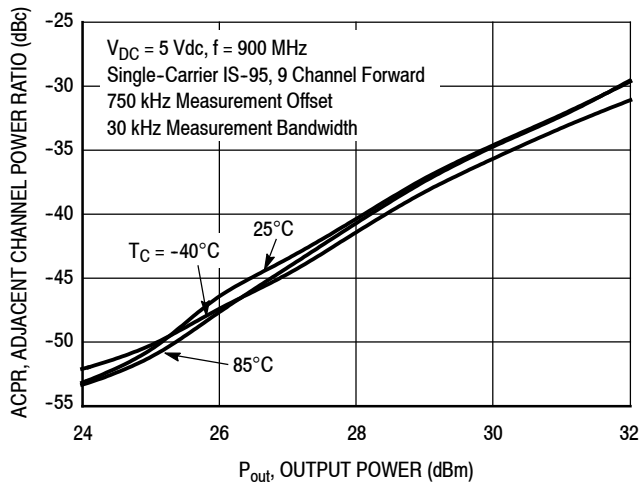


**Figure 10. Third Order Output Intercept Point versus Frequency**

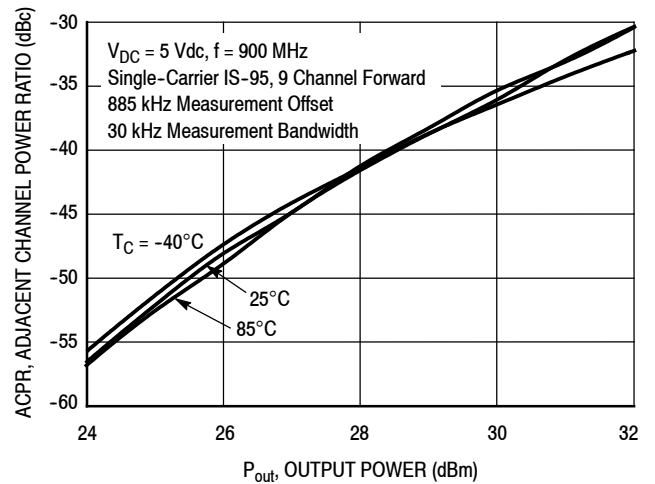


**Figure 11. Noise Figure versus Frequency**

## 50 OHM TYPICAL CHARACTERISTICS: 900 MHz

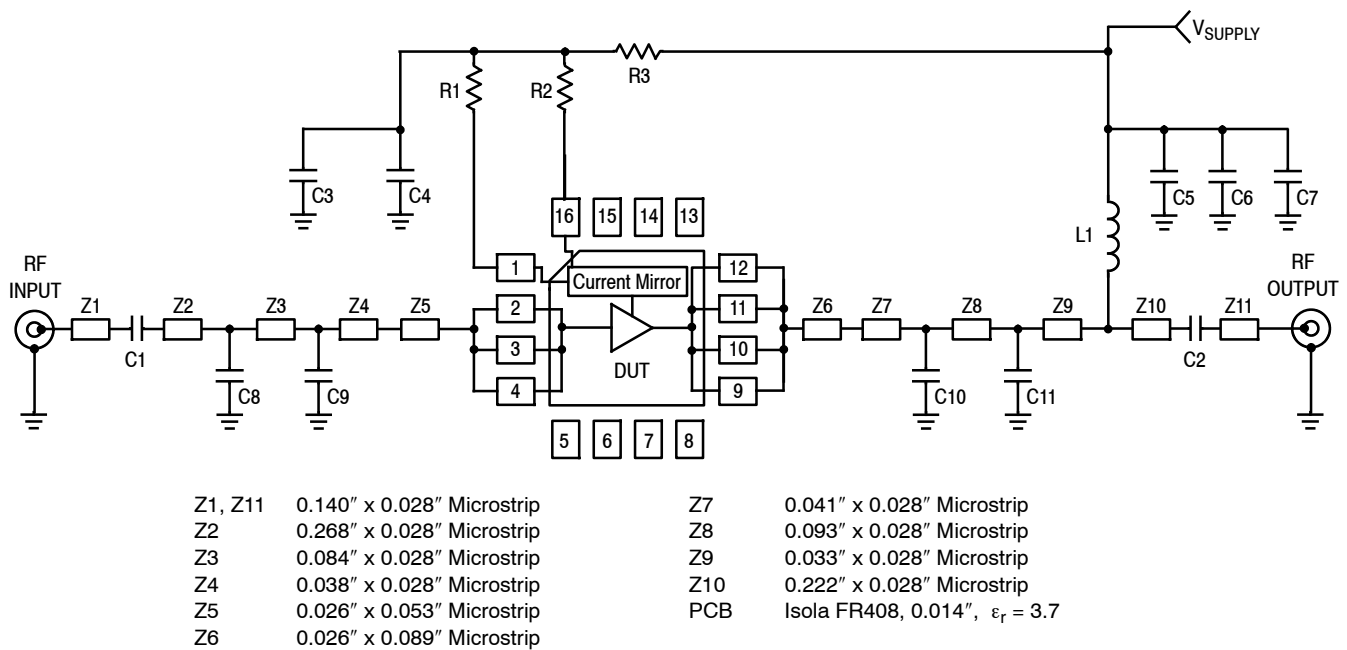


**Figure 12. IS-95 Adjacent Channel Power Ratio versus Output Power**



**Figure 13. IS-95 Adjacent Channel Power Ratio versus Output Power**

## 50 OHM APPLICATION CIRCUIT: 1960 MHz



**Figure 14. 50 Ohm Test Circuit Schematic**

**Table 10. 50 Ohm Test Circuit Component Designations and Values**

| Part   | Description                        | Part Number      | Manufacturer |
|--------|------------------------------------|------------------|--------------|
| C1, C2 | 15 pF Chip Capacitors              | ECUV1H150JCV     | Panasonic    |
| C3, C6 | 0.01 $\mu$ F Chip Capacitors       | C0603C103J5RAC   | Kemet        |
| C4, C7 | 0.1 $\mu$ F Chip Capacitors        | C0603C104J5RAC   | Kemet        |
| C5     | 2.2 $\mu$ F Chip Capacitor         | T491A225K016AT   | Kemet        |
| C8, C9 | 3.0 pF Chip Capacitors             | 06035J3R0BS      | AVX          |
| C10    | 2.0 pF Chip Capacitor              | 06035J2R0BS      | AVX          |
| C11    | 2.7 pF Chip Capacitor              | 06035J2R7BS      | AVX          |
| L1     | 15 nH Chip Inductor                | 1008CS-150XJB    | Coilcraft    |
| R1     | 100 $\Omega$ , 1/4 W Chip Resistor | ERJ8GEYJ101V     | Panasonic    |
| R2, R3 | 0 $\Omega$ , 1/10 W Chip Resistors | CRCW06030000FKEA | Vishay       |



# 50 OHM APPLICATION CIRCUIT: 1960 MHz

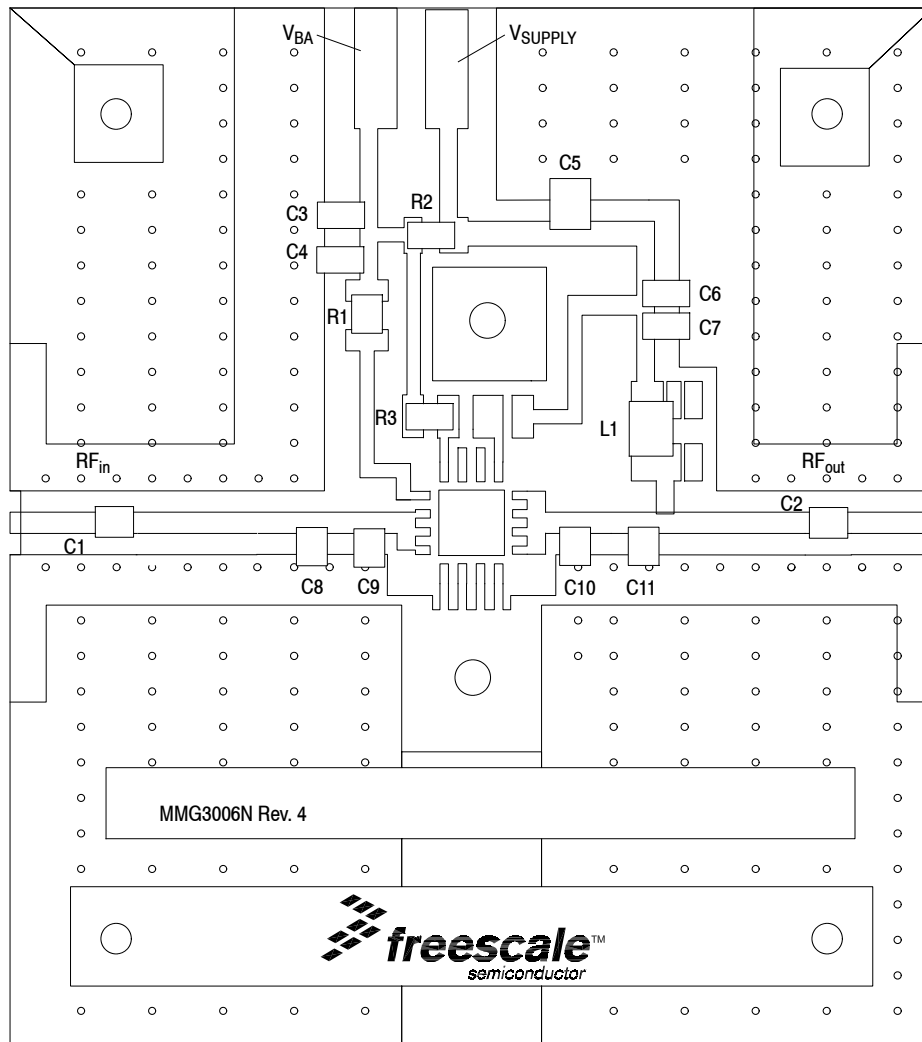
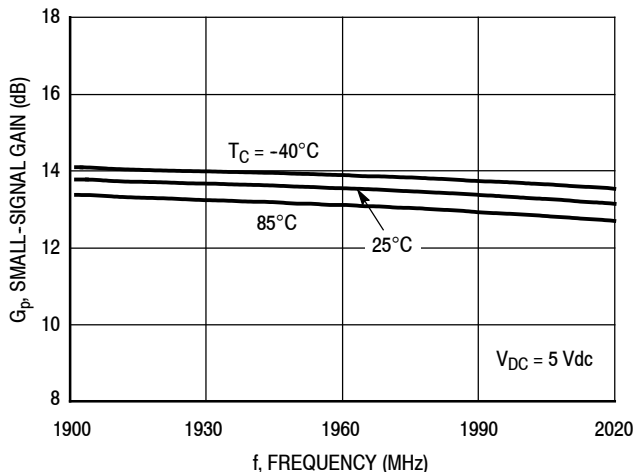
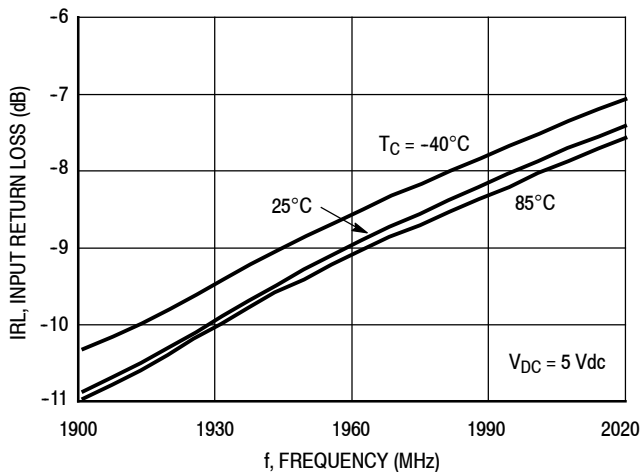


Figure 15. 50 Ohm Test Circuit Component Layout

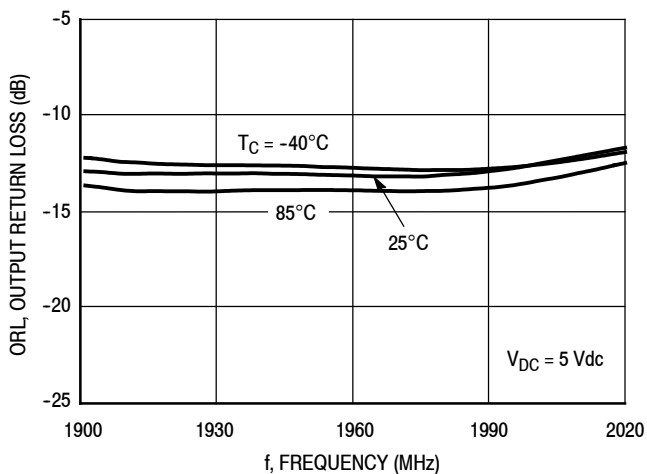
### 50 OHM TYPICAL CHARACTERISTICS: 1960 MHz



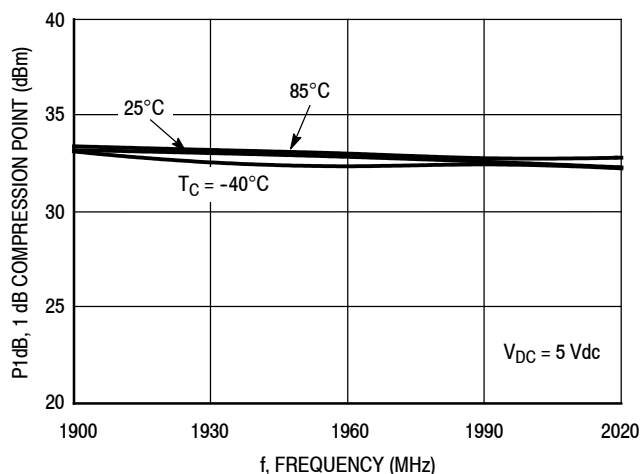
**Figure 16. Small-Signal Gain (S21) versus Frequency**



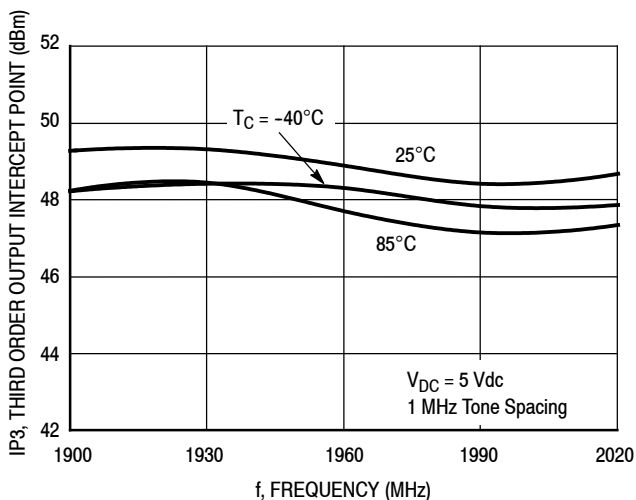
**Figure 17. Input Return Loss (S11) versus Frequency**



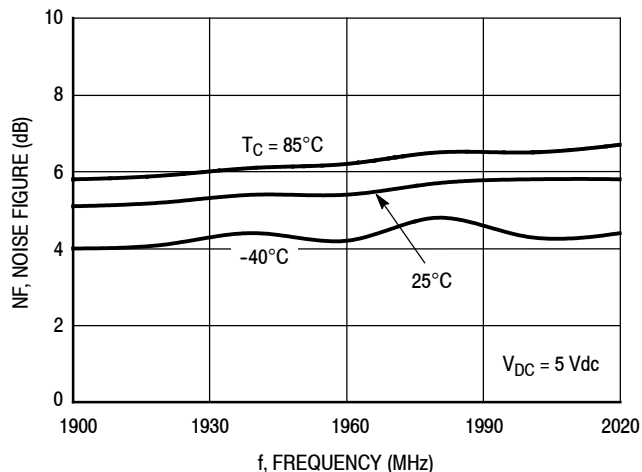
**Figure 18. Output Return Loss (S22) versus Frequency**



**Figure 19. P1dB versus Frequency**

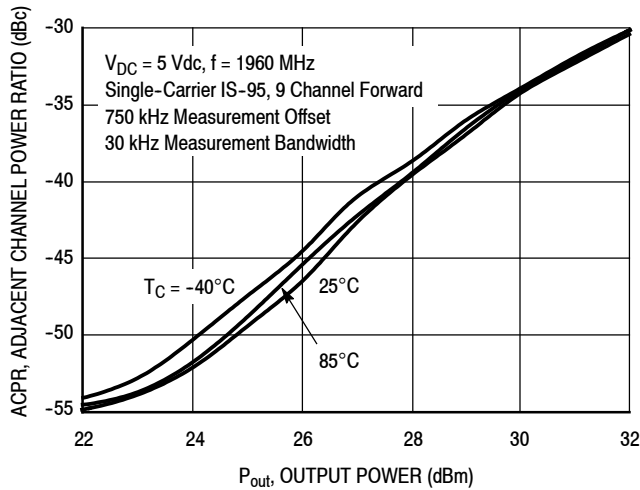


**Figure 20. Third Order Output Intercept Point versus Frequency**

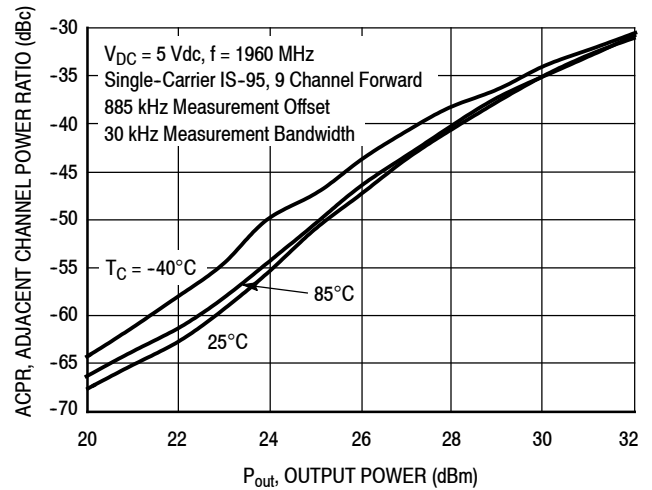


**Figure 21. Noise Figure versus Frequency**

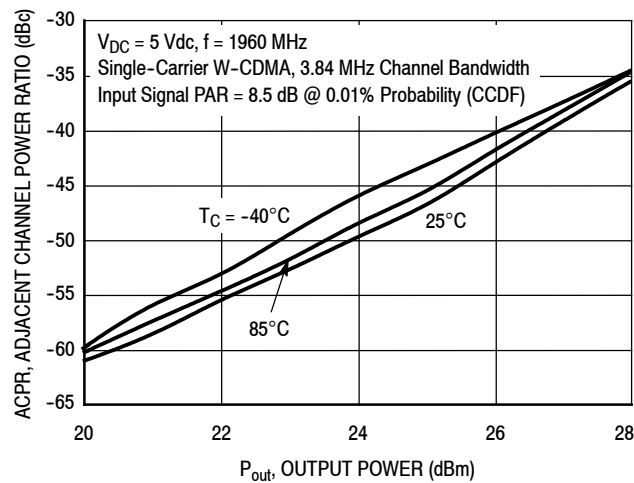
## 50 OHM TYPICAL CHARACTERISTICS: 1960 MHz



**Figure 22. IS-95 Adjacent Channel Power Ratio versus Output Power**

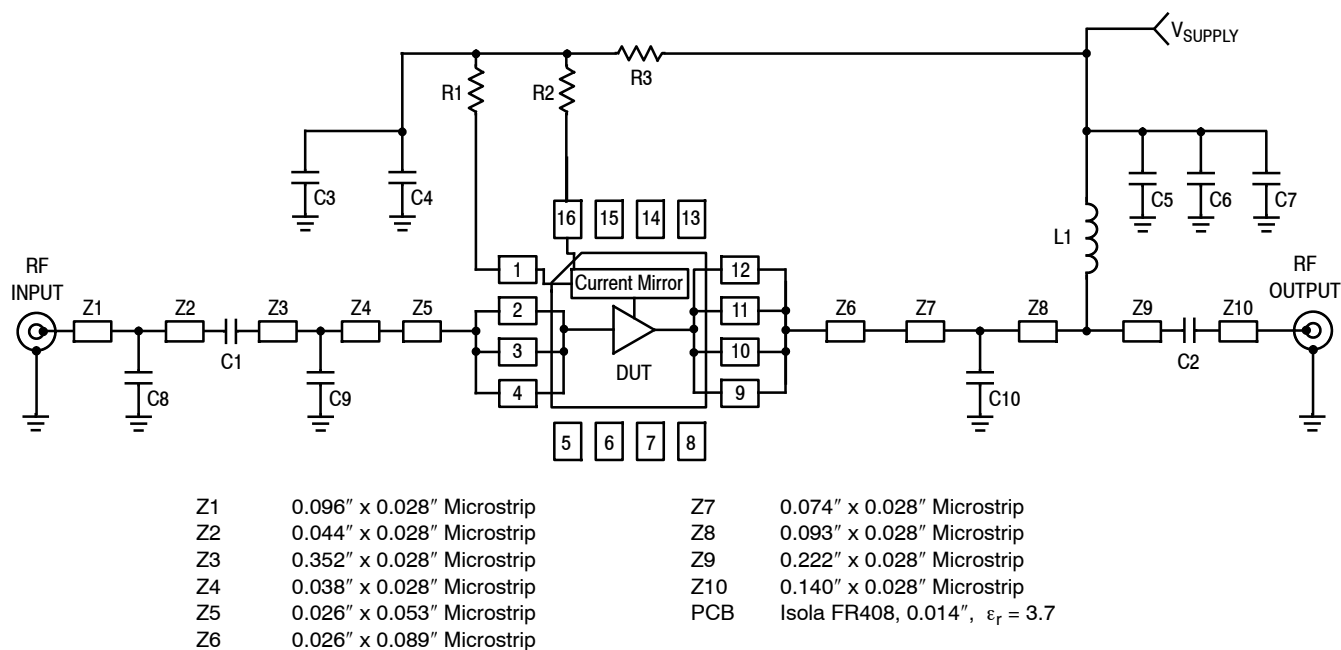


**Figure 23. IS-95 Adjacent Channel Power Ratio versus Output Power**



**Figure 24. Single-Carrier W-CDMA Adjacent Channel Power Ratio versus Output Power**

## 50 OHM APPLICATION CIRCUIT: 2140 MHz



**Figure 25. 50 Ohm Test Circuit Schematic**

**Table 11. 50 Ohm Test Circuit Component Designations and Values**

| Part   | Description                        | Part Number      | Manufacturer |
|--------|------------------------------------|------------------|--------------|
| C1, C2 | 15 pF Chip Capacitors              | ECUV1H150JCV     | Panasonic    |
| C3, C6 | 0.01 $\mu$ F Chip Capacitors       | C0603C103J5RAC   | Kemet        |
| C4, C7 | 0.1 $\mu$ F Chip Capacitors        | C0603C104J5RAC   | Kemet        |
| C5     | 2.2 $\mu$ F Chip Capacitor         | T491A225K016AT   | Kemet        |
| C8     | 0.5 pF Chip Capacitor              | 06035J0R5BS      | AVX          |
| C9     | 3.6 pF Chip Capacitor              | 06035J3R6BS      | AVX          |
| C10    | 3.9 pF Chip Capacitor              | 06035J3R9BS      | AVX          |
| L1     | 15 nH Chip Inductor                | 1008CS-150XJB    | Coilcraft    |
| R1     | 100 $\Omega$ , 1/4 W Chip Resistor | ERJ8GEYJ101V     | Panasonic    |
| R2, R3 | 0 $\Omega$ , 1/10 W Chip Resistors | CRCW06030000FKEA | Vishay       |

### 50 OHM APPLICATION CIRCUIT: 2140 MHz

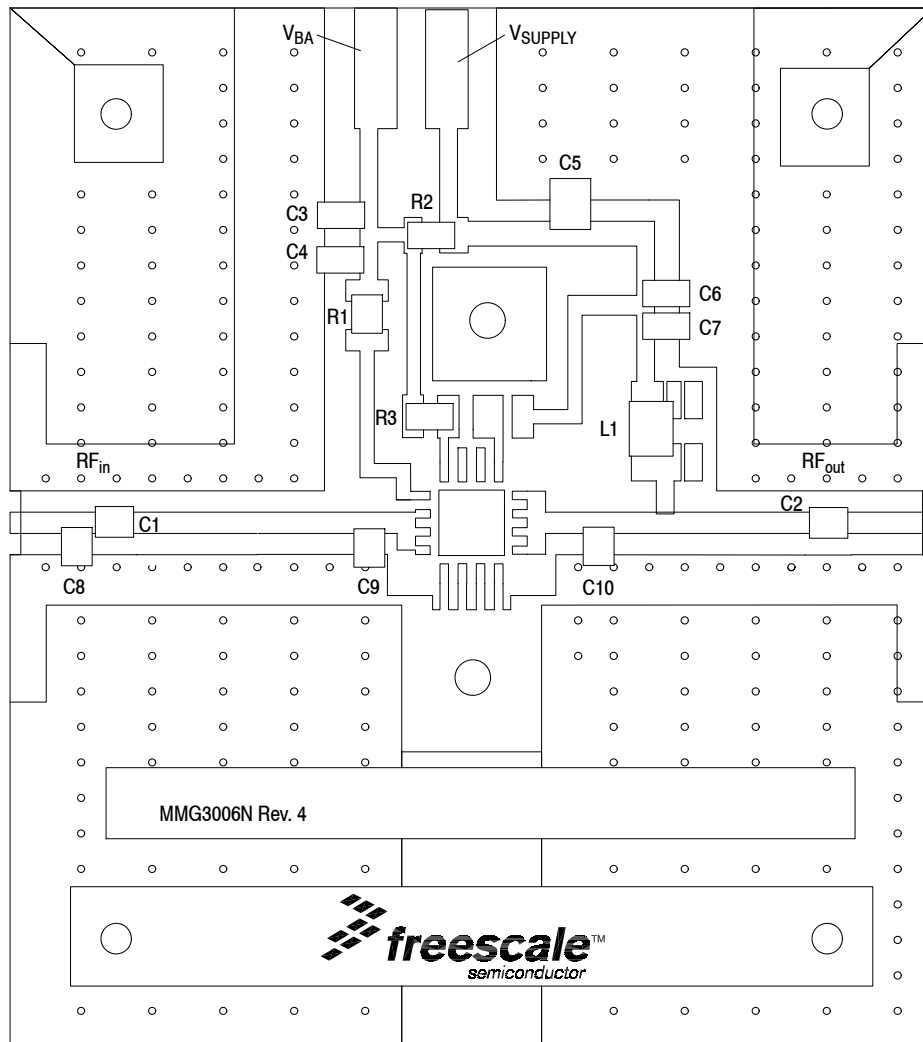


Figure 26. 50 Ohm Test Circuit Component Layout

50 OHM TYPICAL CHARACTERISTICS: 2140 MHz

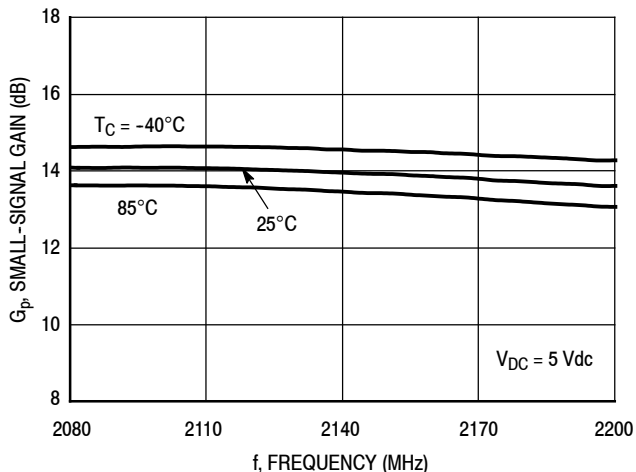


Figure 27. Small-Signal Gain (S21) versus Frequency

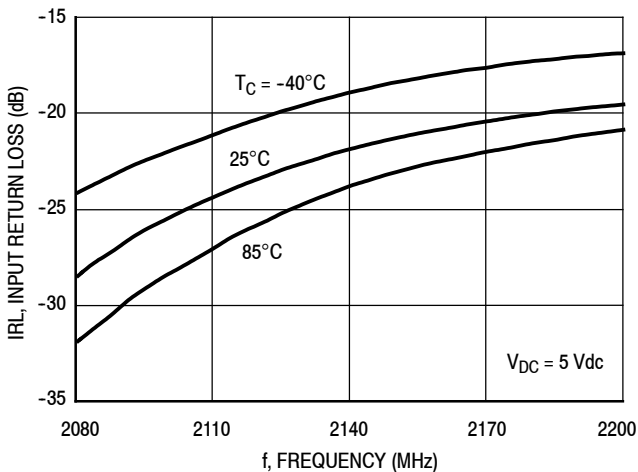


Figure 28. Input Return Loss (S11) versus Frequency

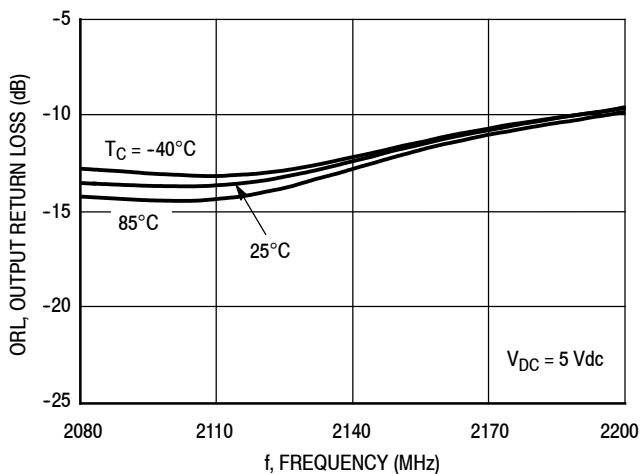


Figure 29. Output Return Loss (S22) versus Frequency

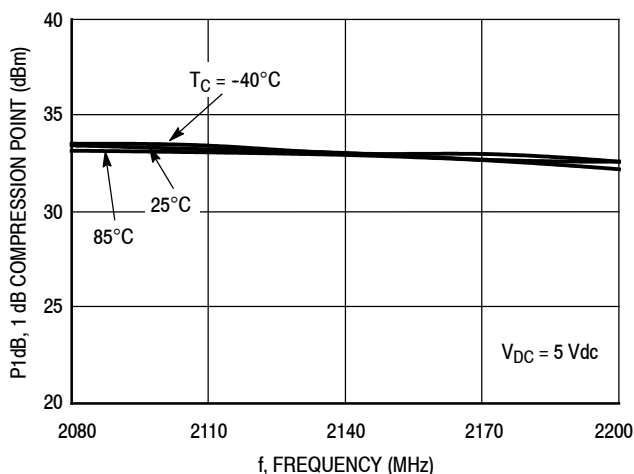


Figure 30. P1dB versus Frequency

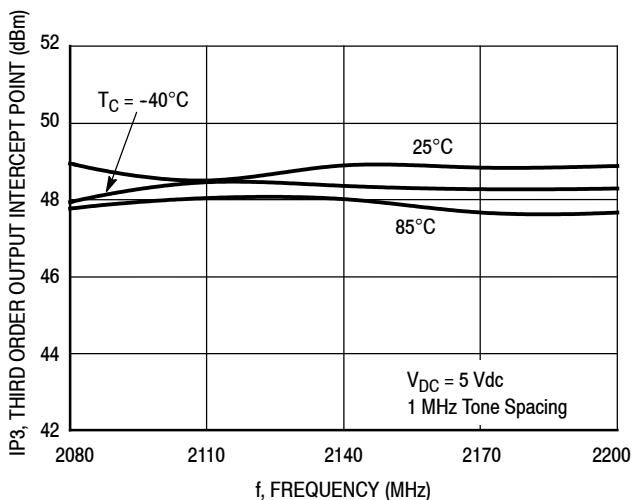


Figure 31. Third Order Output Intercept Point versus Frequency

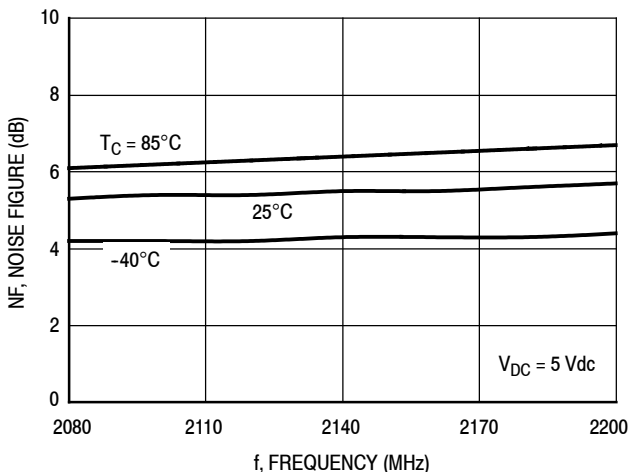


Figure 32. Noise Figure versus Frequency

50 OHM TYPICAL CHARACTERISTICS: 2140 MHz

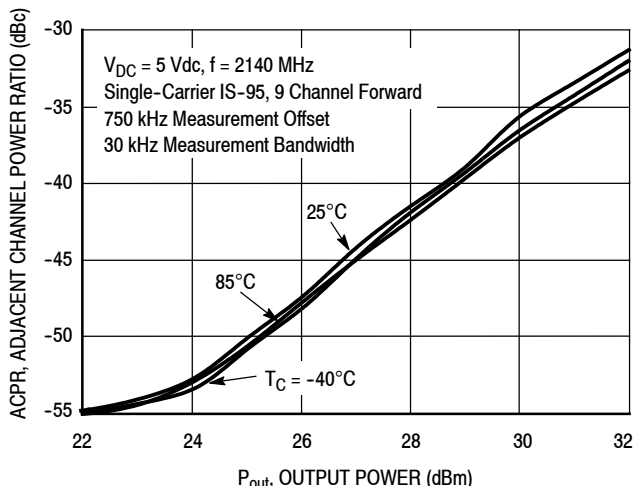


Figure 33. IS-95 Adjacent Channel Power Ratio versus Output Power

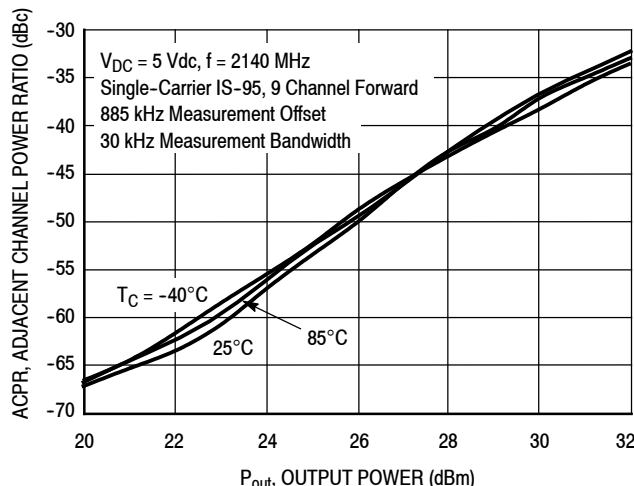


Figure 34. IS-95 Adjacent Channel Power Ratio versus Output Power

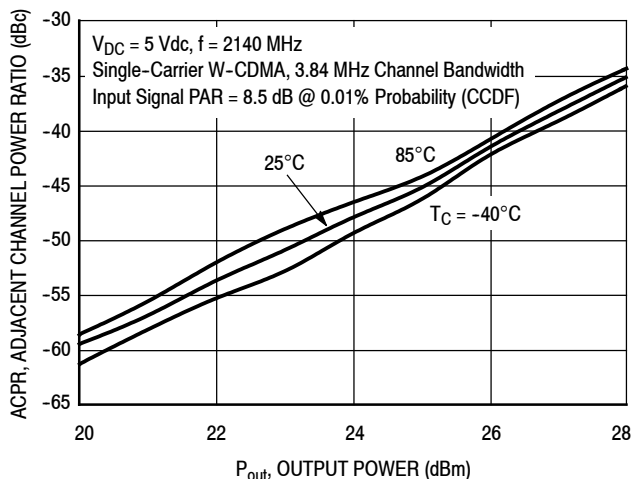


Figure 35. Single-Carrier W-CDMA Adjacent Channel Power Ratio versus Output Power

## 50 OHM TYPICAL CHARACTERISTICS

**Table 12. Common Emitter S-Parameters** ( $V_{DC} = 5 \text{ Vdc}$ ,  $T_A = 25^\circ\text{C}$ , 50 Ohm System)

| f<br>MHz | S <sub>11</sub> |        | S <sub>21</sub> |       | S <sub>12</sub> |       | S <sub>22</sub> |        |
|----------|-----------------|--------|-----------------|-------|-----------------|-------|-----------------|--------|
|          | S <sub>11</sub> | ∠ φ    | S <sub>21</sub> | ∠ φ   | S <sub>12</sub> | ∠ φ   | S <sub>22</sub> | ∠ φ    |
| 250      | 0.821           | -173.7 | 2.816           | 143.3 | 0.00597         | -61.7 | 0.922           | -179.0 |
| 300      | 0.841           | -174.5 | 2.643           | 137.3 | 0.00514         | -56.7 | 0.922           | -178.9 |
| 350      | 0.860           | -175.2 | 2.471           | 132.0 | 0.00455         | -51.6 | 0.922           | -179.1 |
| 400      | 0.872           | -175.3 | 2.309           | 127.6 | 0.00435         | -44.2 | 0.921           | -180.0 |
| 450      | 0.889           | -176.1 | 2.149           | 124.2 | 0.00371         | -46.7 | 0.924           | -179.4 |
| 500      | 0.900           | -177.0 | 2.030           | 120.3 | 0.00331         | -40.6 | 0.924           | -179.6 |
| 550      | 0.909           | -177.9 | 1.908           | 116.9 | 0.00306         | -35.3 | 0.925           | -179.4 |
| 600      | 0.917           | -178.8 | 1.796           | 113.8 | 0.00286         | -30.6 | 0.925           | -179.4 |
| 650      | 0.924           | -179.6 | 1.695           | 110.8 | 0.00269         | -25.9 | 0.924           | -179.6 |
| 700      | 0.930           | 179.6  | 1.605           | 108.2 | 0.00258         | -20.7 | 0.923           | -179.5 |
| 750      | 0.935           | 178.9  | 1.522           | 105.8 | 0.00248         | -15.9 | 0.922           | -179.6 |
| 800      | 0.939           | 178.2  | 1.448           | 103.4 | 0.00243         | -11.1 | 0.921           | -179.8 |
| 850      | 0.943           | 177.5  | 1.380           | 101.3 | 0.00240         | -6.6  | 0.920           | -179.9 |
| 900      | 0.946           | 176.9  | 1.320           | 99.2  | 0.00239         | -2.2  | 0.919           | 180.0  |
| 950      | 0.949           | 176.3  | 1.266           | 97.2  | 0.00239         | 1.8   | 0.918           | 179.9  |
| 1000     | 0.951           | 175.7  | 1.216           | 95.2  | 0.00242         | 5.4   | 0.918           | 179.6  |
| 1050     | 0.953           | 175.2  | 1.172           | 93.4  | 0.00246         | 8.8   | 0.918           | 179.5  |
| 1100     | 0.954           | 174.6  | 1.133           | 91.5  | 0.00250         | 11.9  | 0.917           | 179.3  |
| 1150     | 0.956           | 174.1  | 1.098           | 89.7  | 0.00255         | 14.1  | 0.917           | 179.0  |
| 1200     | 0.957           | 173.6  | 1.067           | 87.8  | 0.00261         | 16.7  | 0.916           | 178.8  |
| 1250     | 0.958           | 173.1  | 1.039           | 86.0  | 0.00268         | 18.6  | 0.915           | 178.6  |
| 1300     | 0.958           | 172.6  | 1.015           | 84.3  | 0.00275         | 19.9  | 0.915           | 178.3  |
| 1350     | 0.958           | 172.2  | 0.994           | 82.4  | 0.00282         | 21.4  | 0.914           | 177.9  |
| 1400     | 0.959           | 171.7  | 0.978           | 80.5  | 0.00292         | 22.6  | 0.913           | 177.6  |
| 1450     | 0.958           | 171.3  | 0.964           | 78.5  | 0.00299         | 23.5  | 0.913           | 177.3  |
| 1500     | 0.957           | 170.9  | 0.952           | 76.5  | 0.00306         | 23.9  | 0.912           | 177.1  |
| 1550     | 0.957           | 170.5  | 0.945           | 74.3  | 0.00316         | 24.2  | 0.912           | 176.7  |
| 1600     | 0.955           | 170.0  | 0.941           | 72.0  | 0.00324         | 24.3  | 0.911           | 176.5  |
| 1650     | 0.954           | 169.7  | 0.941           | 69.6  | 0.00332         | 23.7  | 0.910           | 176.2  |
| 1700     | 0.951           | 169.2  | 0.944           | 67.0  | 0.00340         | 23.3  | 0.909           | 175.8  |
| 1750     | 0.949           | 168.8  | 0.951           | 64.1  | 0.00348         | 22.3  | 0.907           | 175.5  |
| 1800     | 0.945           | 168.4  | 0.969           | 60.9  | 0.00360         | 21.0  | 0.906           | 175.2  |
| 1850     | 0.942           | 168.1  | 0.975           | 57.4  | 0.00361         | 19.4  | 0.905           | 175.0  |
| 1900     | 0.937           | 167.7  | 0.985           | 53.5  | 0.00364         | 16.9  | 0.903           | 174.6  |
| 1950     | 0.932           | 167.3  | 0.999           | 49.0  | 0.00363         | 14.0  | 0.902           | 174.4  |
| 2000     | 0.925           | 166.9  | 1.016           | 43.7  | 0.00357         | 9.9   | 0.901           | 174.1  |
| 2050     | 0.918           | 166.4  | 1.034           | 37.5  | 0.00346         | 5.4   | 0.902           | 173.8  |
| 2100     | 0.910           | 166.0  | 1.048           | 30.2  | 0.00322         | -0.4  | 0.903           | 173.4  |
| 2150     | 0.904           | 165.6  | 1.053           | 21.7  | 0.00290         | -6.9  | 0.905           | 173.2  |
| 2200     | 0.900           | 165.2  | 1.038           | 11.9  | 0.00242         | -13.5 | 0.910           | 172.9  |
| 2250     | 0.902           | 164.9  | 0.995           | 1.2   | 0.00178         | -19.1 | 0.916           | 172.5  |
| 2300     | 0.910           | 164.4  | 0.922           | -10.0 | 0.00104         | -18.2 | 0.925           | 172.2  |
| 2350     | 0.924           | 164.1  | 0.823           | -20.9 | 0.000474        | 24.3  | 0.933           | 171.9  |

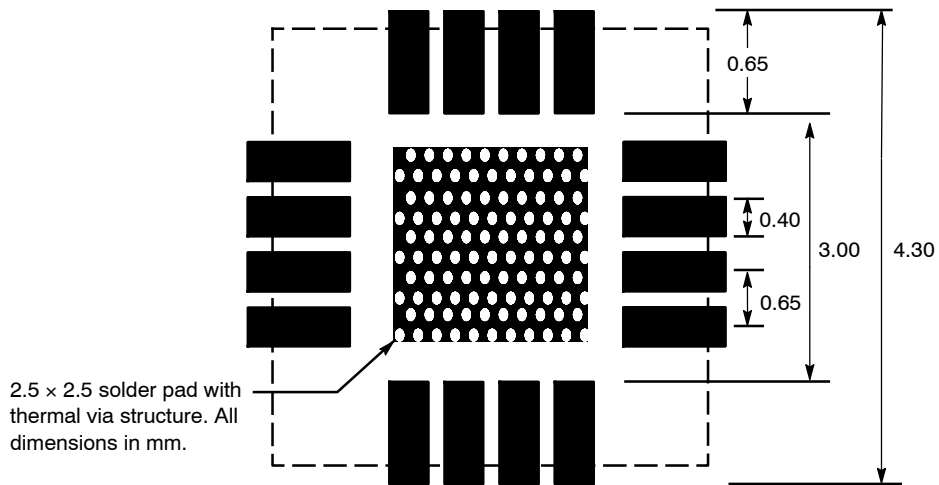
(continued)



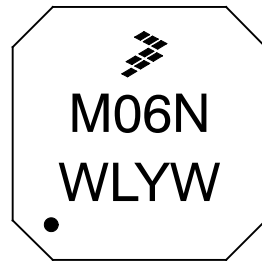
## 50 OHM TYPICAL CHARACTERISTICS

**Table 12. Common Emitter S-Parameters** ( $V_{DC} = 5 \text{ Vdc}$ ,  $T_A = 25^\circ\text{C}$ , 50 Ohm System) (continued)

| f<br>MHz | S <sub>11</sub> |       | S <sub>21</sub> |       | S <sub>12</sub> |      | S <sub>22</sub> |       |
|----------|-----------------|-------|-----------------|-------|-----------------|------|-----------------|-------|
|          | S <sub>11</sub> | ∠ φ   | S <sub>21</sub> | ∠ φ   | S <sub>12</sub> | ∠ φ  | S <sub>22</sub> | ∠ φ   |
| 2400     | 0.938           | 163.7 | 0.711           | -30.9 | 0.000864        | 82.0 | 0.938           | 171.7 |
| 2450     | 0.952           | 163.3 | 0.600           | -39.7 | 0.00152         | 86.3 | 0.943           | 171.4 |
| 2500     | 0.963           | 162.9 | 0.498           | -47.0 | 0.00207         | 84.0 | 0.945           | 171.1 |
| 2550     | 0.970           | 162.5 | 0.408           | -53.1 | 0.00253         | 80.0 | 0.946           | 170.8 |
| 2600     | 0.976           | 162.1 | 0.332           | -58.0 | 0.00287         | 76.4 | 0.947           | 170.4 |
| 2650     | 0.981           | 161.6 | 0.268           | -61.9 | 0.00316         | 73.4 | 0.945           | 169.0 |
| 2700     | 0.983           | 161.2 | 0.215           | -64.8 | 0.00340         | 71.2 | 0.944           | 168.3 |
| 2750     | 0.986           | 160.8 | 0.170           | -66.7 | 0.00361         | 69.2 | 0.943           | 167.4 |
| 2800     | 0.988           | 160.5 | 0.132           | -67.6 | 0.00382         | 67.5 | 0.941           | 166.5 |
| 2850     | 0.988           | 160.0 | 0.101           | -66.9 | 0.00402         | 66.1 | 0.940           | 165.9 |
| 2900     | 0.989           | 159.6 | 0.075           | -64.1 | 0.00418         | 64.8 | 0.939           | 165.1 |
| 2950     | 0.990           | 159.2 | 0.053           | -57.4 | 0.00438         | 63.4 | 0.938           | 164.5 |
| 3000     | 0.990           | 158.8 | 0.037           | -43.3 | 0.00455         | 62.3 | 0.937           | 163.9 |

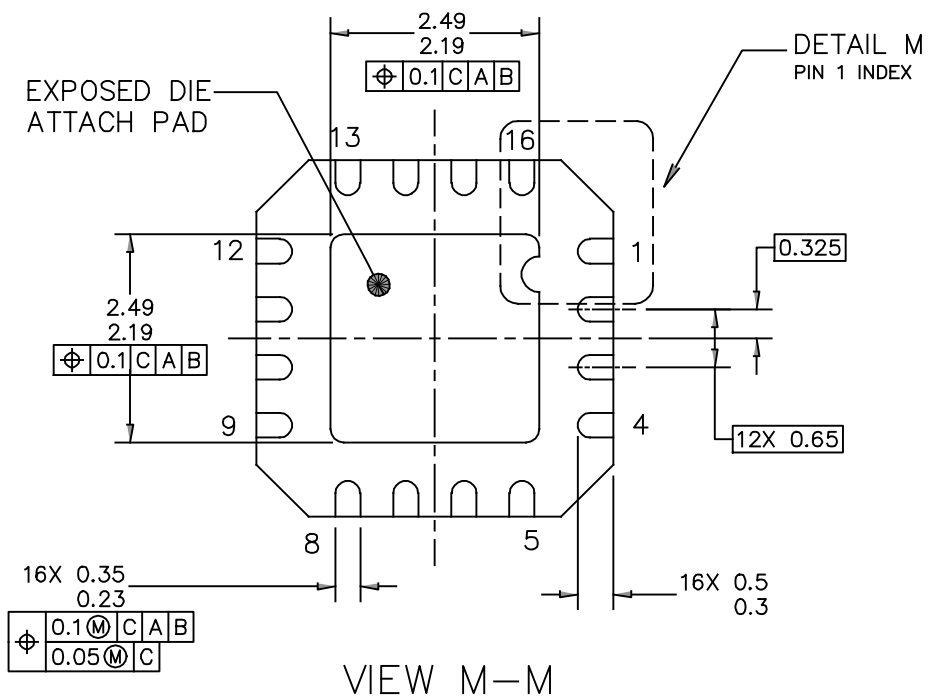
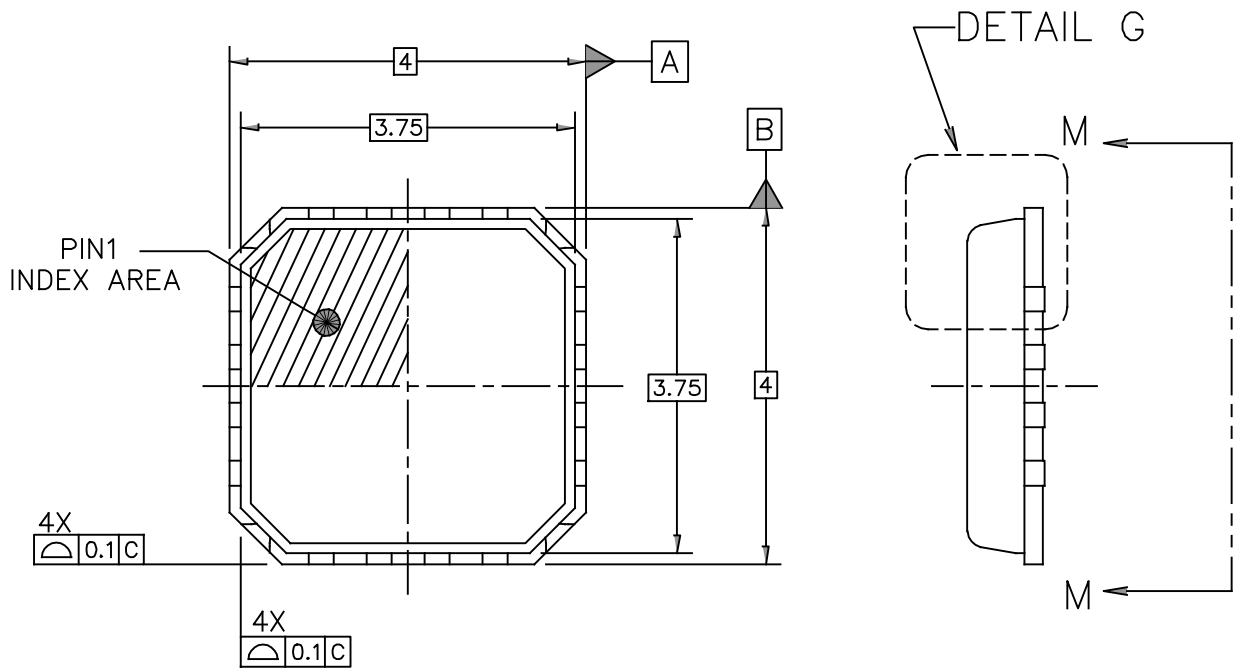


**Figure 36. PCB Pad Layout for 16-Lead QFN 4 x 4**



**Figure 37. Product Marking**

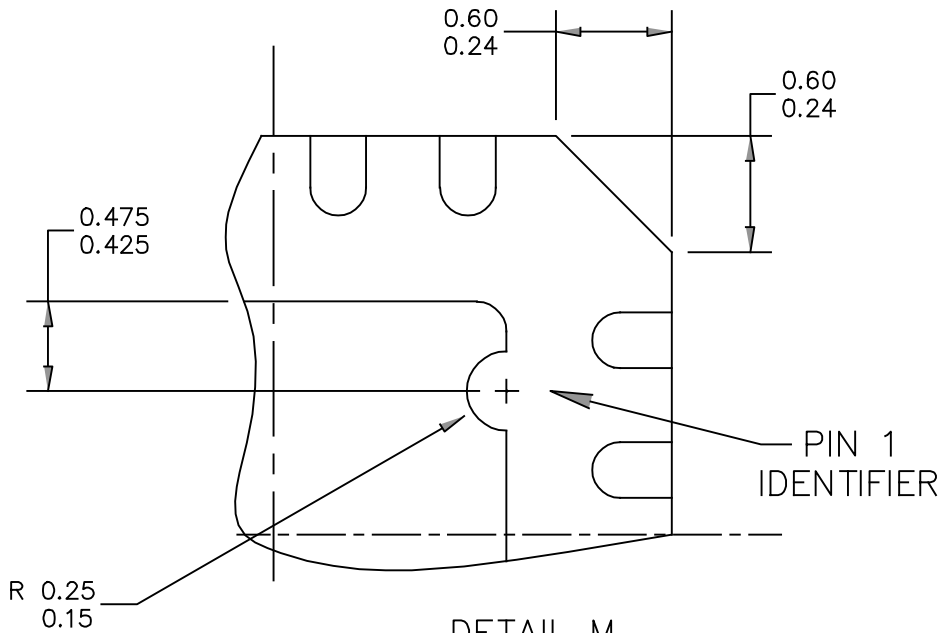
## PACKAGE DIMENSIONS



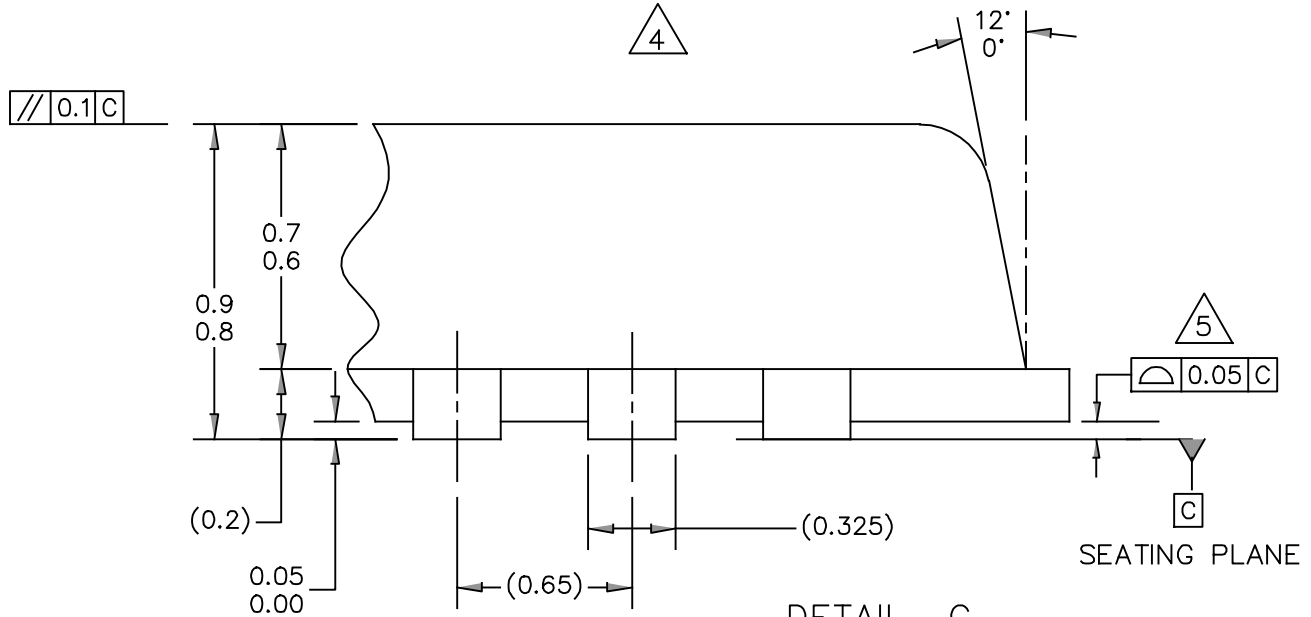
VIEW M-M

|  |                                      |                            |
|--|--------------------------------------|----------------------------|
| © NXP SEMICONDUCTORS N.V.<br>ALL RIGHTS RESERVED   | MECHANICAL OUTLINE                   | PRINT VERSION NOT TO SCALE |
| TITLE: THERMALLY ENHANCED QUAD<br>FLAT NON-LEADED PACKAGE (QFN)<br>16 TERMINAL, 0.65 PITCH (4 X 4 X 0.9) | DOCUMENT NO: 98ASA10761D      REV: C |                            |
|  | STANDARD: NON-JEDEC                  |                            |
|  | SOT1592-1                            | 14 MAR 2016                |

MMG3006NT1



DETAIL M  
PIN 1 BACKSIDE IDENTIFIER



DETAIL G  
VIEW ROTATED 90° CW

|  |                          |                            |
|--|--------------------------|----------------------------|
| © NXP SEMICONDUCTORS N.V.<br>ALL RIGHTS RESERVED   | MECHANICAL OUTLINE       | PRINT VERSION NOT TO SCALE |
| TITLE: THERMALLY ENHANCED QUAD<br>FLAT NON-LEADED PACKAGE (QFN)<br>16 TERMINAL, 0.65 PITCH (4 X 4 X 0.9) | DOCUMENT NO: 98ASA10761D | REV: C                     |
|  | STANDARD: NON-JEDEC      |                            |
|  | SOT1592-1                | 14 MAR 2016                |

NOTES:

1. ALL DIMENSIONS ARE IN MILLIMETERS.
2. DIMENSIONING AND TOLERANCING PER ASME Y14.5M-1994.
3. THE COMPLETE JEDEC DESIGNATOR FOR THIS PACKAGE IS: HF-PQFN.
4. DIMENSIONS OF OPTIONAL FEATURES ARE FOR REFERENCE ONLY.
5. COPLANARITY APPLIES TO LEADS, CORNER LEADS, AND DIE ATTACH PAD.
6. MIN METAL GAP SHOULD BE 0.25MM.

|   |                    |                            |             |
|---|--------------------|----------------------------|-------------|
| © NXP SEMICONDUCTORS N.V.<br>ALL RIGHTS RESERVED  | MECHANICAL OUTLINE | PRINT VERSION NOT TO SCALE |             |
| TITLE:<br>THERMALLY ENHANCED QUAD<br>FLAT NON-LEADED PACKAGE (QFN)<br>16 TERMINAL, 0.65 PITCH (4 X 4 X 0.9) |                    | DOCUMENT NO: 98ASA10761D   | REV: C      |
|   |                    | STANDARD: NON-JEDEC        |             |
|   |                    | SOT1592-1                  | 14 MAR 2016 |

## PRODUCT DOCUMENTATION, SOFTWARE AND TOOLS

Refer to the following resources to aid your design process.

### Application Notes

- AN1955: Thermal Measurement Methodology of RF Power Amplifiers
- AN3100: General Purpose Amplifier Biasing
- AN3778: PCB Layout Guidelines for PQFN/QFN Style Packages Requiring Thermal Vias for Heat Dissipation

### Software

- .s2p File

### Development Tools

- Printed Circuit Boards

For Software and Tools, do a Part Number search at <http://www.nxp.com>, and select the "Part Number" link. Go to Software & Tools on the part's Product Summary page to download the respective tool.

## FAILURE ANALYSIS

At this time, because of the physical characteristics of the part, failure analysis is limited to electrical signature analysis. In cases where NXP is contractually obligated to perform failure analysis (FA) services, full FA may be performed by third party vendors with moderate success. For updates contact your local NXP Sales Office.

## REVISION HISTORY

The following table summarizes revisions to this document.

| Revision | Date       | Description   |
|----------|------------|---|
| 0        | Jan. 2008  | <ul style="list-style-type: none"><li>• Initial Release of Data Sheet</li></ul>   |
| 1        | Mar. 2008  | <ul style="list-style-type: none"><li>• Corrected Table 7, Moisture Sensitivity Level Rating from 3 to 1, p. 3</li><li>• Corrected S-Parameter table frequency column label to read "MHz" versus "GHz", pp. 17, 18</li></ul>  |
| 2        | Mar. 2008  | <ul style="list-style-type: none"><li>• Corrected Tape and Reel information from 330 mm to 12 mm, p. 1</li><li>• Corrected Figs. 24, 35, Single-Carrier W-CDMA Adjacent Channel Power Ratio versus Output Power y-axis (ACPR) unit of measure to dBc, pp. 12, 16</li></ul>  |
| 3        | May 2010   | <ul style="list-style-type: none"><li>• Added new Fig. 3, Third Order Output Intercept Point versus Output Power and Supply Current, p. 4</li><li>• Added AN3778, PCB Layout Guidelines for PQFN/QFN Style Packages Requiring Thermal Vias for Heat Dissipation, Application Notes, p. 23</li><li>• Added .s2p File availability to Product Software, p. 23</li></ul>   |
| 4        | Jan. 2011  | <ul style="list-style-type: none"><li>• Corrected temperature at which Theta<sub>JC</sub> is measured from 25°C to 89°C and added "no RF applied" to Thermal Characteristics table to indicate that thermal characterization is performed under DC test with no RF signal applied, p. 1</li><li>• Removed I<sub>DC</sub> bias callout from Table 10, Common Source S-Parameters heading as bias is not a controlled value, pp. 17-18</li><li>• Added Printed Circuit Boards availability to Development Tools, p. 23</li></ul>  |
| 5        | Sept. 2014 | <ul style="list-style-type: none"><li>• Table 2, Maximum Ratings: updated Junction Temperature from 150°C to 175°C to reflect recent test results of the device, p. 1</li><li>• Table 6, ESD Protection Characteristics, removed the word "Minimum" after the ESD class rating. ESD ratings are characterized during new product development but are not 100% tested during production. ESD ratings provided in the data sheet are intended to be used as a guideline when handling ESD sensitive devices, p. 2</li><li>• Removed Fig. 2, Collector Current versus Bias Voltage at Pin #1, p. 3</li><li>• Added Fig. 38, Product Marking, p. 18</li><li>• Added Failure Analysis information, p. 22</li></ul> |

(continued)

## REVISION HISTORY (cont.)

| Revision | Date      | Description   |
|----------|-----------|---|
| 6        | Dec. 2017 | <ul style="list-style-type: none"><li>Fig. 37, Product Marking: updated to show location of Pin 1 on Product Marking and updated date code line to reflect improved traceability information, p. 18</li></ul> |