

# MUN2113, MMUN2113L, MUN5113, DTA144EE, DTA144EM3, NSBA144EF3

## Digital Transistors (BRT) R1 = 47 kΩ, R2 = 47 kΩ

### PNP Transistors with Monolithic Bias Resistor Network

This series of digital transistors is designed to replace a single device and its external resistor bias network. The Bias Resistor Transistor (BRT) contains a single transistor with a monolithic bias network consisting of two resistors; a series base resistor and a base-emitter resistor. The BRT eliminates these individual components by integrating them into a single device. The use of a BRT can reduce both system cost and board space.

#### Features

- Simplifies Circuit Design
- Reduces Board Space
- Reduces Component Count
- S and NSV Prefix for Automotive and Other Applications Requiring Unique Site and Control Change Requirements; AEC-Q101 Qualified and PPAP Capable
- These Devices are Pb-Free, Halogen Free/BFR Free and are RoHS Compliant

#### MAXIMUM RATINGS (T<sub>A</sub> = 25°C)

Rating	Symbol	Max	Unit
Collector-Base Voltage	V <sub>CBO</sub>	50	Vdc
Collector-Emitter Voltage	V <sub>CEO</sub>	50	Vdc
Collector Current - Continuous	I <sub>C</sub>	100	mAdc
Input Forward Voltage	V <sub>IN(fwd)</sub>	40	Vdc
Input Reverse Voltage	V <sub>IN(rev)</sub>	10	Vdc

Stresses exceeding those listed in the Maximum Ratings table may damage the device. If any of these limits are exceeded, device functionality should not be assumed, damage may occur and reliability may be affected.



ON Semiconductor®

[www.onsemi.com](http://www.onsemi.com)

#### PIN CONNECTIONS

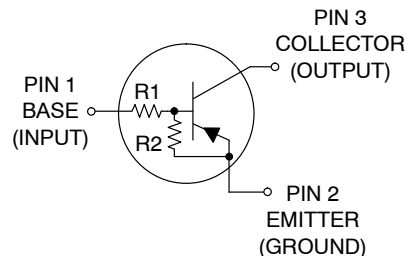

#### MARKING DIAGRAMS

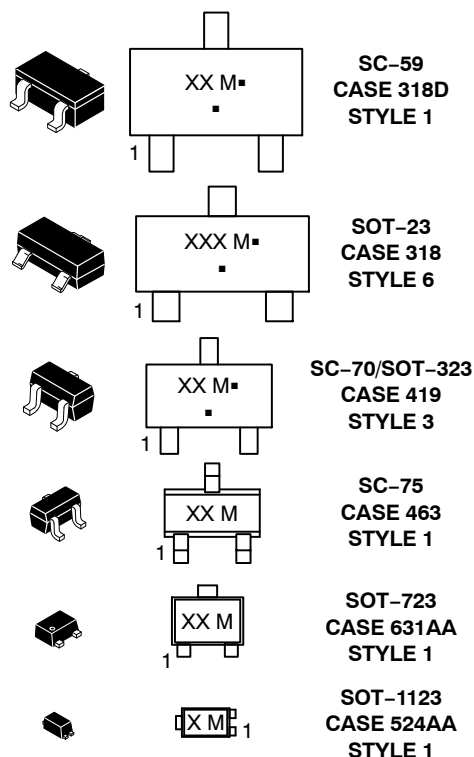

XXX = Specific Device Code  
M = Date Code\*  
▪ = Pb-Free Package

(Note: Microdot may be in either location)

\*Date Code orientation may vary depending upon manufacturing location.

#### ORDERING INFORMATION

See detailed ordering, marking, and shipping information in the package dimensions section on page 2 of this data sheet.

# MUN2113, MMUN2113L, MUN5113, DTA144EE, DTA144EM3, NSBA144EF3

**Table 1. ORDERING INFORMATION**

Device	Part Marking	Package	Shipping†
MUN2113T1G, SMUN2113T1G*	6C	SC-59 (Pb-Free)	3000 / Tape & Reel
MMUN2113LT1G, SMMUN2113LT1G*	A6C	SOT-23 (Pb-Free)	3000 / Tape & Reel
MMUN2113LT3G, NSVMMUN2113LT3G*	A6C	SOT-23 (Pb-Free)	10000 / Tape & Reel
MUN5113T1G, SMUN5113T1G*	6C	SC-70/SOT-323 (Pb-Free)	3000 / Tape & Reel
MUN5113T3G	6C	SC-70/SOT-323 (Pb-Free)	10000 / Tape & Reel
DTA144EET1G, NSVDTA144EET1G*	6C	SC-75 (Pb-Free)	3000 / Tape & Reel
DTA144EM3T5G	6C	SOT-723 (Pb-Free)	8000 / Tape & Reel
NSBA144EF3T5G	E	SOT-1123 (Pb-Free)	8000 / Tape & Reel

†For information on tape and reel specifications, including part orientation and tape sizes, please refer to our Tape and Reel Packaging Specifications Brochure, BRD8011/D.

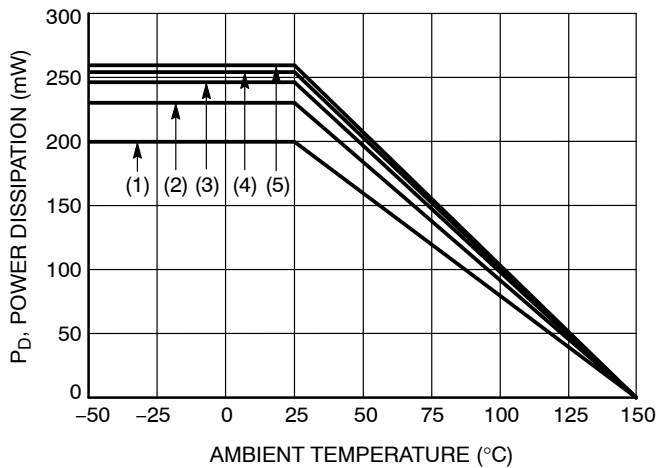

- (1) SC-75 and SC-70/SOT-323; Minimum Pad
- (2) SC-59; Minimum Pad
- (3) SOT-23; Minimum Pad
- (4) SOT-1123; 100 mm<sup>2</sup>, 1 oz. copper trace
- (5) SOT-723; Minimum Pad

**Figure 1. Derating Curve**

**MUN2113, MMUN2113L, MUN5113, DTA144EE, DTA144EM3, NSBA144EF3**

**Table 2. THERMAL CHARACTERISTICS**

Characteristic	Symbol	Max	Unit
<b>THERMAL CHARACTERISTICS (SC-59) (MUN2113)</b>			
Total Device Dissipation $T_A = 25^\circ\text{C}$ (Note 1) (Note 2) Derate above $25^\circ\text{C}$ (Note 1) (Note 2)	$P_D$	230 338 1.8 2.7	mW  mW/ $^\circ\text{C}$
Thermal Resistance, Junction to Ambient (Note 1) (Note 2)	$R_{\theta JA}$	540 370	$^\circ\text{C}/\text{W}$
Thermal Resistance, Junction to Lead (Note 1) (Note 2)	$R_{\theta JL}$	264 287	$^\circ\text{C}/\text{W}$
Junction and Storage Temperature Range	$T_J, T_{stg}$	-55 to +150	$^\circ\text{C}$

**THERMAL CHARACTERISTICS (SOT-23) (MMUN2113L)**

Total Device Dissipation $T_A = 25^\circ\text{C}$ (Note 1) (Note 2) Derate above $25^\circ\text{C}$ (Note 1) (Note 2)	$P_D$	246 400 2.0 3.2	mW  mW/ $^\circ\text{C}$
Thermal Resistance, Junction to Ambient (Note 1) (Note 2)	$R_{\theta JA}$	508 311	$^\circ\text{C}/\text{W}$
Thermal Resistance, Junction to Lead (Note 1) (Note 2)	$R_{\theta JL}$	174 208	$^\circ\text{C}/\text{W}$
Junction and Storage Temperature Range	$T_J, T_{stg}$	-55 to +150	$^\circ\text{C}$

**THERMAL CHARACTERISTICS (SC-70/SOT-323) (MUN5113)**

Total Device Dissipation $T_A = 25^\circ\text{C}$ (Note 1) (Note 2) Derate above $25^\circ\text{C}$ (Note 1) (Note 2)	$P_D$	202 310 1.6 2.5	mW  mW/ $^\circ\text{C}$
Thermal Resistance, Junction to Ambient (Note 1) (Note 2)	$R_{\theta JA}$	618 403	$^\circ\text{C}/\text{W}$
Thermal Resistance, Junction to Lead (Note 1) (Note 2)	$R_{\theta JL}$	280 332	$^\circ\text{C}/\text{W}$
Junction and Storage Temperature Range	$T_J, T_{stg}$	-55 to +150	$^\circ\text{C}$

**THERMAL CHARACTERISTICS (SC-75) (DTA144EE)**

Total Device Dissipation $T_A = 25^\circ\text{C}$ (Note 1) (Note 2) Derate above $25^\circ\text{C}$ (Note 1) (Note 2)	$P_D$	200 300 1.6 2.4	mW  mW/ $^\circ\text{C}$
Thermal Resistance, Junction to Ambient (Note 1) (Note 2)	$R_{\theta JA}$	600 400	$^\circ\text{C}/\text{W}$
Junction and Storage Temperature Range	$T_J, T_{stg}$	-55 to +150	$^\circ\text{C}$

**THERMAL CHARACTERISTICS (SOT-723) (DTA144EM3)**

Total Device Dissipation $T_A = 25^\circ\text{C}$ (Note 1) (Note 2) Derate above $25^\circ\text{C}$ (Note 1) (Note 2)	$P_D$	260 600 2.0 4.8	mW  mW/ $^\circ\text{C}$
Thermal Resistance, Junction to Ambient (Note 1) (Note 2)	$R_{\theta JA}$	480 205	$^\circ\text{C}/\text{W}$
Junction and Storage Temperature Range	$T_J, T_{stg}$	-55 to +150	$^\circ\text{C}$

- FR-4 @ Minimum Pad.
- FR-4 @ 1.0 x 1.0 Inch Pad.
- FR-4 @ 100 mm<sup>2</sup>, 1 oz. copper traces, still air.
- FR-4 @ 500 mm<sup>2</sup>, 1 oz. copper traces, still air.

# MUN2113, MMUN2113L, MUN5113, DTA144EE, DTA144EM3, NSBA144EF3

**Table 2. THERMAL CHARACTERISTICS**

Characteristic	Symbol	Max	Unit
<b>THERMAL CHARACTERISTICS (SOT-1123) (NSBA144EF3)</b>			
Total Device Dissipation $T_A = 25^\circ\text{C}$ (Note 3) (Note 4) Derate above $25^\circ\text{C}$ (Note 3) (Note 4)	$P_D$	254 297 2.0 2.4	mW mW/ $^\circ\text{C}$
Thermal Resistance, Junction to Ambient (Note 3) (Note 4)	$R_{\theta JA}$	493 421	$^\circ\text{C}/\text{W}$
Thermal Resistance, Junction to Lead (Note 3)	$R_{\theta JL}$	193	$^\circ\text{C}/\text{W}$
Junction and Storage Temperature Range	$T_J, T_{stg}$	-55 to +150	$^\circ\text{C}$

- FR-4 @ Minimum Pad.
- FR-4 @ 1.0 x 1.0 Inch Pad.
- FR-4 @ 100 mm<sup>2</sup>, 1 oz. copper traces, still air.
- FR-4 @ 500 mm<sup>2</sup>, 1 oz. copper traces, still air.

**Table 3. ELECTRICAL CHARACTERISTICS** ( $T_A = 25^\circ\text{C}$ , unless otherwise noted)

Characteristic	Symbol	Min	Typ	Max	Unit
<b>OFF CHARACTERISTICS</b>					
Collector-Base Cutoff Current ( $V_{CB} = 50\text{ V}, I_E = 0$ )	$I_{CBO}$	-	-	100	nAdc
Collector-Emitter Cutoff Current ( $V_{CE} = 50\text{ V}, I_B = 0$ )	$I_{CEO}$	-	-	500	nAdc
Emitter-Base Cutoff Current ( $V_{EB} = 6.0\text{ V}, I_C = 0$ )	$I_{EBO}$	-	-	0.1	mAdc
Collector-Base Breakdown Voltage ( $I_C = 10\ \mu\text{A}, I_E = 0$ )	$V_{(BR)CBO}$	50	-	-	Vdc
Collector-Emitter Breakdown Voltage (Note 5) ( $I_C = 2.0\text{ mA}, I_B = 0$ )	$V_{(BR)CEO}$	50	-	-	Vdc
<b>ON CHARACTERISTICS</b>					
DC Current Gain (Note 5) ( $I_C = 5.0\text{ mA}, V_{CE} = 10\text{ V}$ )	$h_{FE}$	80	140	-	
Collector-Emitter Saturation Voltage (Note 5) ( $I_C = 10\text{ mA}, I_B = 0.3\text{ mA}$ )	$V_{CE(sat)}$	-	-	0.25	Vdc
Input Voltage (off) ( $V_{CE} = 5.0\text{ V}, I_C = 100\ \mu\text{A}$ )	$V_{i(off)}$	-	1.2	0.8	Vdc
Input Voltage (on) ( $V_{CE} = 0.3\text{ V}, I_C = 2.0\text{ mA}$ )	$V_{i(on)}$	3.0	1.6	-	Vdc
Output Voltage (on) ( $V_{CC} = 5.0\text{ V}, V_B = 3.5\text{ V}, R_L = 1.0\text{ k}\Omega$ )	$V_{OL}$	-	-	0.2	Vdc
Output Voltage (off) ( $V_{CC} = 5.0\text{ V}, V_B = 0.5\text{ V}, R_L = 1.0\text{ k}\Omega$ )	$V_{OH}$	4.9	-	-	Vdc
Input Resistor	R1	32.9	47	61.1	k $\Omega$
Resistor Ratio	$R_1/R_2$	0.8	1.0	1.2	

Product parametric performance is indicated in the Electrical Characteristics for the listed test conditions, unless otherwise noted. Product performance may not be indicated by the Electrical Characteristics if operated under different conditions.

- Pulsed Condition: Pulse Width = 300 msec, Duty Cycle  $\leq$  2%.

TYPICAL CHARACTERISTICS  
MUN2113, MMUN2113L, MUN5113, DTA144EE, DTA144EM3

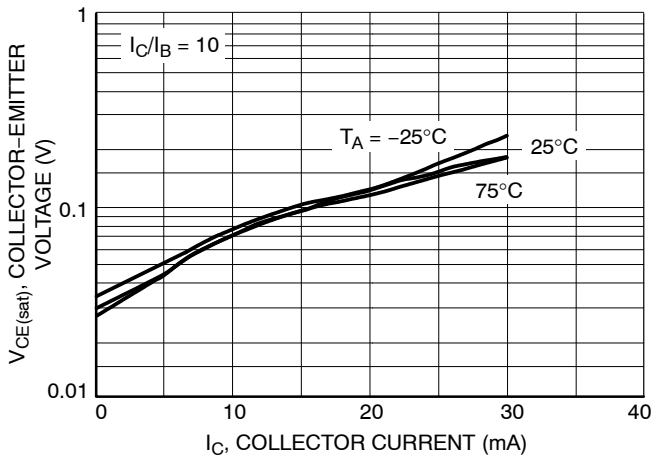

Figure 2.  $V_{CE(sat)}$  vs.  $I_C$

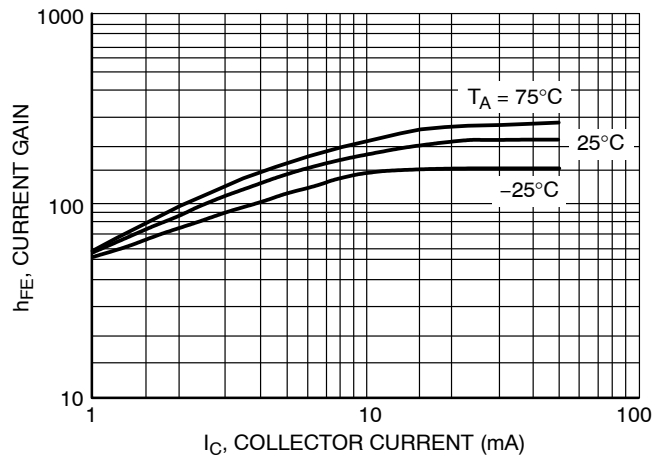

Figure 3. DC Current Gain

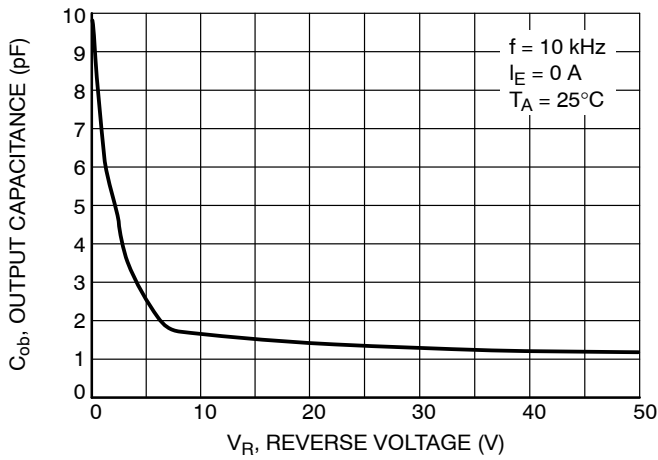

Figure 4. Output Capacitance

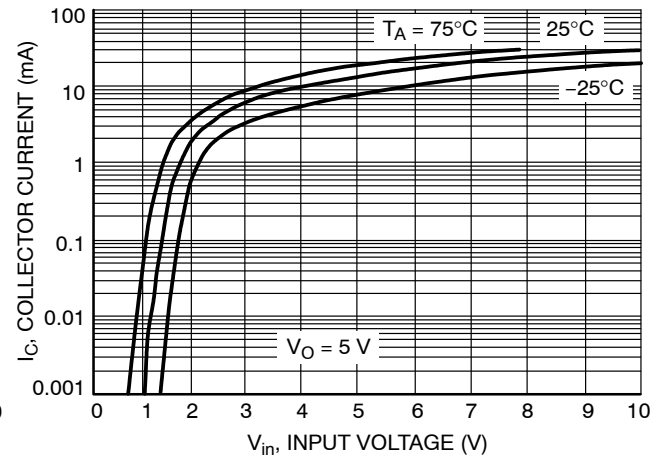

Figure 5. Output Current vs. Input Voltage

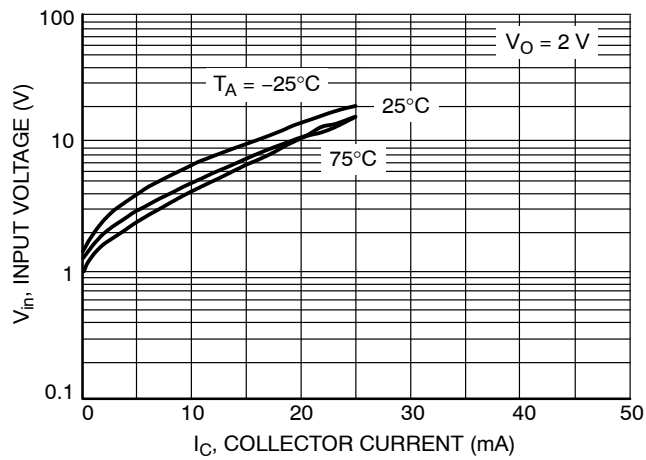

Figure 6. Input Voltage vs. Output Current

TYPICAL CHARACTERISTICS – NSBA144EF3

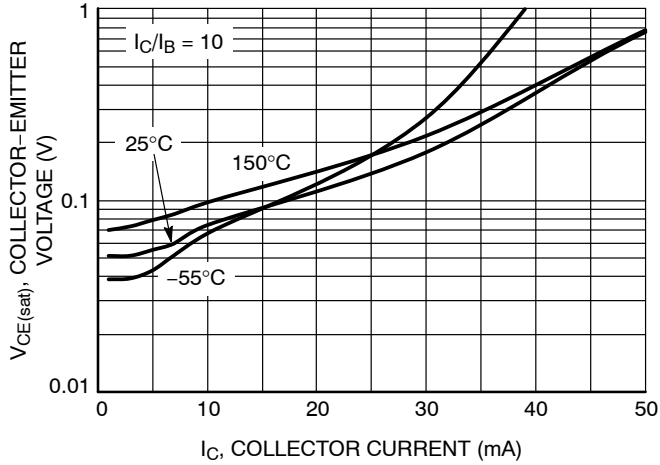

Figure 7.  $V_{CE(sat)}$  vs.  $I_C$

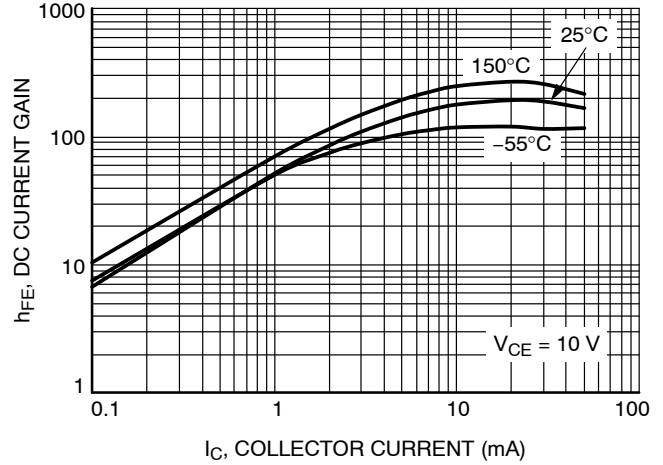

Figure 8. DC Current Gain

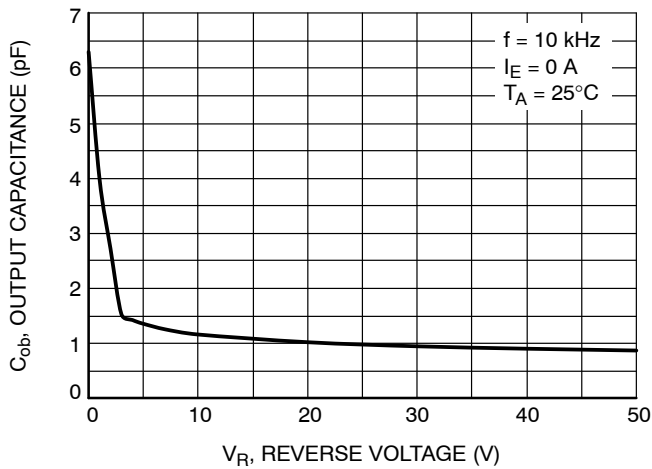

Figure 9. Output Capacitance

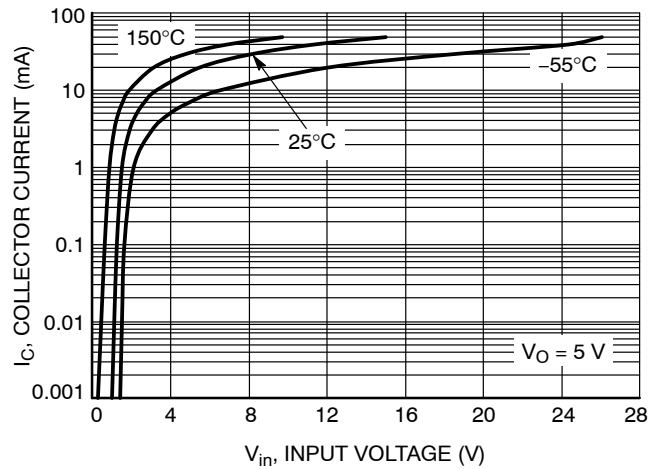

Figure 10. Output Current vs. Input Voltage

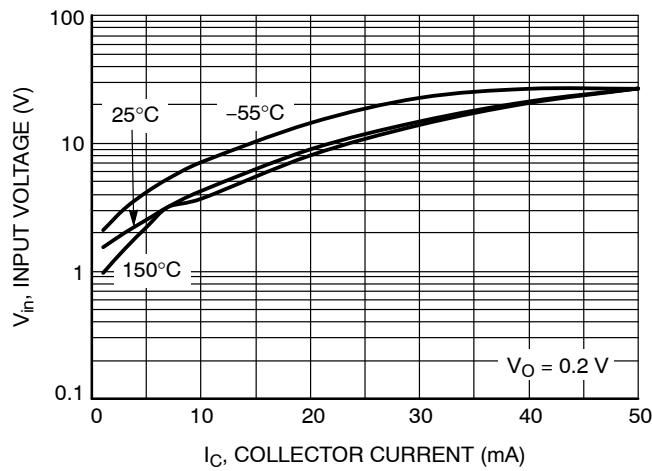

Figure 11. Input Voltage vs. Output Current

# MECHANICAL CASE OUTLINE PACKAGE DIMENSIONS



**SOT-23 (TO-236)**  
CASE 318  
ISSUE AT

DATE 01 MAR 2023

SCALE 4:1



**NOTES:**

1. DIMENSIONING AND TOLERANCING PER ASME Y14.5M,1994.
2. CONTROLLING DIMENSION: MILLIMETERS
3. MAXIMUM LEAD THICKNESS INCLUDES LEAD FINISH. MINIMUM LEAD THICKNESS IS THE MINIMUM THICKNESS OF THE BASE MATERIAL.
4. DIMENSIONS D AND E DO NOT INCLUDE MOLD FLASH, PROTRUSIONS, OR GATE BURRS.

DIM	MILLIMETERS			INCHES		
	MIN.	NOM.	MAX.	MIN.	NOM.	MAX.
A	0.89	1.00	1.11	0.035	0.039	0.044
A1	0.01	0.06	0.10	0.000	0.002	0.004
b	0.37	0.44	0.50	0.015	0.017	0.020
c	0.08	0.14	0.20	0.003	0.006	0.008
D	2.80	2.90	3.04	0.110	0.114	0.120
E	1.20	1.30	1.40	0.047	0.051	0.055
e	1.78	1.90	2.04	0.070	0.075	0.080
L	0.30	0.43	0.55	0.012	0.017	0.022
L1	0.35	0.54	0.69	0.014	0.021	0.027
H <sub>E</sub>	2.10	2.40	2.64	0.083	0.094	0.104
T	0°	---	10°	0°	---	10°

**GENERIC MARKING DIAGRAM\***



- XXX = Specific Device Code
- M = Date Code
- = Pb-Free Package

\*This information is generic. Please refer to device data sheet for actual part marking. Pb-Free indicator, "G" or microdot "▪", may or may not be present. Some products may not follow the Generic Marking.



**RECOMMENDED MOUNTING FOOTPRINT**

\* For additional information on our Pb-Free strategy and soldering details, please download the ON Semiconductor Soldering and Mounting Techniques Reference Manual, SOLDERRM/D.

**STYLES ON PAGE 2**

<b>DOCUMENT NUMBER:</b>	<b>98ASB42226B</b>	Electronic versions are uncontrolled except when accessed directly from the Document Repository. Printed versions are uncontrolled except when stamped "CONTROLLED COPY" in red.
<b>DESCRIPTION:</b>	<b>SOT-23 (TO-236)</b>	<b>PAGE 1 OF 2</b>

onsemi and ONSEMI are trademarks of Semiconductor Components Industries, LLC dba onsemi or its subsidiaries in the United States and/or other countries. onsemi reserves the right to make changes without further notice to any products herein. onsemi makes no warranty, representation or guarantee regarding the suitability of its products for any particular purpose, nor does onsemi assume any liability arising out of the application or use of any product or circuit, and specifically disclaims any and all liability, including without limitation special, consequential or incidental damages. onsemi does not convey any license under its patent rights nor the rights of others.

**MECHANICAL CASE OUTLINE**  
**PACKAGE DIMENSIONS**



**SOT-23 (TO-236)**  
**CASE 318**  
**ISSUE AT**

DATE 01 MAR 2023

- |   |   |   |   |   |   |
|---|---|---|---|---|---|
| STYLE 1 THRU 5:<br>CANCELLED                            | STYLE 6:<br>PIN 1. BASE<br>2. EMITTER<br>3. COLLECTOR | STYLE 7:<br>PIN 1. EMITTER<br>2. BASE<br>3. COLLECTOR       | STYLE 8:<br>PIN 1. ANODE<br>2. NO CONNECTION<br>3. CATHODE  |   |   |
| STYLE 9:<br>PIN 1. ANODE<br>2. ANODE<br>3. CATHODE      | STYLE 10:<br>PIN 1. DRAIN<br>2. SOURCE<br>3. GATE     | STYLE 11:<br>PIN 1. ANODE<br>2. CATHODE<br>3. CATHODE-ANODE | STYLE 12:<br>PIN 1. CATHODE<br>2. CATHODE<br>3. ANODE       | STYLE 13:<br>PIN 1. SOURCE<br>2. DRAIN<br>3. GATE           | STYLE 14:<br>PIN 1. CATHODE<br>2. GATE<br>3. ANODE          |
| STYLE 15:<br>PIN 1. GATE<br>2. CATHODE<br>3. ANODE      | STYLE 16:<br>PIN 1. ANODE<br>2. CATHODE<br>3. CATHODE | STYLE 17:<br>PIN 1. NO CONNECTION<br>2. ANODE<br>3. CATHODE | STYLE 18:<br>PIN 1. NO CONNECTION<br>2. CATHODE<br>3. ANODE | STYLE 19:<br>PIN 1. CATHODE<br>2. ANODE<br>3. CATHODE-ANODE | STYLE 20:<br>PIN 1. CATHODE<br>2. ANODE<br>3. GATE          |
| STYLE 21:<br>PIN 1. GATE<br>2. SOURCE<br>3. DRAIN       | STYLE 22:<br>PIN 1. RETURN<br>2. OUTPUT<br>3. INPUT   | STYLE 23:<br>PIN 1. ANODE<br>2. ANODE<br>3. CATHODE         | STYLE 24:<br>PIN 1. GATE<br>2. DRAIN<br>3. SOURCE           | STYLE 25:<br>PIN 1. ANODE<br>2. CATHODE<br>3. GATE          | STYLE 26:<br>PIN 1. CATHODE<br>2. ANODE<br>3. NO CONNECTION |
| STYLE 27:<br>PIN 1. CATHODE<br>2. CATHODE<br>3. CATHODE | STYLE 28:<br>PIN 1. ANODE<br>2. ANODE<br>3. ANODE     |   |   |   |   |

<b>DOCUMENT NUMBER:</b>	<b>98ASB42226B</b>	Electronic versions are uncontrolled except when accessed directly from the Document Repository. Printed versions are uncontrolled except when stamped "CONTROLLED COPY" in red.
<b>DESCRIPTION:</b>	<b>SOT-23 (TO-236)</b>	<b>PAGE 2 OF 2</b>

**onsemi** and **ONSEMI** are trademarks of Semiconductor Components Industries, LLC dba **onsemi** or its subsidiaries in the United States and/or other countries. **onsemi** reserves the right to make changes without further notice to any products herein. **onsemi** makes no warranty, representation or guarantee regarding the suitability of its products for any particular purpose, nor does **onsemi** assume any liability arising out of the application or use of any product or circuit, and specifically disclaims any and all liability, including without limitation special, consequential or incidental damages. **onsemi** does not convey any license under its patent rights nor the rights of others.



# MECHANICAL CASE OUTLINE

## PACKAGE DIMENSIONS

ON Semiconductor®



SC-59  
CASE 318D-04  
ISSUE H

DATE 28 JUN 2012

SCALE 2:1

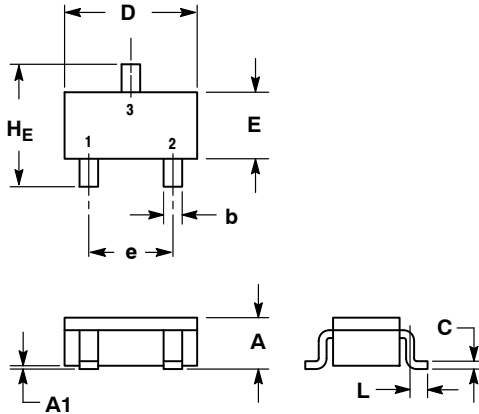

### SOLDERING FOOTPRINT\*

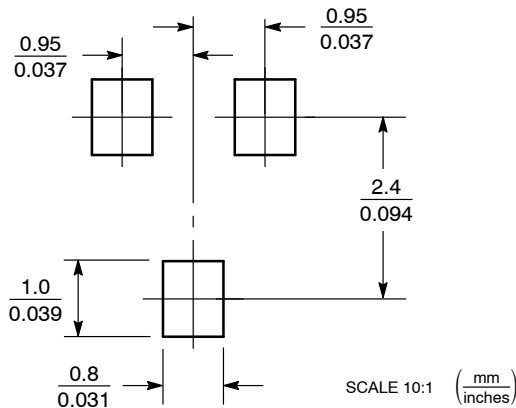

\*For additional information on our Pb-Free strategy and soldering details, please download the ON Semiconductor Soldering and Mounting Techniques Reference Manual, SOLDERRM/D.

NOTES:  
1. DIMENSIONING AND TOLERANCING PER ANSI Y14.5M, 1982.  
2. CONTROLLING DIMENSION: MILLIMETER.

DIM	MILLIMETERS			INCHES		
	MIN	NOM	MAX	MIN	NOM	MAX
A	1.00	1.15	1.30	0.039	0.045	0.051
A1	0.01	0.06	0.10	0.001	0.002	0.004
b	0.35	0.43	0.50	0.014	0.017	0.020
c	0.09	0.14	0.18	0.003	0.005	0.007
D	2.70	2.90	3.10	0.106	0.114	0.122
E	1.30	1.50	1.70	0.051	0.059	0.067
e	1.70	1.90	2.10	0.067	0.075	0.083
L	0.20	0.40	0.60	0.008	0.016	0.024
HE	2.50	2.80	3.00	0.099	0.110	0.118

### GENERIC MARKING DIAGRAM

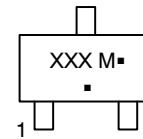

XXX = Specific Device Code  
M = Date Code  
▪ = Pb-Free Package\*

(\*Note: Microdot may be in either location)

\*This information is generic. Please refer to device data sheet for actual part marking. Pb-Free indicator, "G" or microdot "▪", may or may not be present.

STYLE 1:  
PIN 1. BASE  
2. EMITTER  
3. COLLECTOR

STYLE 2:  
PIN 1. ANODE  
2. N.C.  
3. CATHODE

STYLE 3:  
PIN 1. ANODE  
2. ANODE  
3. CATHODE

STYLE 4:  
PIN 1. CATHODE  
2. N.C.  
3. ANODE

STYLE 5:  
PIN 1. CATHODE  
2. CATHODE  
3. ANODE

STYLE 6:  
PIN 1. ANODE  
2. CATHODE  
3. ANODE/CATHODE

DOCUMENT NUMBER:	98ASB42664B	Electronic versions are uncontrolled except when accessed directly from the Document Repository. Printed versions are uncontrolled except when stamped "CONTROLLED COPY" in red.
DESCRIPTION:	SC-59	PAGE 1 OF 1

ON Semiconductor and ON are trademarks of Semiconductor Components Industries, LLC dba ON Semiconductor or its subsidiaries in the United States and/or other countries. ON Semiconductor reserves the right to make changes without further notice to any products herein. ON Semiconductor makes no warranty, representation or guarantee regarding the suitability of its products for any particular purpose, nor does ON Semiconductor assume any liability arising out of the application or use of any product or circuit, and specifically disclaims any and all liability, including without limitation special, consequential or incidental damages. ON Semiconductor does not convey any license under its patent rights nor the rights of others.

# MECHANICAL CASE OUTLINE PACKAGE DIMENSIONS



SCALE 4:1

## SC-70 (SOT-323) CASE 419 ISSUE R

DATE 11 OCT 2022



NOTES:

1. DIMENSIONING AND TOLERANCING PER ASME Y14.5M, 1982.
2. CONTROLLING DIMENSION: INCH

DIM	MILLIMETERS			INCHES		
	MIN.	NOM.	MAX.	MIN.	NOM.	MAX.
A	0.80	0.90	1.00	0.032	0.035	0.040
A1	0.00	0.05	0.10	0.000	0.002	0.004
A2	0.70 REF			0.028 BSC		
b	0.30	0.35	0.40	0.012	0.014	0.016
c	0.10	0.18	0.25	0.004	0.007	0.010
D	1.80	2.00	2.20	0.071	0.080	0.087
E	1.15	1.24	1.35	0.045	0.049	0.053
e	1.20	1.30	1.40	0.047	0.051	0.055
e1	0.65 BSC			0.026 BSC		
L	0.20	0.38	0.56	0.008	0.015	0.022
H <sub>E</sub>	2.00	2.10	2.40	0.079	0.083	0.095

### GENERIC MARKING DIAGRAM



- XX = Specific Device Code
- M = Date Code
- = Pb-Free Package

\*This information is generic. Please refer to device data sheet for actual part marking. Pb-Free indicator, "G" or microdot "■", may or may not be present. Some products may not follow the Generic Marking.

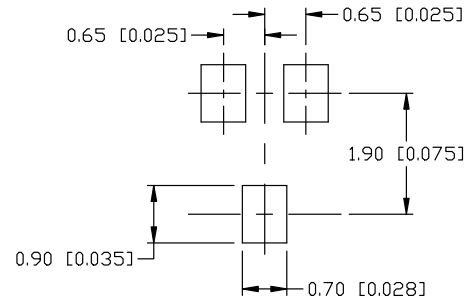

\* For additional information on our Pb-Free strategy and soldering details, please download the DN Semiconductor Soldering and Mounting Techniques Reference Manual, SOLDERM/D.

### SOLDERING FOOTPRINT

- |   |   |   |  |   |   |
|---|---|---|--|---|---|
| STYLE 1:<br>CANCELLED                                 | STYLE 2:<br>PIN 1. ANODE<br>2. N.C.<br>3. CATHODE     | STYLE 3:<br>PIN 1. BASE<br>2. EMITTER<br>3. COLLECTOR | STYLE 4:<br>PIN 1. CATHODE<br>2. CATHODE<br>3. ANODE       | STYLE 5:<br>PIN 1. ANODE<br>2. ANODE<br>3. CATHODE          |   |
| STYLE 6:<br>PIN 1. EMITTER<br>2. BASE<br>3. COLLECTOR | STYLE 7:<br>PIN 1. BASE<br>2. EMITTER<br>3. COLLECTOR | STYLE 8:<br>PIN 1. GATE<br>2. SOURCE<br>3. DRAIN      | STYLE 9:<br>PIN 1. ANODE<br>2. CATHODE<br>3. CATHODE-ANODE | STYLE 10:<br>PIN 1. CATHODE<br>2. ANODE<br>3. ANODE-CATHODE | STYLE 11:<br>PIN 1. CATHODE<br>2. CATHODE<br>3. CATHODE |

<b>DOCUMENT NUMBER:</b>	<b>98ASB42819B</b>	Electronic versions are uncontrolled except when accessed directly from the Document Repository. Printed versions are uncontrolled except when stamped "CONTROLLED COPY" in red.
<b>DESCRIPTION:</b>	<b>SC-70 (SOT-323)</b>	<b>PAGE 1 OF 1</b>

onsemi and ONSEMI are trademarks of Semiconductor Components Industries, LLC dba onsemi or its subsidiaries in the United States and/or other countries. onsemi reserves the right to make changes without further notice to any products herein. onsemi makes no warranty, representation or guarantee regarding the suitability of its products for any particular purpose, nor does onsemi assume any liability arising out of the application or use of any product or circuit, and specifically disclaims any and all liability, including without limitation special, consequential or incidental damages. onsemi does not convey any license under its patent rights nor the rights of others.

# MECHANICAL CASE OUTLINE

## PACKAGE DIMENSIONS

ON Semiconductor®

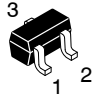

**SC-75/SOT-416**  
CASE 463-01  
ISSUE G

DATE 07 AUG 2015

SCALE 4:1

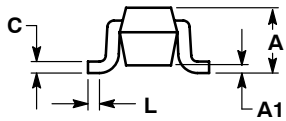
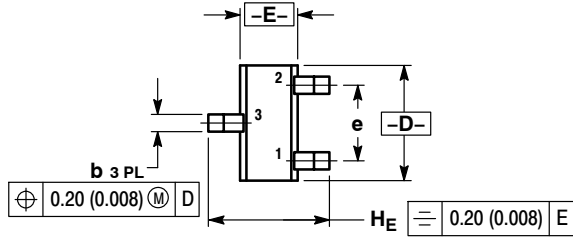

STYLE 1:  
PIN 1. BASE  
2. EMITTER  
3. COLLECTOR

STYLE 2:  
PIN 1. ANODE  
2. N/C  
3. CATHODE

STYLE 3:  
PIN 1. ANODE  
2. ANODE  
3. CATHODE

STYLE 4:  
PIN 1. CATHODE  
2. CATHODE  
3. ANODE

STYLE 5:  
PIN 1. GATE  
2. SOURCE  
3. DRAIN

NOTES:

1. DIMENSIONING AND TOLERANCING PER ANSI Y14.5M, 1982.
2. CONTROLLING DIMENSION: MILLIMETER.

DIM	MILLIMETERS			INCHES		
	MIN	NOM	MAX	MIN	NOM	MAX
A	0.70	0.80	0.90	0.027	0.031	0.035
A1	0.00	0.05	0.10	0.000	0.002	0.004
b	0.15	0.20	0.30	0.006	0.008	0.012
C	0.10	0.15	0.25	0.004	0.006	0.010
D	1.55	1.60	1.65	0.061	0.063	0.065
E	0.70	0.80	0.90	0.027	0.031	0.035
e	1.00 BSC			0.04 BSC		
L	0.10	0.15	0.20	0.004	0.006	0.008
HE	1.50	1.60	1.70	0.060	0.063	0.067

**GENERIC MARKING DIAGRAM\***

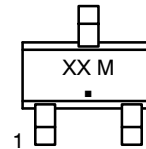

- XX = Specific Device Code
- M = Date Code
- = Pb-Free Package

\*This information is generic. Please refer to device data sheet for actual part marking. Pb-Free indicator, "G" or microdot "■", may or may not be present.

**SOLDERING FOOTPRINT\***

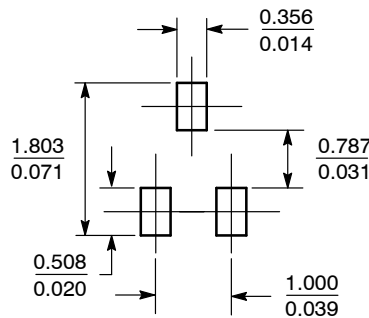

SCALE 10:1 (mm/inches)

\*For additional information on our Pb-Free strategy and soldering details, please download the ON Semiconductor Soldering and Mounting Techniques Reference Manual, SOLDERRM/D.

<b>DOCUMENT NUMBER:</b>	<b>98ASB15184C</b>	Electronic versions are uncontrolled except when accessed directly from the Document Repository. Printed versions are uncontrolled except when stamped "CONTROLLED COPY" in red.
<b>DESCRIPTION:</b>	<b>SC-75/SOT-416</b>	<b>PAGE 1 OF 1</b>

ON Semiconductor and are trademarks of Semiconductor Components Industries, LLC dba ON Semiconductor or its subsidiaries in the United States and/or other countries. ON Semiconductor reserves the right to make changes without further notice to any products herein. ON Semiconductor makes no warranty, representation or guarantee regarding the suitability of its products for any particular purpose, nor does ON Semiconductor assume any liability arising out of the application or use of any product or circuit, and specifically disclaims any and all liability, including without limitation special, consequential or incidental damages. ON Semiconductor does not convey any license under its patent rights nor the rights of others.

# MECHANICAL CASE OUTLINE

## PACKAGE DIMENSIONS

ON Semiconductor®



SCALE 8:1

SOT-1123  
CASE 524AA  
ISSUE C

DATE 29 NOV 2011

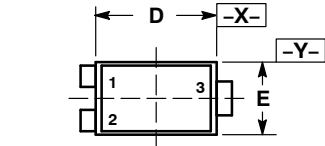

TOP VIEW

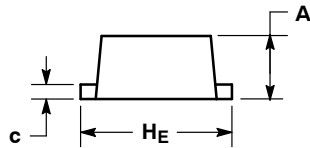

SIDE VIEW

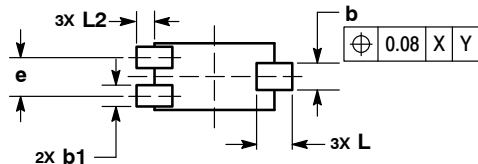

BOTTOM VIEW

### SOLDERING FOOTPRINT\*

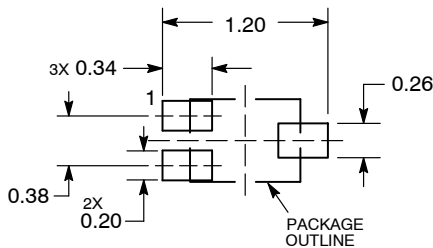

DIMENSIONS: MILLIMETERS

#### NOTES:

1. DIMENSIONING AND TOLERANCING PER ASME Y14.5M, 1994.
2. CONTROLLING DIMENSION: MILLIMETERS.
3. MAXIMUM LEAD THICKNESS INCLUDES LEAD FINISH. MINIMUM LEAD THICKNESS IS THE MINIMUM THICKNESS OF BASE MATERIAL.
4. DIMENSIONS D AND E DO NOT INCLUDE MOLD FLASH, PROTRUSIONS, OR GATE BURRS.

DIM	MILLIMETERS	
	MIN	MAX
A	0.34	0.40
b	0.15	0.28
b1	0.10	0.20
c	0.07	0.17
D	0.75	0.85
E	0.55	0.65
e	0.35	0.40
HE	0.95	1.05
L	0.185	REF
L2	0.05	0.15

### GENERIC MARKING DIAGRAM\*

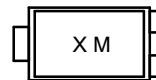

X = Specific Device Code  
M = Date Code

\*This information is generic. Please refer to device data sheet for actual part marking.  
Pb-Free indicator, "G" or microdot "•", may or may not be present.

\*For additional information on our Pb-Free strategy and soldering details, please download the ON Semiconductor Soldering and Mounting Techniques Reference Manual, SOLDERRM/D.

#### STYLE 1:

PIN 1. BASE  
2. EMITTER  
3. COLLECTOR

#### STYLE 2:

PIN 1. ANODE  
2. N/C  
3. CATHODE

#### STYLE 3:

PIN 1. ANODE  
2. ANODE  
3. CATHODE

#### STYLE 4:

PIN 1. CATHODE  
2. CATHODE  
3. ANODE

#### STYLE 5:

PIN 1. GATE  
2. SOURCE  
3. DRAIN

<b>DOCUMENT NUMBER:</b>	<b>98AON23134D</b>	Electronic versions are uncontrolled except when accessed directly from the Document Repository. Printed versions are uncontrolled except when stamped "CONTROLLED COPY" in red.
<b>DESCRIPTION:</b>	<b>SOT-1123, 3-LEAD, 1.0X0.6X0.37, 0.35P</b>	<b>PAGE 1 OF 1</b>

ON Semiconductor and are trademarks of Semiconductor Components Industries, LLC dba ON Semiconductor or its subsidiaries in the United States and/or other countries. ON Semiconductor reserves the right to make changes without further notice to any products herein. ON Semiconductor makes no warranty, representation or guarantee regarding the suitability of its products for any particular purpose, nor does ON Semiconductor assume any liability arising out of the application or use of any product or circuit, and specifically disclaims any and all liability, including without limitation special, consequential or incidental damages. ON Semiconductor does not convey any license under its patent rights nor the rights of others.

# MECHANICAL CASE OUTLINE

## PACKAGE DIMENSIONS

ON Semiconductor®



SCALE 4:1

**SOT-723**  
CASE 631AA-01  
ISSUE D

DATE 10 AUG 2009

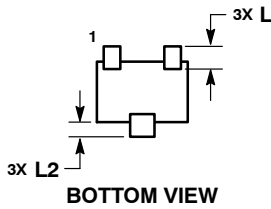
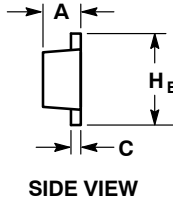

**NOTES:**

1. DIMENSIONING AND TOLERANCING PER ASME Y14.5M, 1994.
2. CONTROLLING DIMENSION: MILLIMETERS.
3. MAXIMUM LEAD THICKNESS INCLUDES LEAD FINISH. MINIMUM LEAD THICKNESS IS THE MINIMUM THICKNESS OF BASE MATERIAL.
4. DIMENSIONS D AND E DO NOT INCLUDE MOLD FLASH, PROTRUSIONS OR GATE BURRS.

MILLIMETERS			
DIM	MIN	NOM	MAX
A	0.45	0.50	0.55
b	0.15	0.21	0.27
b1	0.25	0.31	0.37
C	0.07	0.12	0.17
D	1.15	1.20	1.25
E	0.75	0.80	0.85
e	0.40 BSC		
H E	1.15	1.20	1.25
L	0.29 REF		
L2	0.15	0.20	0.25

**GENERIC MARKING DIAGRAM\***

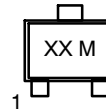

XX = Specific Device Code  
M = Date Code

- |   |  |  |  |  |
|---|--|--|--|--|
| STYLE 1:<br>PIN 1. BASE<br>2. EMITTER<br>3. COLLECTOR | STYLE 2:<br>PIN 1. ANODE<br>2. N/C<br>3. CATHODE | STYLE 3:<br>PIN 1. ANODE<br>2. ANODE<br>3. CATHODE | STYLE 4:<br>PIN 1. CATHODE<br>2. CATHODE<br>3. ANODE | STYLE 5:<br>PIN 1. GATE<br>2. SOURCE<br>3. DRAIN |
|---|--|--|--|--|

**RECOMMENDED SOLDERING FOOTPRINT\***

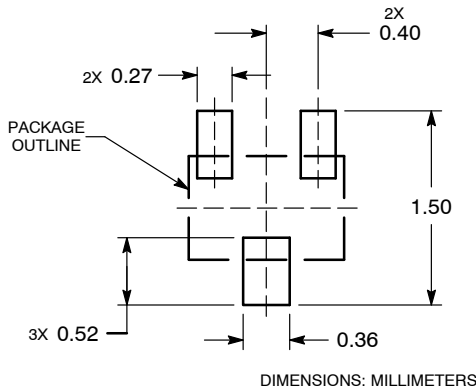

\*This information is generic. Please refer to device data sheet for actual part marking. Pb-Free indicator, "G", may or not be present.

\*For additional information on our Pb-Free strategy and soldering details, please download the ON Semiconductor Soldering and Mounting Techniques Reference Manual, SOLDERRM/D.

<b>DOCUMENT NUMBER:</b>	<b>98AON12989D</b>	Electronic versions are uncontrolled except when accessed directly from the Document Repository. Printed versions are uncontrolled except when stamped "CONTROLLED COPY" in red.
<b>DESCRIPTION:</b>	<b>SOT-723</b>	<b>PAGE 1 OF 1</b>

ON Semiconductor and are trademarks of Semiconductor Components Industries, LLC dba ON Semiconductor or its subsidiaries in the United States and/or other countries. ON Semiconductor reserves the right to make changes without further notice to any products herein. ON Semiconductor makes no warranty, representation or guarantee regarding the suitability of its products for any particular purpose, nor does ON Semiconductor assume any liability arising out of the application or use of any product or circuit, and specifically disclaims any and all liability, including without limitation special, consequential or incidental damages. ON Semiconductor does not convey any license under its patent rights nor the rights of others.