

## Wireless 500 Amp AC Current Meters

### General Description

The ALTA wireless AC Current Meter measures the RMS current of an alternating current (AC) system using a current transformer (CT) that wraps around the “hot” wire of a two wire (hot, common, ground(optional)) power system. The sensor reports Minimum RMS current, maximum RMS current, average RMS current, and amp hours to the iMonnit system. The iMonnit system is capable of generating watt hour or kilowatt hour readings as well.

- Measures amp hours, max RMS current, min RMS current, and average RMS current
- Three different current transducers available:
  - Low Current: 0-20 amp
  - Medium Current: 0-150 amp
  - High Current: 0-500 amp
- Capable of generating watt hour or kilowatt hour readings using iMonnit
- Data logging for accumulated amp hour readings
- Can notify based on current levels or changes in current levels
- Simple and safe installation of current/power measurement hardware, no rewiring required

### Principle of Operation

To measure current, clip the CT around only a single wire of the AC system (clipping around a hot and neutral wire at the same time will result in 0 current readings). After the sensor powers on and connects to the gateway it will begin taking measurements based on the averaging interval (5 seconds default). It will report data to iMonnit every heartbeat or if the current goes outside of the aware thresholds set in iMonnit. The sensor reports amp hours, max RMS current, min RMS current, and average RMS current. iMonnit can also generate watt hour or kilowatt hour readings if a default RMS voltage is set in iMonnit.

### Example Interfacing

- Current monitoring
- Current usage
- Amperage monitoring
- Amp hour meter

### Features of Monnit ALTA Sensors

- Wireless range of 1,200+ feet through 12+ walls \*
- Frequency-Hopping Spread Spectrum (FHSS)
- Improved interference immunity
- Improved power management for longer battery life \*\* (12+ years on AA batteries)
- Encrypt-RF<sup>®</sup> Security (Diffie-Hellman Key Exchange + AES-128 CBC for sensor data messages)
- All ALTA sensors now have up to 3200 readings:
  - 10-minute heartbeats = 22 days
  - 2-hour heartbeats = 266 days
- Over-the-air updates (future proof)
- Free iMonnit basic online wireless sensor monitoring and notification system to configure sensors, view data and set alerts via SMS text and email

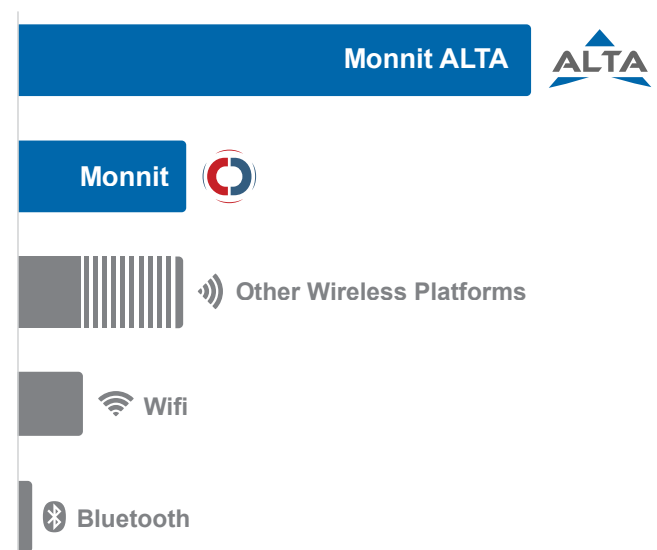

- \* Actual range may vary depending on environment.
- \*\* Battery life is determined by sensor reporting frequency and other variables. Other power options are also available.

### Wireless Range Comparison

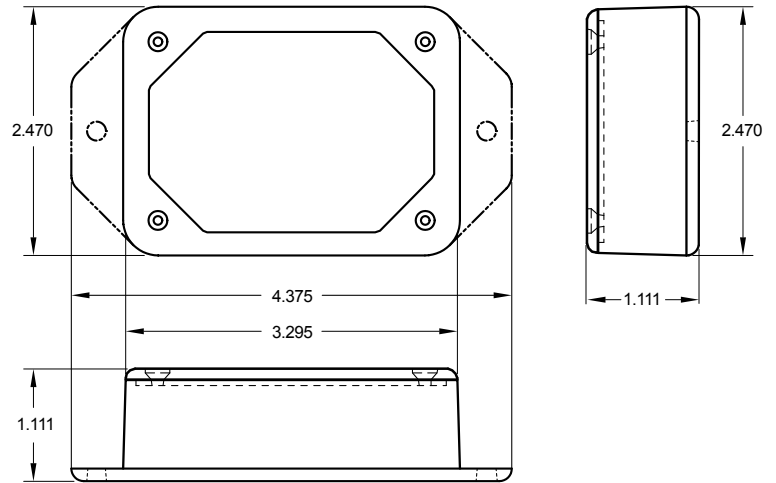



## ALTA Commercial AA Wireless AC Current Meter | Technical Specifications

Supply voltage	2.0–3.8 VDC (3.0–3.8 VDC using power supply) *
Current consumption	0.2 $\mu$ A (sleep mode), 0.7 $\mu$ A (RTC sleep), 570 $\mu$ A (MCU idle), 2.5 mA (MCU active), 5.5 mA (radio RX mode), 22.6 mA (radio TX mode)
Operating temperature range (board circuitry and batteries)	-18°C to 55°C (0°F to 130°F) using alkaline -40°C to 85°C (-40°F to 185°F) using lithium **
Optimal battery temperature range (AA)	+10°C to +50°C (+50°F to +122°F)
Integrated memory	Up to 3200 sensor messages
Wireless range	1,200+ ft non-line-of-sight
Security	Encrypt-RF® (256-bit key exchange and AES-128 CTR)
Weight	3.7 ounces (Without CT)
Certifications	<div style="display: flex; align-items: center; gap: 10px;">   <span>Industry Canada</span> </div> 900 MHz product; FCC ID: ZTL-G2SC1 and IC: 9794A-G2SC1. 868 and 433 MHz product tested and found to comply with: EN 300 220-2 V3.1.1 (2017-02), EN 300 220-2 V3.1.1 (2017-02) and EN 60950

\* Circuits cannot withstand negative voltage. Please take care when installing batteries.

\*\* At temperatures above 100°C, it is possible for the board circuitry to lose programmed memory.

## Power Options



The standard version of this sensor is powered by two replaceable 1.5 V AA sized batteries (included with purchase).

This sensor is also available with a line power option. The line powered version of this sensor has a barrel power connector allowing it to be powered by a standard 3.0–3.6 V power supply. The line powered version also uses two standard 1.5 V AA batteries as backup for uninterrupted operation in the event of line power outage.

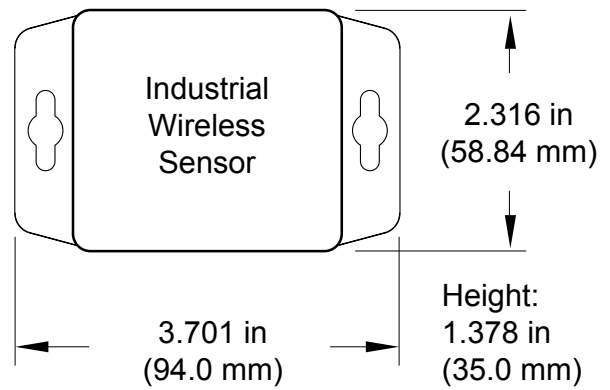
Power options must be selected at time of purchase, as the internal hardware of the sensor must be changed to support the selected power requirements.



### ALTA Industrial Wireless AC Current Meter | Technical Specifications

Supply voltage	2.0–3.8 VDC (3.0–3.8 VDC using power supply) *	
Current consumption	0.2 $\mu$ A (sleep mode), 0.7 $\mu$ A (RTC sleep), 570 $\mu$ A (MCU idle), 2.5 mA (MCU active), 5.5 mA (radio RX mode), 22.6 mA (radio TX mode)	
Operating temperature range (board circuitry and battery)	-40°C to +85°C (-40°F to +185°F) **	
Included battery	Max temperature range	-40° to +85°C (-40° to +185°F)
	Capacity	1500 mAh
Optional solar feature	Solar panel	5VDC/30mA (53mm x 30mm)
	Charging temperature range	0° to 45°C (32° to 113°F)
	Max temperature range	-20° to 60°C (-4° to 140°F)
	Included rechargeable battery	600 mAh/>2000 charge cycles (80% of initial capacity)
	Solar efficiency	Optimized for high and low-light operation ***
Integrated memory	Up to 3200 sensor messages	
Wireless range	1,200+ ft non-line-of-sight	
Security	Encrypt-RF® (256-bit key exchange and AES-128 CTR)	
Weight	4.7 ounces (Without CT)	
Enclosure rating	NEMA 1, 2, 4, 4x, 12 and 13 rated, sealed and weather proof	
UL rating	UL Listed to UL508-4x specifications (File E194432)	
Certifications	 	900 MHz product; FCC ID: ZTL-G2SC1 and IC: 9794A-G2SC1. 868 and 433 MHz product tested and found to comply with: EN 300 220-2 V3.1.1 (2017-02), EN 300 220-2 V3.1.1 (2017-02) and EN 60950

\* Circuits cannot withstand negative voltage. Please take care when installing batteries.

\*\* At temperatures above 100°C, it is possible for the board circuitry to lose programmed memory.

\*\*\* Light present 25% of day yields 125% of operating power to support 10-minute heartbeats.

### 0-20 Amp CT Specifications

Absolute max CT current	50 Amps RMS (A rms)
Maximum accurate CT current	20 A rms
Frequency range	50–100 Hz
Accuracy	+/- (2% +.07 A rms)**
Calibrated accuracy with appropriate offset	+/- (1% + .035 A rms)**
Offset limits	-1.27 to + 1.27 A rms (default set to +0.1 A rms) ***
Measurement resolution	~.01 A rms
Typical Deadband	~0.1 A rms ***
Current transducer dimensions	40 mm x 25 mm x 26 mm (10 mm inner diameter)
Weight	2.10 ounces (CT only)
Lead Length	3 feet

### 0-150 Amp CT Specifications

Absolute max CT current	200 Amps RMS (A rms)
Maximum accurate CT current	150 A rms
Frequency range	50–100 Hz
Accuracy	+/- (2% + .4 A rms)**
Calibrated accuracy with appropriate offset	+/- (1% + .2 A rms) **
Offset limits	-1.27 to + 1.27 A rms (default set to + 0.3 A rms) ***
Measurement resolution	~0.1 A rms
Typical Deadband	~0.3 A rms***
Current transducer dimensions	67 mm x 49 mm x 42 mm (24 mm inner diameter)
Weight	7.27 ounces (CT only)
Lead Length	3 feet

### 0-500 Amp CT Specifications

Absolute max CT current	600 Amps RMS (A rms)
Maximum accurate CT current	500 A rms
Frequency range	50–100 Hz
Accuracy	+/- (2% + 1.4 A rms) **
Calibrated accuracy with appropriate offset	+/- (1% + .7 A rms) **
Offset Compensation Limits	-327.68 to + 327.68 A rms (default set to + 1.45 A rms) ***
Measurement resolution	~0.3A rms
Typical Deadband	~1.45 A rms ***
Current transducer dimensions	93 mm x 68 mm x 52 mm (36 mm inner diameter)
Weight	14.55 ounces (CT only)
Lead Length	3 feet

\* Circuits cannot withstand negative voltage. Please take care when installing batteries.

\*\* CTs are inherently less accurate at or below 10% of max range. For best calibration results calibrate at a current between 30% and 90% of max accurate range.

\*\*\* Because of a diode inherent to the hardware, the sensor is incapable of reading between 0 and the deadband value. This diode also creates an offset. To account for this, the firmware uses offset compensation