

## Wireless Humidity Sensors

### General Description

The ALTA Wireless Humidity (RH) Sensor allows you to accurately monitor the relative humidity of the air within a room or enclosure.

- Measures relative humidity, temperature and dew point with high accuracy

### Principle of Operation

The ALTA Wireless Humidity (RH) Sensor measures the relative humidity at the device. The sensor returns RH and temperature values to the iMonnit Online Sensor Monitoring and Notification System. The system calculates dew point from the data and stores all three data points in the online system where the data can be reviewed and exported as a data sheet or graph. Notifications can be set up through the online system to alert the user when defined thresholds have been met or exceeded.

### Example Interfacing

- Greenhouse humidity monitoring
- Agriculture environmental monitoring
- Art gallery and museum environmental monitoring
- Humidor monitoring
- General weather and environmental monitoring
- Many additional applications

### Features of Monnit ALTA Sensors

- Wireless range of 1,200+ feet through 12+ walls \*
- Frequency-Hopping Spread Spectrum (FHSS)
- Improved interference immunity
- Improved power management for longer battery life \*\* (12+ years on AA batteries)
- Encrypt-RF® Security (Diffie-Hellman Key Exchange + AES-128 CBC for sensor data messages)
- Datalogs 2000 to 4000 readings if gateway connection is lost (non-volatile flash, persists through the power cycle):

- 10-minute heartbeats = ~ 22 days
- 2-hour heartbeats = ~ 266 days

- Over-the-air updates (future proof)
- Free iMonnit basic online wireless sensor monitoring and notification system to configure sensors, view data and set alerts via SMS text and email

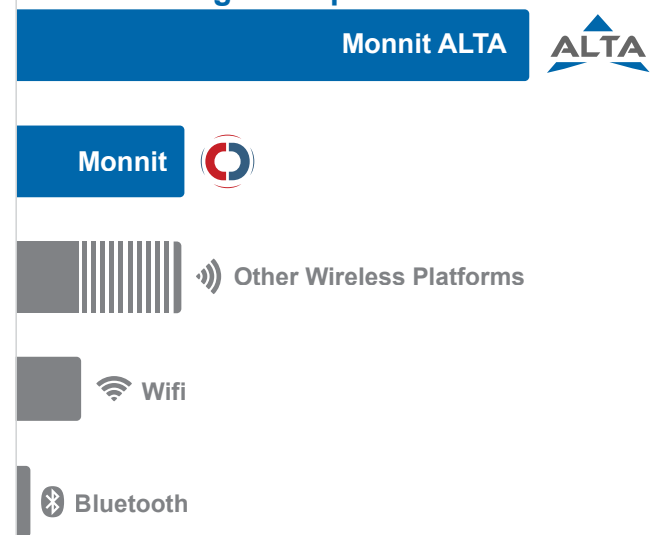

\* Actual range may vary depending on environment.  
 \*\* Battery life is determined by sensor reporting frequency and other variables. Other power options are also available.

### Wireless Range Comparison

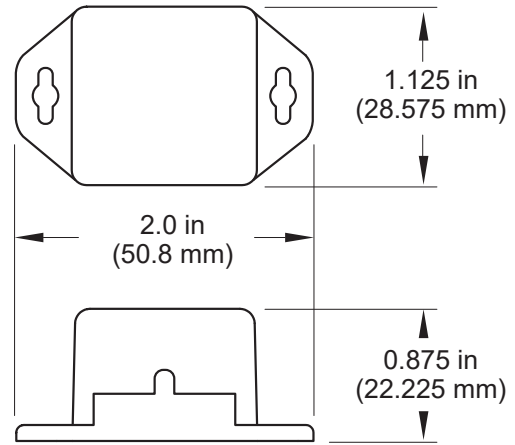



## ALTA Commercial Coin Cell Wireless Humidity Sensor | Technical Specifications

Supply voltage	2.0–3.8 VDC *
Current consumption	0.2 $\mu$ A (sleep mode), 0.7 $\mu$ A (RTC sleep), 570 $\mu$ A (MCU idle), 2.5 mA (MCU active), 5.5 mA (radio RX mode), 22.6 mA (radio TX mode)
Operating temperature range (board circuitry and coin cell)	-7°C to +55°C (20°F to +131°F)
Optimal battery temperature range (coin cell)	+10°C to +50°C (+50°F to +122°F)
Accuracy	$\pm$ 2% under normal conditions (0%–80% RH) **
RH operating range	0–100% RH **
RH response time	8 sec (tau 63%) **
Datalogging	Datalogs 2000 to 4000 readings if gateway connection is lost (non-volatile flash, persists through the power cycle): - 10-minute heartbeats = ~ 22 days - 2-hour heartbeats = ~ 266 days
Wireless range	1,200+ ft non-line-of-sight
Security	Encrypt-RF® (256-bit key exchange and AES-128 CTR)
Weight	0.7 ounces
Certifications	  900 MHz product; FCC ID: ZTL-G2SC1 and IC: 9794A-G2SC1. 868 and 433 MHz product tested and found to comply with: EN 300 220-2 V3.1.1 (2017-02), EN 300 220-2 V3.1.1 (2017-02) and EN 60950

\* Hardware cannot withstand negative voltage. Please take care when connecting a power device.

\*\* View charts on last page for more information.

## PinchPower™ Enclosures

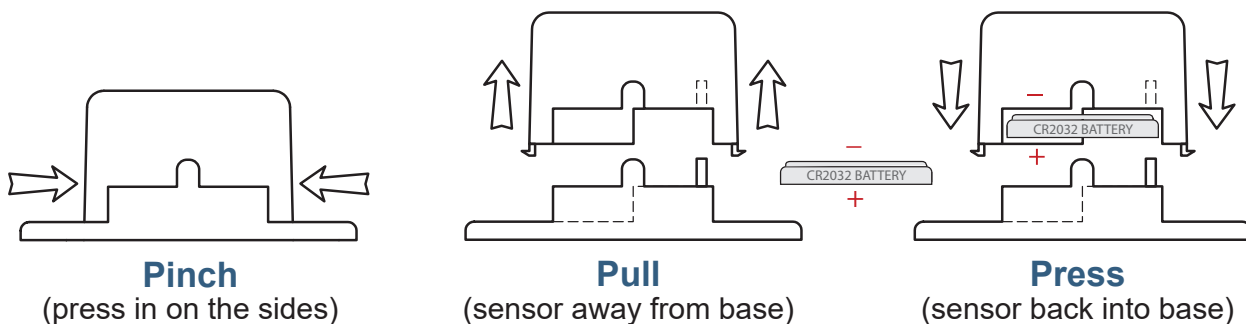



## ALTA Commercial AA Wireless Humidity Sensor | Technical Specifications

Supply voltage	2.0–3.8 VDC (3.0–3.8 VDC using power supply) *
Current consumption	0.2 $\mu$ A (sleep mode), 0.7 $\mu$ A (RTC sleep), 570 $\mu$ A (MCU idle), 2.5 mA (MCU active), 5.5 mA (radio RX mode), 22.6 mA (radio TX mode)
Operating temperature range (board circuitry and batteries)	-18°C to 50°C (0°F to 122°F) using alkaline -40°C to 80°C (-40°F to 176°F) using lithium
Optimal battery temperature range (AA)	+10°C to +45°C (+50°F to +113°F)
Accuracy	$\pm$ 2% under normal conditions (0%–80% RH) **
RH operating range	0–100% RH **
RH response time	8 sec (tau 63%) **
Datalogging	Datalogs 2000 to 4000 readings if gateway connection is lost (non-volatile flash, persists through the power cycle): - 10-minute heartbeats = ~ 22 days - 2-hour heartbeats = ~ 266 days
Wireless range	1,200+ ft non-line-of-sight
Security	Encrypt-RF® (256-bit key exchange and AES-128 CTR)
Weight	3.7 ounces
Certifications	900 MHz product; FCC ID: ZTL-G2SC1 and IC: 9794A-G2SC1. 868 and 433 MHz product tested and found to comply with: EN 300 220-2 V3.1.1 (2017-02), EN 300 220-2 V3.1.1 (2017-02) and EN 60950



\* Hardware cannot withstand negative voltage. Please take care when connecting a power device.

\*\* View charts on last page for more information.

## Power Options



The standard version of this sensor is powered by two replaceable 1.5 V AA sized batteries (included with purchase).

This sensor is also available with a line power option. The line powered version of this sensor has a barrel power connector allowing it to be powered by a standard 3.0–3.6 V power supply. The line powered version also uses two standard 1.5 V AA batteries as backup for uninterrupted operation in the event of line power outage.

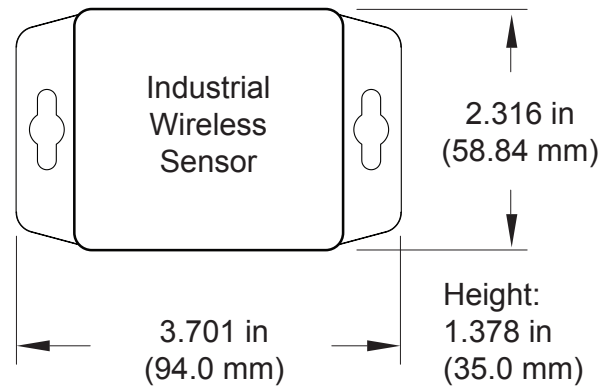
Power options must be selected at time of purchase, as the internal hardware of the sensor must be changed to support the selected power requirements.



### ALTA Industrial Wireless Humidity Sensor | Technical Specifications

Supply voltage	2.0–3.8 VDC (3.0–3.8 VDC using power supply) *	
Current consumption	0.2 $\mu$ A (sleep mode), 0.7 $\mu$ A (RTC sleep), 570 $\mu$ A (MCU idle), 2.5 mA (MCU active), 5.5 mA (radio RX mode), 22.6 mA (radio TX mode)	
Operating temperature range (board circuitry and battery)	-40°C to +80°C (-40°F to +176°F)	
Included battery	Max temperature range	-40° to +80°C (-40° to +176°F)
	Capacity	1500 mAh
Optional solar feature	Solar panel	5VDC/30mA (53mm x 30mm)
	Charging temperature range	0° to 45°C (32° to 113°F)
	Max temperature range	-20° to 60°C (-4° to 140°F)
	Included rechargeable battery	600 mAh/>2000 charge cycles (80% of initial capacity)
	Solar efficiency	Optimized for high and low-light operation **
	Charging efficiency	40% ****
Luminous sustainability	Minimum of 250 LUX ****	
Accuracy	$\pm$ 2% under normal conditions (0%–80% RH) ***	
RH operating range	0–100% RH ***	
RH response time	8 sec (tau 63%) ***	
Datalogging	Datalogs 2000 to 4000 readings if gateway connection is lost (non-volatile flash, persists through the power cycle): - 10-minute heartbeats = ~ 22 days - 2-hour heartbeats = ~ 266 days	
Wireless range	1,200+ ft non-line-of-sight	
Security	Encrypt-RF® (256-bit key exchange and AES-128 CTR)	
Weight	4.7 ounces	
Enclosure rating	NEMA 1, 2, 4, 4x, 12 and 13 rated, sealed and weather proof	
UL rating	UL Listed to UL508-4x specifications (File E194432)	
Certifications	 	900 MHz product; FCC ID: ZTL-G2SC1 and IC: 9794A-G2SC1. 868 and 433 MHz product tested and found to comply with: EN 300 220-2 V3.1.1 (2017-02), EN 300 220-2 V3.1.1 (2017-02) and EN 60950

\* Hardware cannot withstand negative voltage. Please take care when connecting a power device.

\*\* Light present 25% of day yields 125% of operating power to support 10-minute heartbeats.

\*\*\* View charts on last page for more information.

\*\*\*\* Solar feature's energy harvesting circuitry works indoors with low light.