

6-Pin DIP Zero-Cross Triac Driver Optocoupler (600 Volt Peak)



ON Semiconductor®

www.onsemi.com

MOC3061M, MOC3062M, MOC3063M, MOC3162M, MOC3163M

Description

The MOC306XM and MOC316XM devices consist of a GaAs infrared emitting diode optically coupled to a monolithic silicon detector performing the function of a zero voltage crossing bilateral triac driver.

They are designed for use with a triac in the interface of logic systems to equipment powered from 115/240 VAC lines, such as solid-state relays, industrial controls, motors, solenoids and consumer appliances, etc.

Features

- Simplifies Logic Control of 115/240 VAC Power
- Zero Voltage Crossing to Minimize Conducted and Radiated Line Noise
- 600 V Peak Blocking Voltage
- Superior Static dv/dt
 - ◆ 600 V/μs (MOC306xM)
 - ◆ 1000 V/μs (MOC316xM)
- Safety and Regulatory Approvals
 - ◆ UL1577, 4,170 VAC_{RMS} for 1 Minute
 - ◆ DIN EN/IEC60747-5-5
- These are Pb-Free Devices

Applications

- Solenoid/Valve Controls
- Static Power Switches
- Temperature Controls
- AC Motor Starters
- Lighting Controls
- AC Motor Drives
- E.M. Contactors
- Solid State Relays

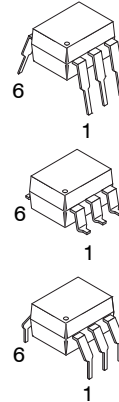

PDIP6 8.51x6.35, 2.54P
CASE 646BX

PDIP6 8.51x6.35, 2.54P
CASE 646BY

PDIP6 8.51x6.35, 2.54P
CASE 646BZ

MARKING DIAGRAM

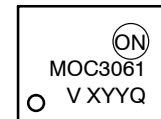

- MOC3061 = Device Number
 V = DIN EN/IEC60747-5-5 Option (only appears on component ordered with this option)
 X = One-Digit Year Code, e.g., '5'
 YY = Two-Digit Work Week, Ranging from '01' to '53'
 Q = Assembly Package Code

SCHEMATIC

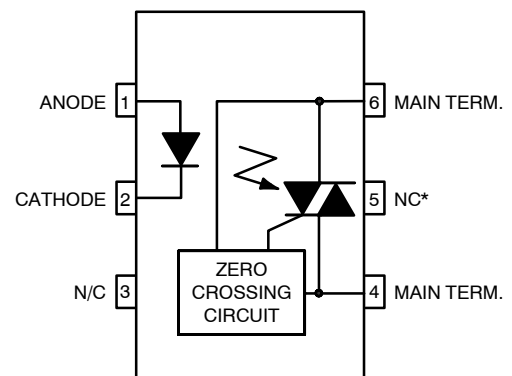

*DO NOT CONNECT (TRIAC SUBSTRATE)

ORDERING INFORMATION

See detailed ordering and shipping information on page 8 of this data sheet.

MOC3061M, MOC3062M, MOC3063M, MOC3162M, MOC3163M

SAFETY AND INSULATION RATINGS (As per DIN EN/IEC 60747-5-5, this optocoupler is suitable for “safe electrical insulation” only within the safety limit data. Compliance with the safety ratings shall be ensured by means of protective circuits.)

Parameter		Characteristics
Installation Classifications per DIN VDE 0110/1.89 Table 1, For Rated Mains Voltage	<150 V _{RMS}	I-IV
	<300 V _{RMS}	I-IV
Climatic Classification		40/85/21
Pollution Degree (DIN VDE 0110/1.89)		2
Comparative Tracking Index		175

Symbol	Parameter	Value	Unit
V _{PR}	Input-to-Output Test Voltage, Method A, V _{IORM} × 1.6 = V _{PR} , Type and Sample Test with t _m = 10 s, Partial Discharge < 5 pC	1360	V _{peak}
	Input-to-Output Test Voltage, Method B, V _{IORM} × 1.875 = V _{PR} , 100% Production Test with t _m = 1 s, Partial Discharge < 5 pC	1594	V _{peak}
V _{IORM}	Maximum Working Insulation Voltage	850	V _{peak}
V _{IOTM}	Highest Allowable Over-Voltage	6000	V _{peak}
	External Creepage	≥7	mm
	External Clearance	≥7	mm
	External Clearance (for Option TV, 0.4” Lead Spacing)	≥10	mm
DTI	Distance Through Insulation (Insulation Thickness)	≥0.5	mm
R _{IO}	Insulation Resistance at T _S , V _{IO} = 500 V	>10 ⁹	Ω

ABSOLUTE MAXIMUM RATINGS (T_A = 25°C unless otherwise noted)

Symbol	Parameter	Device	Value	Unit
--------	-----------	--------	-------	------

TOTAL DEVICE

T _{STG}	Storage Temperature	All	-40 to +150	°C
T _{OPR}	Operating Temperature	All	-40 to +85	°C
T _J	Junction Temperature Range	All	-40 to +100	°C
T _{SOL}	Lead Solder Temperature	All	260 for 10 seconds	°C
P _D	Total Device Power Dissipation at 25°C Ambient	All	250	mW
	Derate Above 25°C		2.94	mW/°C

EMITTER

I _F	Continuous Forward Current	All	60	mA
V _R	Reverse Voltage	All	6	V
P _D	Total Power Dissipation at 25°C Ambient	All	120	mW
	Derate Above 25°C		1.41	mW/°C

DETECTOR

V _{DRM}	Off-State Output Terminal Voltage	All	600	V
I _{TSM}	Peak Non-Repetitive Surge Current (Single Cycle 60 Hz Sine Wave)	All	1	A _{peak}
I _{TM}	Peak Repetitive On-State Current	All	100	mA _{peak}
P _D	Total Power Dissipation at 25°C Ambient	All	150	mW
	Derate Above 25°C		1.76	mW/°C

Stresses exceeding those listed in the Maximum Ratings table may damage the device. If any of these limits are exceeded, device functionality should not be assumed, damage may occur and reliability may be affected.

MOC3061M, MOC3062M, MOC3063M, MOC3162M, MOC3163M

ELECTRICAL CHARACTERISTICS (T_A = 25°C, unless otherwise noted)

Symbol	Parameter	Test Conditions	Device	Min	Typ	Max	Unit
--------	-----------	-----------------	--------	-----	-----	-----	------

INDIVIDUAL COMPONENT CHARACTERISTICS

EMITTER							
V _F	Input Forward Voltage	I _F = 30 mA	All	–	1.3	1.5	V
I _R	Reverse Leakage Current	V _R = 6 V	All	–	0.005	100	μA
DETECTOR							
I _{DRM1}	Peak Blocking Current, Either Direction	V _{DRM} = 600 V, I _F = 0 (Note 1)	MOC306XM	–	10	500	nA
			MOC316XM	–	10	100	
dv/dt	Critical Rate of Rise of Off-State Voltage	I _F = 0 (Note 2)	MOC306XM	600	1500	–	V/μs
			MOC316XM	1000	–	–	

TRANSFER CHARACTERISTICS

I _{FT}	LED Trigger Current (Rated I _{FT})	Main Terminal Voltage = 3 V (Note 3)	MOC3061M	–	–	15	mA
			MOC3062M MOC3162M	–	–	10	
			MOC3063M MOC3163M	–	–	5	
V _{TM}	Peak On-State Voltage, Either Direction	I _{TM} = 100 mA peak, I _F = rated I _{FT}	All	–	1.8	3.0	V
I _H	Holding Current, Either Direction		All	–	500	–	μA

ZERO CROSSING CHARACTERISTICS

V _{INH}	Inhibit Voltage (MT1–MT2 Voltage Above Which Device will not Trigger)	I _F = rated I _{FT}	MOC3061M MOC3062M MOC3063M	–	12	20	V
			MOC3162M MOC3163M	–	12	15	V
I _{DRM2}	Leakage in Inhibited State	I _F = rated I _{FT} , V _{DRM} = 600 V, off-state	All	–	–	2	mA

ISOLATION CHARACTERISTICS

V _{ISO}	Isolation Voltage (Note 4)	f = 60 Hz, t = 1 Minute		4170	–	–	VAC _{RMS}
R _{ISO}	Isolation Resistance	V _{I-O} = 500 V _{DC}		–	1011	–	Ω
C _{ISO}	Isolation Capacitance	V = 0 V, f = 1 MHz		–	0.2	–	pF

Product parametric performance is indicated in the Electrical Characteristics for the listed test conditions, unless otherwise noted. Product performance may not be indicated by the Electrical Characteristics if operated under different conditions.

- Test voltage must be applied within dv/dt rating.
- This is static dv/dt. Commutating dv/dt is a function of the load-driving thyristor(s) only.
- All devices are guaranteed to trigger at an I_F value less than or equal to max I_{FT}. Therefore, recommended operating I_F lies between max I_{FT} (15 mA for MOC3061M, 10 mA for MOC3062M and MOC3162M, 5 mA for MOC3063M and MOC3163M) and absolute maximum I_F (60 mA).
- Isolation voltage, V_{ISO}, is an internal device dielectric breakdown rating. For this test, pins 1 and 2 are common, and pins 4, 5 and 6 are common.

TYPICAL PERFORMANCE CURVES

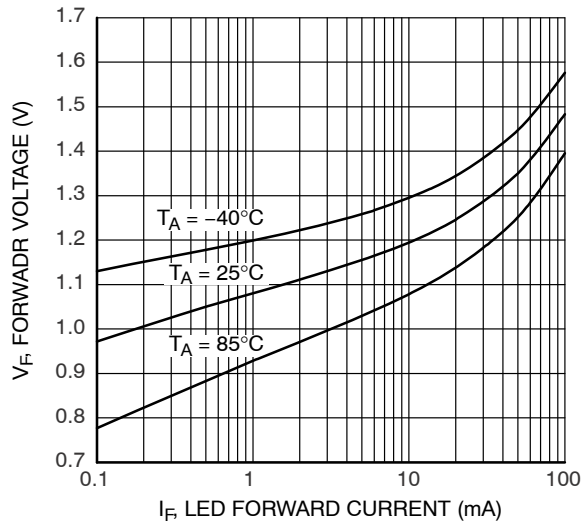

Figure 1. LED Forward Voltage vs. Forward Current

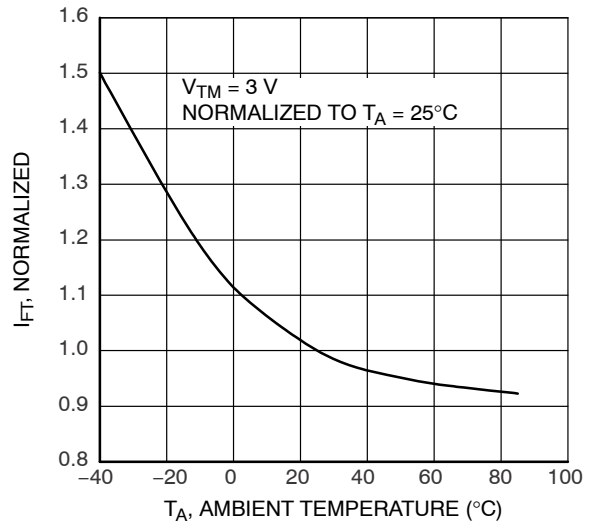

Figure 2. Trigger Current Vs. Temperature

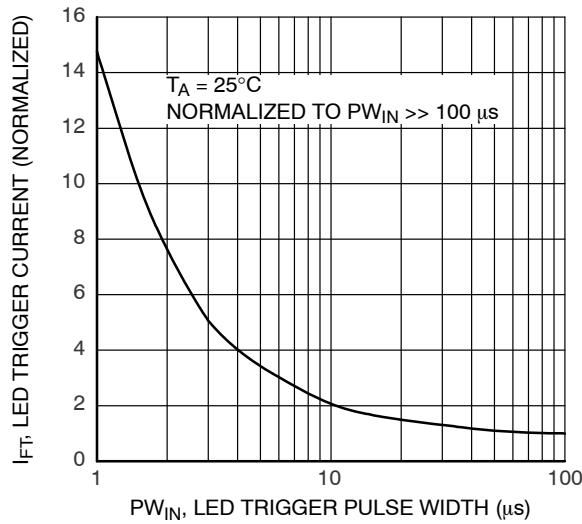

Figure 3. LED Current Required to Trigger vs. LED Pulse Width

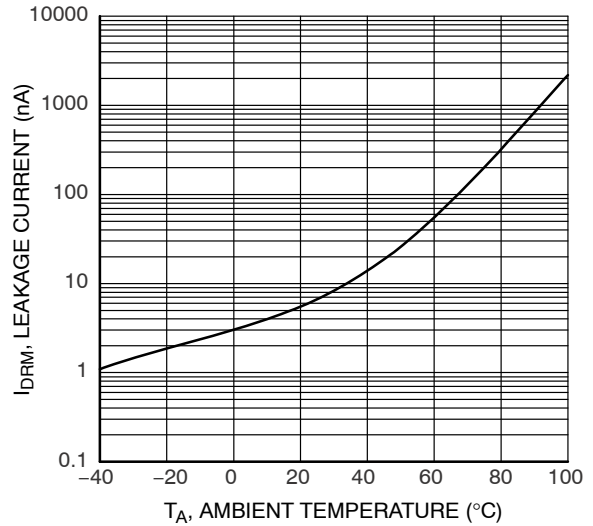

Figure 4. Leakage Current, I_{DRM} vs. Temperature

TYPICAL PERFORMANCE CURVES (Continued)

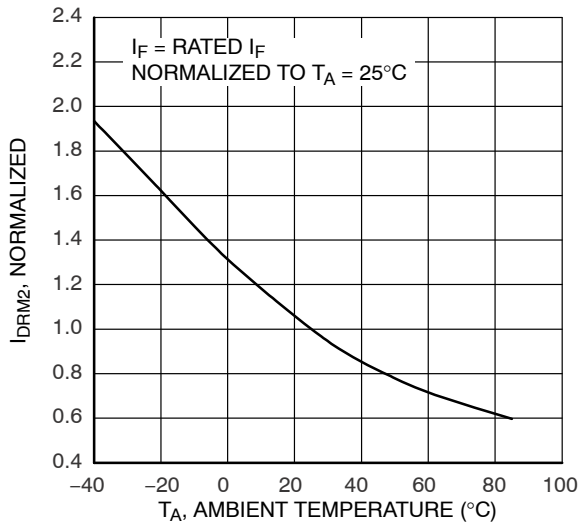

Figure 5. I_{DRM2} , Leakage in Inhibit State vs. Temperature

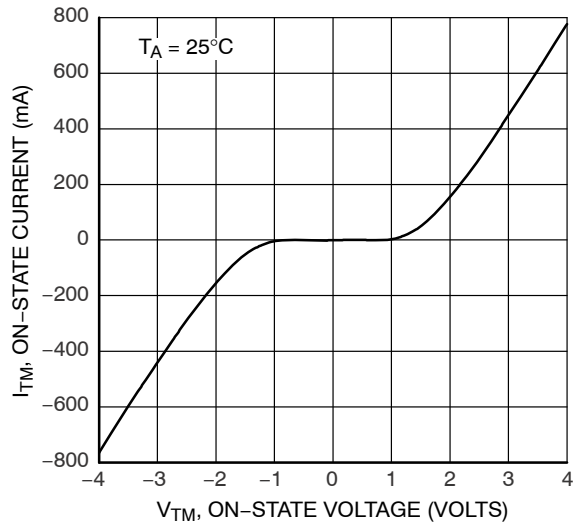

Figure 6. On-State Characteristics

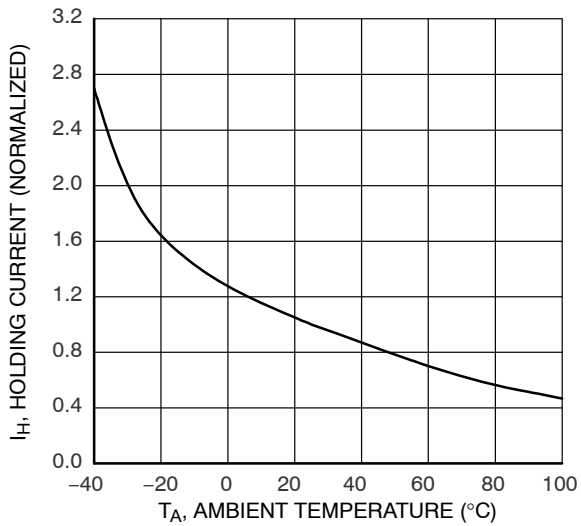

Figure 7. I_H , Holding Current vs. Temperature

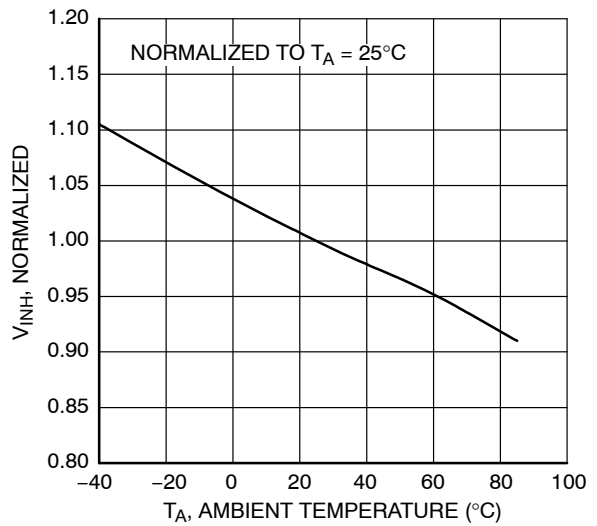

Figure 8. Inhibit Voltage vs. Temperature

APPLICATION INFORMATION

Basic Applications

Typical circuit for use when hot line switching is required. In this circuit the “hot” side of the line is switched and the load connected to the cold or neutral side. The load may be connected to either the neutral or hot line.

R_{in} is calculated so that I_F is equal to the rated I_{FT} of the part, 15 mA for the MOC3061M, 10 mA for the MOC3062M, or 5 mA for the MOC3063M.

The 39 Ω resistor and 0.01 μF capacitor are for snubbing of the triac and is often, but not always, necessary depending upon the particular triac and load used.

Suggested method of firing two, back-to-back SCR's with a ON Semiconductor triac driver. Diodes can be 1N4001; resistors, R1 and R2, are optional 330 Ω .

NOTE: This optoisolator should not be used to drive a load directly. It is intended to be a trigger device only.

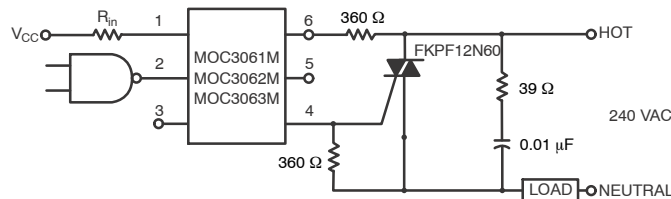

Figure 9. Hot-Line Switching Application Circuit

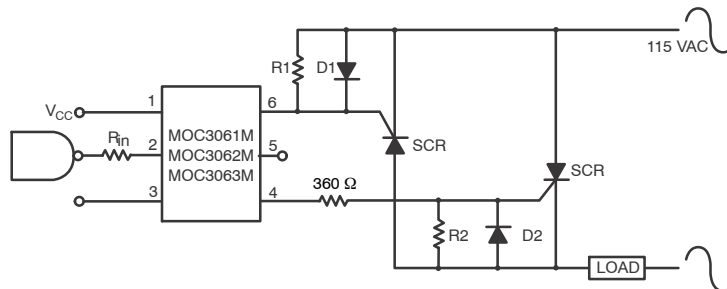
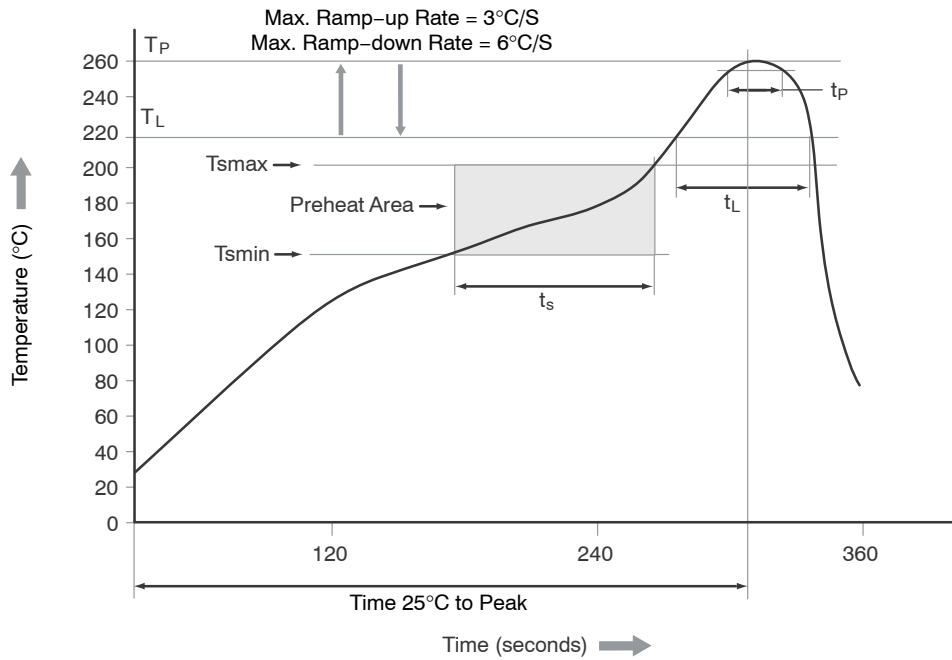

Figure 10. Inverse-Parallel SCR Driver Circuit

MOC3061M, MOC3062M, MOC3063M, MOC3162M, MOC3163M



Profile Feature	Pb-Free Assembly Profile
Temperature Minimum (T _{smin})	150°C
Temperature Maximum (T _{smax})	200°C
Time (t _s) from (T _{smin} to T _{smax})	60 seconds to 120 seconds
Ramp-up Rate (T _L to T _P)	3°C/second maximum
Liquidous Temperature (T _L)	217°C
Time (t _L) Maintained Above (T _L)	60 seconds to 150 seconds
Peak Body Package Temperature	260°C +0°C / -5°C
Time (t _p) within 5°C of 260°C	30 seconds
Ramp-down Rate (T _P to T _L)	6°C/second maximum
Time 25°C to Peak Temperature	8 minutes maximum

Figure 11. Reflow Profile

MOC3061M, MOC3062M, MOC3063M, MOC3162M, MOC3163M

ORDERING INFORMATION (Note 5)

Part Number	Package	Shipping [†]
MOC3061M	DIP 6-Pin (Pb-Free)	50 Units / Tube
MOC3061SM	SMT 6-Pin (Lead Bend) (Pb-Free)	50 Units / Tube
MOC3061SR2M	SMT 6-Pin (Lead Bend) (Pb-Free)	1000 / Tape & Reel
MOC3061VM	DIP 6-Pin, DIN EN/IEC60747-5-5 Option (Pb-Free)	50 Units / Tube
MOC3061SVM	SMT 6-Pin (Lead Bend), DIN EN/IEC60747-5-5 Option (Pb-Free)	50 Units / Tube
MOC3061SR2VM	SMT 6-Pin (Lead Bend), DIN EN/IEC60747-5-5 Option (Pb-Free)	1000 / Tape & Reel
MOC3061TVM	DIP 6-Pin, 0.4" Lead Spacing, DIN EN/IEC60747-5-5 Option (Pb-Free)	50 Units / Tube

[†]For information on tape and reel specifications, including part orientation and tape sizes, please refer to our Tape and Reel Packaging Specifications Brochure, BRD8011/D.

5. The product orderable part number system listed in this table also applies to the MOC3062M, MOC3063M, MOC3162M, and MOC3163M product families.

MECHANICAL CASE OUTLINE

PACKAGE DIMENSIONS

ON Semiconductor®



PDIP6 8.51x6.35, 2.54P
CASE 646BX
ISSUE O

DATE 31 JUL 2016



NOTES:

- A) NO STANDARD APPLIES TO THIS PACKAGE.
- B) ALL DIMENSIONS ARE IN MILLIMETERS.
- C) DIMENSIONS ARE EXCLUSIVE OF BURRS, MOLD FLASH, AND TIE BAR EXTRUSION

DOCUMENT NUMBER:	98AON13449G	Electronic versions are uncontrolled except when accessed directly from the Document Repository. Printed versions are uncontrolled except when stamped "CONTROLLED COPY" in red.
DESCRIPTION:	PDIP6 8.51X6.35, 2.54P	PAGE 1 OF 1

ON Semiconductor and are trademarks of Semiconductor Components Industries, LLC dba ON Semiconductor or its subsidiaries in the United States and/or other countries. ON Semiconductor reserves the right to make changes without further notice to any products herein. ON Semiconductor makes no warranty, representation or guarantee regarding the suitability of its products for any particular purpose, nor does ON Semiconductor assume any liability arising out of the application or use of any product or circuit, and specifically disclaims any and all liability, including without limitation special, consequential or incidental damages. ON Semiconductor does not convey any license under its patent rights nor the rights of others.

MECHANICAL CASE OUTLINE

PACKAGE DIMENSIONS

ON Semiconductor®



PDIP6 8.51x6.35, 2.54P

CASE 646BY

ISSUE A

DATE 15 JUL 2019



NOTES:

1. DIMENSIONING AND TOLERANCING PER ASME Y14.5M, 2009.
2. CONTROLLING DIMENSION: MILLIMETERS
3. DIMENSIONS A, A1, AND L ARE MEASURED WITH THE PACKAGE SEATED.
4. DIMENSIONS D, D1, AND E1 DO NOT INCLUDE MOLD FLASH OR PROTRUSIONS. MOLD FLASH OR PROTRUSIONS ARE NOT TO EXCEED 2.54mm.
5. PACKAGE CONTOUR IS OPTIONAL (ROUNDED OR SQUARE CORNERS).
6. CENTER LINE OF CORNER LEADS ARE LOCATED BY LOCATING THE CENTER OF FEATURE b2 AND b3.

DIM	MILLIMETERS		
	MIN.	NOM.	MAX.
A	---	---	4.80
A1	0.38	---	---
A2	3.28	3.40	3.53
A3	2.49 REF		
A4	1.89 REF		
b	0.41	0.46	0.51
b1	0.76	0.92	1.14
b2	0.25	0.28	0.36
b3	1.02	1.40	1.78
b4	1.778 REF		
c	0.20	0.25	0.30
D	8.13	8.51	8.89
D1	0.86 REF		
E	6.10	6.35	6.60
E1	8.43	9.17	9.90
E2	8.13 REF		
e	2.54 BSC		
L	0.16	0.52	0.88

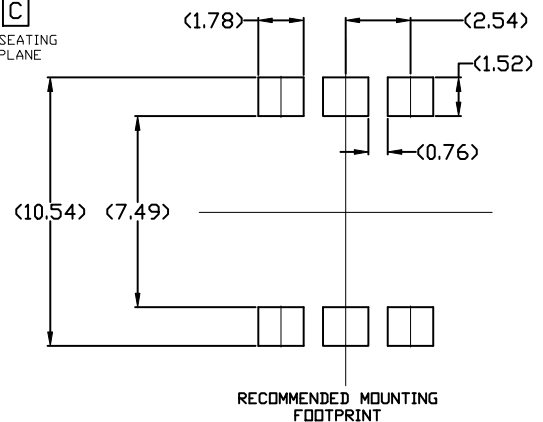

For additional information on our Pb-Free strategy and soldering details, please download the ON Semiconductor Soldering and Mounting Techniques Reference Manual, SOLDERM/D.

DOCUMENT NUMBER:	98AON13450G	Electronic versions are uncontrolled except when accessed directly from the Document Repository. Printed versions are uncontrolled except when stamped "CONTROLLED COPY" in red.
DESCRIPTION:	PDIP6 8.51x6.35, 2.54P	PAGE 1 OF 1

ON Semiconductor and are trademarks of Semiconductor Components Industries, LLC dba ON Semiconductor or its subsidiaries in the United States and/or other countries. ON Semiconductor reserves the right to make changes without further notice to any products herein. ON Semiconductor makes no warranty, representation or guarantee regarding the suitability of its products for any particular purpose, nor does ON Semiconductor assume any liability arising out of the application or use of any product or circuit, and specifically disclaims any and all liability, including without limitation special, consequential or incidental damages. ON Semiconductor does not convey any license under its patent rights nor the rights of others.

MECHANICAL CASE OUTLINE
PACKAGE DIMENSIONS

ON Semiconductor®



PDIP6 8.51x6.35, 2.54P
CASE 646BZ
ISSUE O

DATE 31 JUL 2016

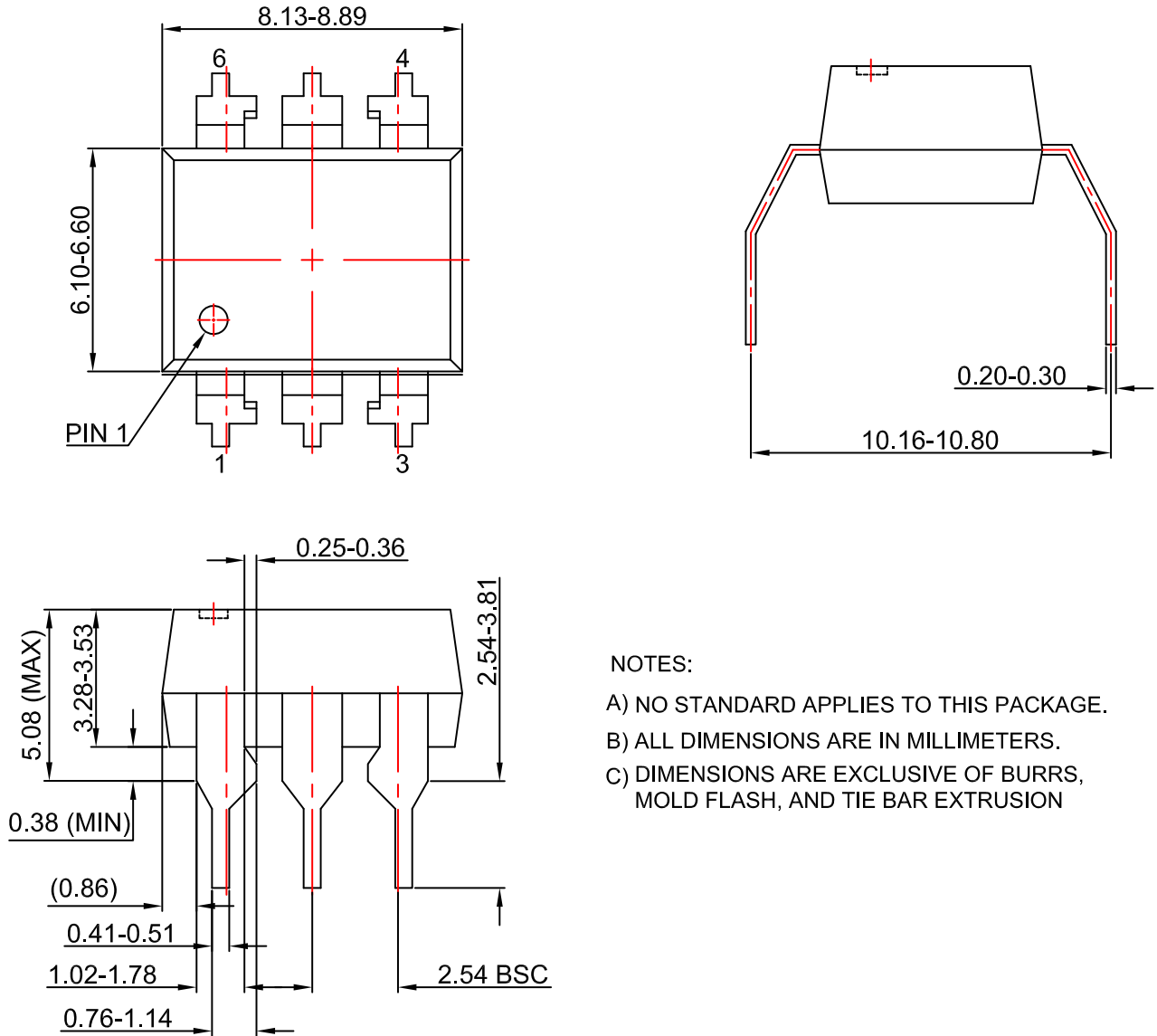

NOTES:

- A) NO STANDARD APPLIES TO THIS PACKAGE.
- B) ALL DIMENSIONS ARE IN MILLIMETERS.
- C) DIMENSIONS ARE EXCLUSIVE OF BURRS, MOLD FLASH, AND TIE BAR EXTRUSION

DOCUMENT NUMBER:	98AON13451G	Electronic versions are uncontrolled except when accessed directly from the Document Repository. Printed versions are uncontrolled except when stamped "CONTROLLED COPY" in red.
DESCRIPTION:	PDIP6 8.51X6.35, 2.54P	PAGE 1 OF 1

ON Semiconductor and are trademarks of Semiconductor Components Industries, LLC dba ON Semiconductor or its subsidiaries in the United States and/or other countries. ON Semiconductor reserves the right to make changes without further notice to any products herein. ON Semiconductor makes no warranty, representation or guarantee regarding the suitability of its products for any particular purpose, nor does ON Semiconductor assume any liability arising out of the application or use of any product or circuit, and specifically disclaims any and all liability, including without limitation special, consequential or incidental damages. ON Semiconductor does not convey any license under its patent rights nor the rights of others.