

DESCRIPTION

The MP1400 is a monolithic negative DCDC power converter with built-in internal power MOSFET. The DC-DC IC has a tiny surface mount 0.8mm x 1.6mm 8-ball CSP package. It achieves up to 600mA peak output current from a 2.7V to 7V input voltage. The output voltage can be regulated from -0.9V to -6V.

The 1500 kHz switching frequency allows for smaller external components producing a compact solution for a wide range of load currents. The internal compensation and soft start minimizes the external component count and limits the inrush current during startup. Fault condition protection includes cycle-by-cycle current limiting and thermal shutdown.

FEATURES

- Wide 2.7V to 7V Operating Input Range Output Adjustable from -0.9V to -6V
- Up to 600mA Peak Output Current
- 300mΩ High Side MOSFET On Resistance
- Default 1.5MHz Switching Frequency
- Ground Reference Enable
- Cycle-by-Cycle Over Current Protection
- Short Circuit Protect with Hiccup Mode
- Output Voltage Discharge
- Output Over Voltage Protection
- Available in a 0.8mm x 1.6mm 8-ball CSP Package

APPLICATIONS

- General Negative Voltage
- HDD
- Small OLED Panel

All MPS parts are lead-free, halogen free, and adhere to the RoHS directive. For MPS green status, please visit MPS website under Quality Assurance.

"MPS" and "The Future of Analog IC Technology" are Registered Trademarks of Monolithic Power Systems, Inc.

TYPICAL APPLICATION

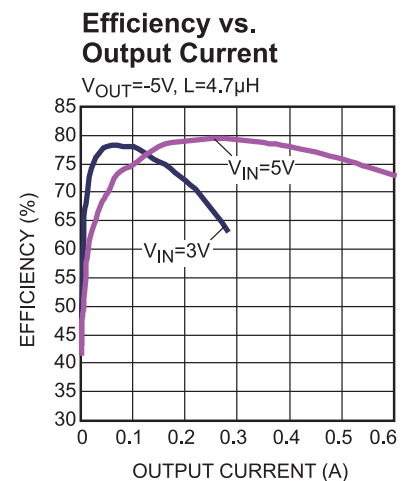
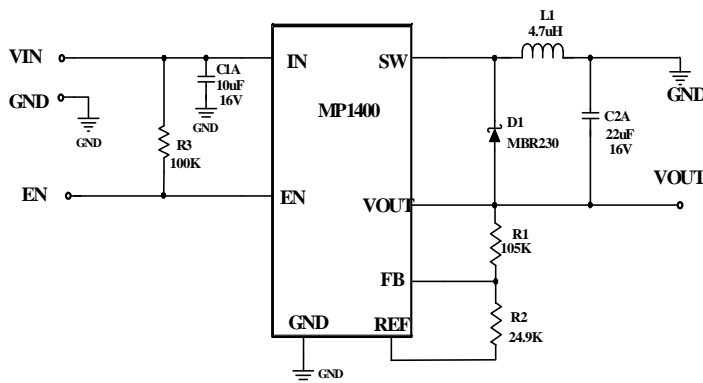

ORDERING INFORMATION

Part Number*	Package	Top Marking
MP1400GC	CSP 0.8mm x 1.6mm	BT

* For Tape & Reel, add suffix -Z (e.g. MP1400GC-Z);

PACKAGE REFERENCE

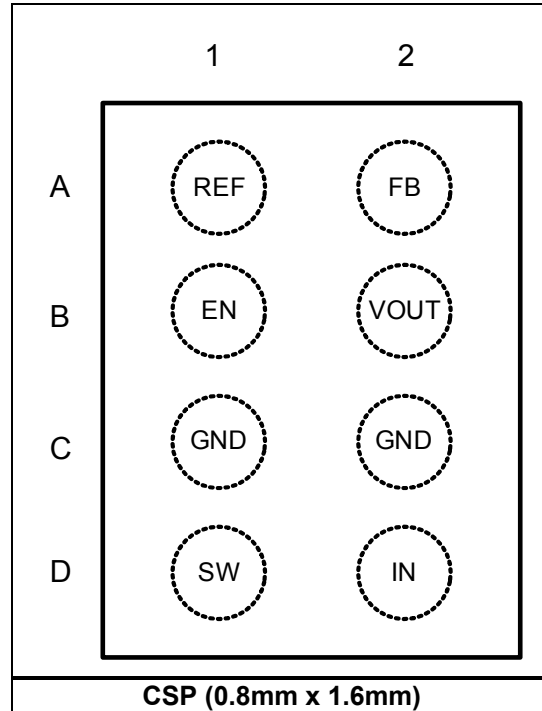

ABSOLUTE MAXIMUM RATINGS ⁽¹⁾

Supply Voltage V_{IN}	7.5V
V_{SW}	
V_{OUT} -0.7V (-8V for <10ns) to 8V (9V for <10ns)	
Output Voltage V_{OUT}	-6.5V
All Other Pins	-0.3V to 6.5 V
Junction Temperature	150°C
Lead Temperature	260°C
Continuous Power Dissipation ($T_A = +25^\circ\text{C}$) ⁽²⁾	0.75W
Storage Temperature	-65°C to +150°C

Recommended Operating Conditions ⁽³⁾

Supply Voltage V_{IN}	2.7V to 7V
Output Voltage V_{OUT}	-0.9V to -6V
Operating Junction Temp. (T_J)	-40°C to +125°C

Thermal Resistance ⁽⁴⁾	θ_{JA}	θ_{JC}
CSP8	170.....na...	°C/W

Notes:

- Exceeding these ratings may damage the device.
- The maximum allowable power dissipation is a function of the maximum junction temperature T_J (MAX), the junction-to-ambient thermal resistance θ_{JA} , and the ambient temperature T_A . The maximum allowable continuous power dissipation at any ambient temperature is calculated by P_D (MAX) = $(T_J$ (MAX)- T_A)/ θ_{JA} . Exceeding the maximum allowable power dissipation will cause excessive die temperature, and the regulator will go into thermal shutdown. Internal thermal shutdown circuitry protects the device from permanent damage.
- The device is not guaranteed to function outside of its operating conditions.
- Measured on JESD51-7, 4-layer PCB.

ELECTRICAL CHARACTERISTICS

$V_{IN} = 3.7V$, $T_A = +25^{\circ}C$, unless otherwise noted.

Parameter	Symbol	Condition	Min	Typ	Max	Units
Reference Voltage	V_{REF}	$2.7V \leq V_{IN} \leq 7V$	1.178	1.190	1.202	V
Feedback Current	I_{FB}	$V_{FB} = 0V$		10	50	nA
FB Voltage	V_{FB}			0	20	mV
PFET Switch On Resistance ⁽⁵⁾	R_{DSON_P}	$V_{IN}=5V$		300		m Ω
Switch Leakage		$V_{EN} = 0V$, $V_{IN} = 6V$ $V_{SW} = 0V$		0	0.1	μA
PFET Current Limit			1	1.6		A
Maximum Duty Cycle	D_{MAX}		70	85		%
Minimum On Time ⁽⁵⁾				100		ns
Switching Frequency	F_s		1200	1500	1800	kHz
Soft-Start Time	T_{SS-ON}	No load		0.5		ms
Output Voltage Discharge Current	I_{DIS}	$EN=0V, V_{OUT}=-1V$		25		mA
Under Voltage Lockout Threshold Rising			2.35	2.45	2.55	V
Under Voltage Lockout Threshold Hysteresis				200		mV
EN Input Logic Low Voltage					0.4	V
EN Input Logic High Voltage			1.2			V
EN Hysteresis				100		mV
EN Input Current		$V_{EN}=2V$		1.7		μA
		$V_{EN}=0V$		0		nA
Supply Current (Shutdown)		$V_{EN}=0V$		0	0.2	μA
Supply Current (Quiescent)		$V_{EN}=2V$, $V_{FB}=-0.1V$, REF pin float, no switching		200	250	μA
Over Voltage Threshold				-6.5		V
Over Voltage Threshold Hysteresis				300		mV
Thermal Shutdown				160		$^{\circ}C$
Thermal Hysteresis ⁽⁶⁾				15		$^{\circ}C$

Notes:

- 5) Guaranteed by Characterization Test
- 6) Guaranteed by design

TYPICAL PERFORMANCE CHARACTERISTICS

$V_{IN} = 5V$, $V_{OUT} = -5V$, $L = 4.7\mu H$, $C_{OUT} = 3 \times 22\mu F$, $T_A = +25^\circ C$, unless otherwise noted.

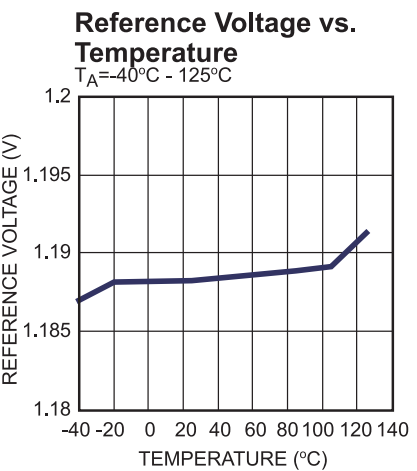
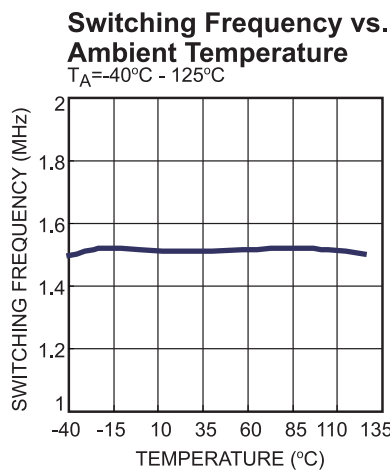
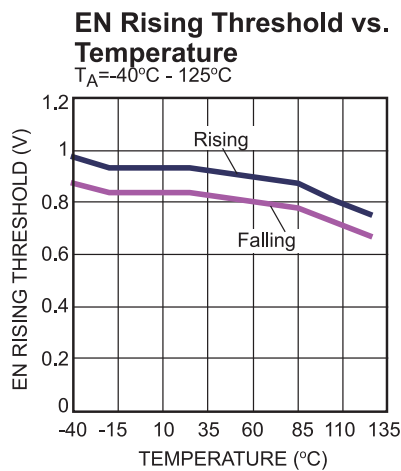
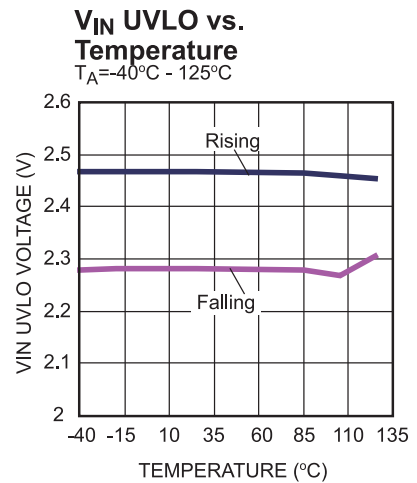
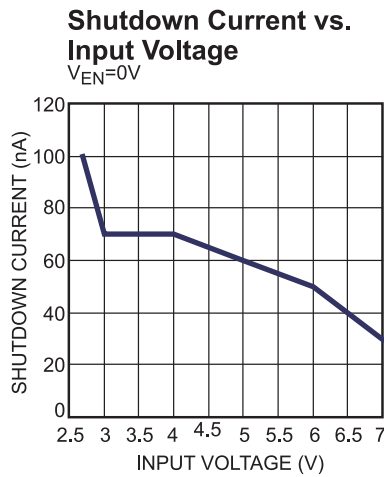
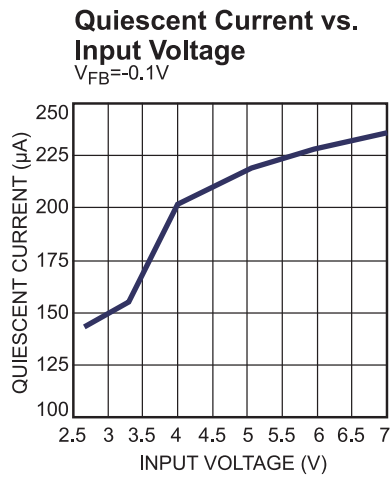
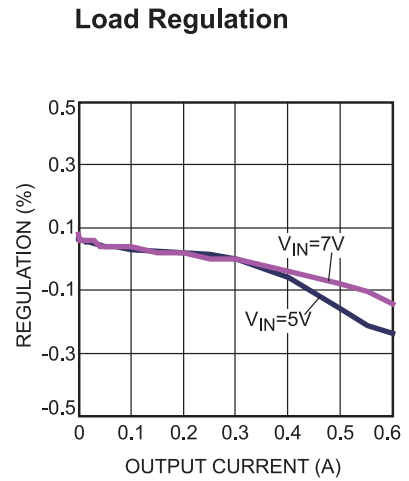
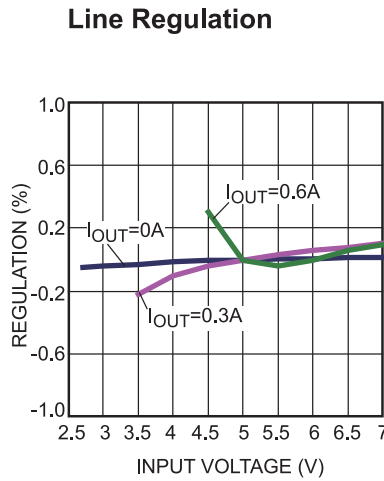
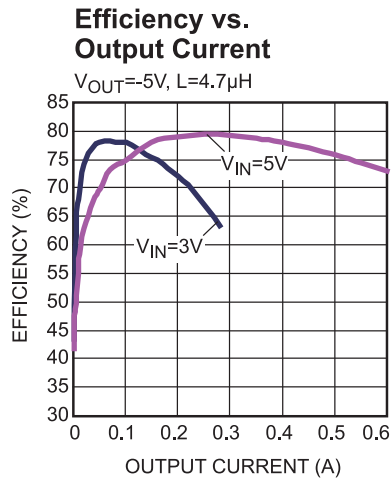

TYPICAL PERFORMANCE CHARACTERISTICS *(continued)*

$V_{IN} = 5V$, $V_{OUT} = -5V$, $L = 4.7\mu H$, $C_{OUT} = 3 \times 22\mu F$, $T_A = +25^\circ C$, unless otherwise noted.

Case Temperature Rise vs. Output Current

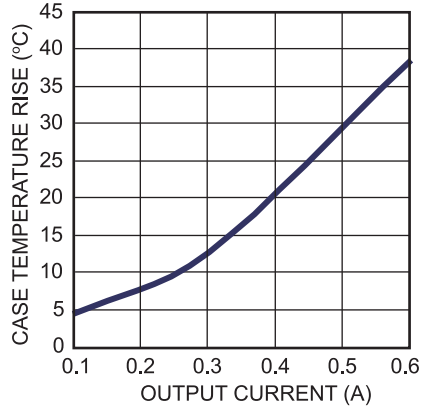

Maximum Output Current vs. Input Voltage

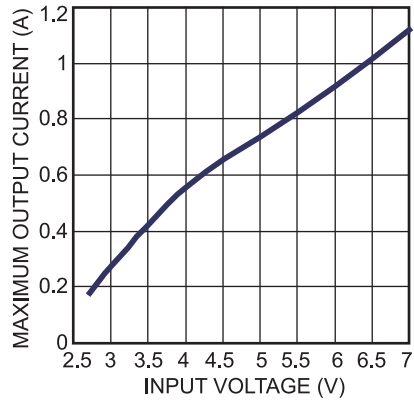

TYPICAL PERFORMANCE CHARACTERISTICS

Performance waveforms are tested on the evaluation board of the Design Example section.
 $V_{IN} = 5V$, $V_{OUT} = -5V$, $L = 4.7\mu H$, $C_{OUT} = 3 \times 22\mu F$, $T_A = +25^\circ C$, unless otherwise noted.

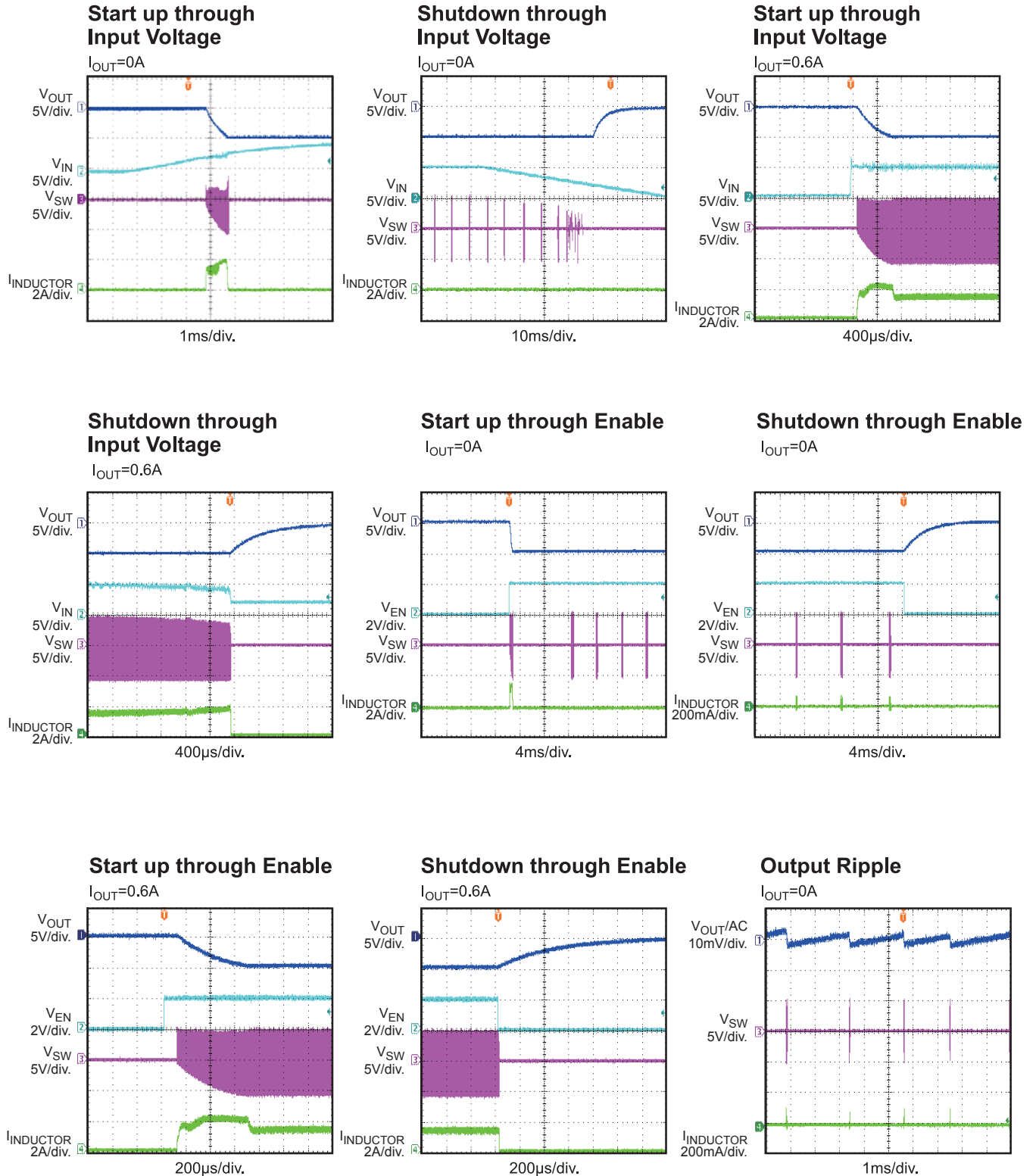

TYPICAL PERFORMANCE CHARACTERISTICS *(continued)*

Performance waveforms are tested on the evaluation board of the Design Example section. $V_{IN} = 5V$, $V_{OUT} = -5V$, $L = 4.7\mu H$, $C_{OUT} = 3 \times 22\mu F$, $T_A = +25^\circ C$, unless otherwise noted.

Output Ripple

$I_{OUT} = 0.04A$

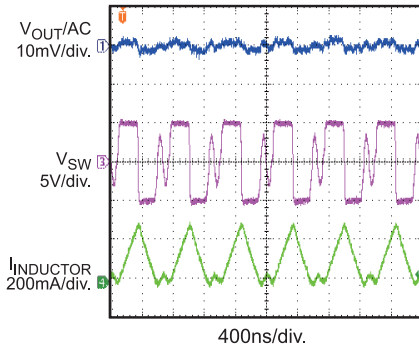

Output Ripple

$I_{OUT} = 0.6A$

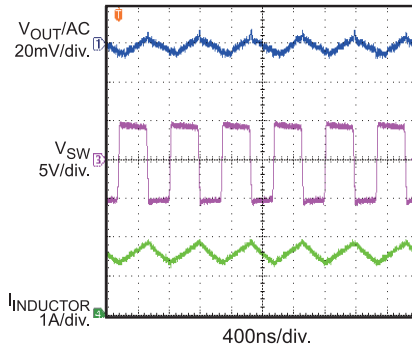

Over Voltage Protection

$I_{OUT} = 0.6A$

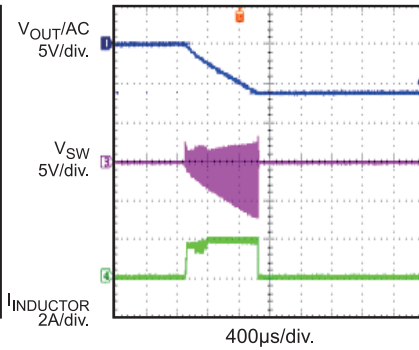

Transient Response

$I_{OUT} = 0.3A$ to $0.6A$, $2.5A/\mu s$

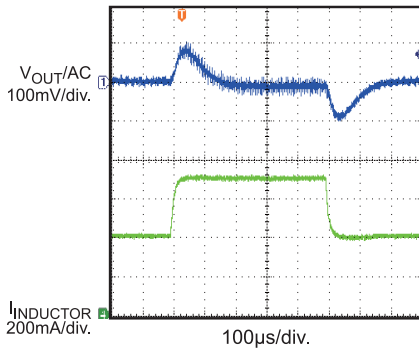

Short Circuit Entry

$I_{OUT} = 0A$

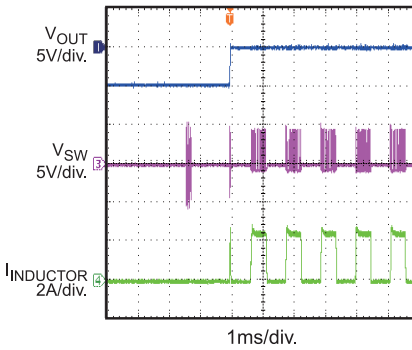

Short Circuit Recovery

$I_{OUT} = 0A$

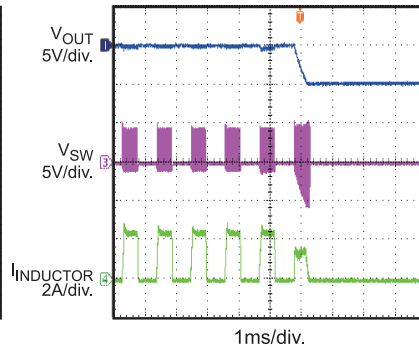

Bode Plot

$I_{OUT} = 0.6A$

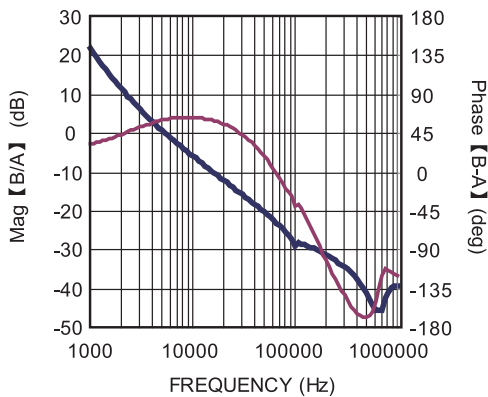

PIN FUNCTIONS

Pin #	Name	Description
A1	REF	Internal 1.19V reference voltage.
A2	FB	Feedback pin. An external resistor divider from the output to GND, tapped to the FB pin, sets the output voltage.
B1	EN	On/Off Control.
B2	VOOUT	Output Voltage power rail and input sense pin for output voltage. Connect load to this pin. Output capacitor is needed to decrease the output voltage ripple.
C1, C2	GND	Analog Ground Pin.
D1	SW	Output Switching Node. SW is the drain of the internal high-side P-Channel MOSFET. Connect the inductor to SW to complete the converter.
D2	IN	Supply Voltage. The MP1400 operates from a +2.7V to +7V unregulated input. Decouple capacitor is needed to prevent large voltage spikes from appearing at the input.

FUNCTIONAL BLOCK DIAGRAM

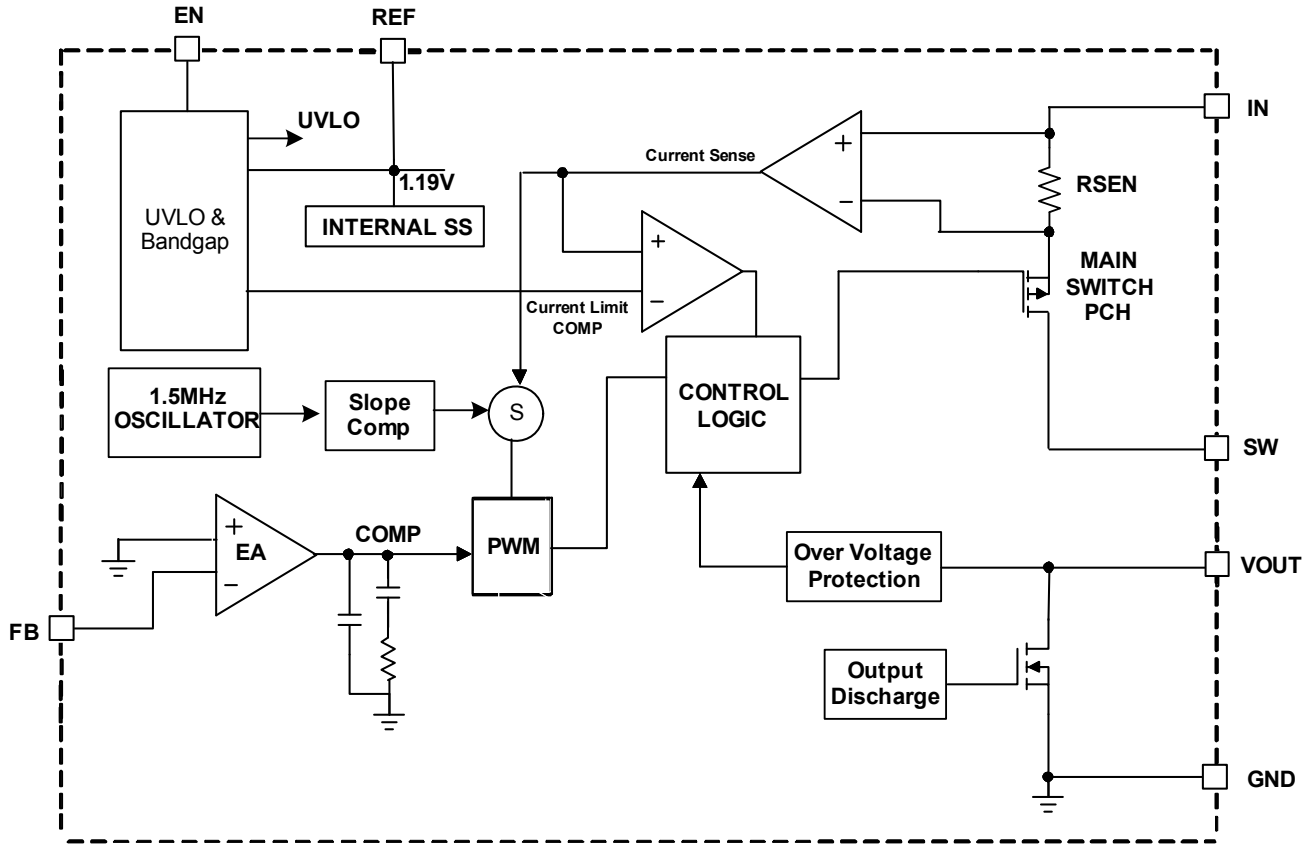

Figure 1: Functional Block Diagram

OPERATION

The MP1400 is a monolithic negative DCDC power converter with built-in internal power MOSFET. The DC-DC IC has a tiny surface mount 0.8mm x 1.6mm 8-ball CSP package and is optimized for low voltage powered applications where small size are critical. It achieves up to 600mA peak output current from a 2.7V to 7V input voltage. The output voltage can be regulated from -0.9V to -6V. The built-in 300m Ω PFET can provide high efficiency and eliminates an external boost capacitor. The duty cycle D of negative converter is defined as:

$$D = T_{ON} \times f_{OSC} \times 100\% \approx \frac{-V_{OUT}}{V_{IN} - V_{OUT}} \times 100\%$$

Where T_{ON} is the main switch on time, f_{OSC} is the oscillator frequency (1.5MHz), V_{OUT} is the output voltage and V_{IN} is the input voltage.

Current Mode PWM Control

Slope compensated current mode PWM control provides stable switching and cycle-by-cycle current limit for superior load and line response and protection of the internal main switch and rectifier diode. The MP1400 switches at a constant frequency (1.5MHz) and regulates the output voltage. During each cycle the PWM comparator modulates the power transferred to the load by changing the inductor peak current based on the feedback error voltage. During normal operation, the main switch is turned on for a certain time to ramp the inductor current at each rising edge of the internal oscillator, and switched off when the peak inductor current is above the error voltage. When the main switch is off, the rectifier diode will supply the current on immediately.

Light Load Operation

In light load condition, the load requires less energy so the charged current to inductor is smaller than heavy load. The rectifier diode discharges the inductor current. If the inductor current hit the zero, MP1400 will works in discontinuous conduction mode (DCM) operation.

Startup and Shutdown

When input voltage is greater than the under-voltage lockout threshold (UVLO), typically 2.5V, MP1400 can be enabled by pulling EN pin to higher than 1.2V. Leaving EN pin float or pull down to ground will disable MP1400. There is an internal 1Meg Ohm resistor from EN pin to ground.

When the device is disabled, the part goes into output discharge mode automatically and its internal discharge MOSFET provides a resistive discharge path for the output capacitor.

For the load capability is depending on the input voltage to output voltage ratio. It's strongly recommending to power on VIN quick enough when load is high.

Soft Start

MP1400 has built-in soft start that ramps up the output voltage in a controlled slew rate. During power up, internal soft-start circuitry will limit the amount of in-rush current that drawn from the power supply. The soft start time is about 0.5ms typical.

Current Limit

MP1400 has a typical 1.6A current limit for the main PFET switch. When the PFET hits current limit, MP1400 will touch the hiccup threshold until the current lower down. This will prevent inductor current from continuing to build up which will result in damage of the components.

Output Over Voltage Protection

MP1400 has a built-in output voltage protection block. If the output voltage is lower than -6.5V, the PFET will be turned off immediately. After the output voltage status is removed, the part will re-switches automatically.

Short Circuit Protection

MP1400 enters short circuit protection mode when the current limit is hit, and tries to recover from short circuit with hiccup mode. In short circuit protection, MP1400 will disable output power stage, discharge soft-start cap and then automatically try to soft-start again. If the short circuit condition still holds after soft-start ends, MP1400 repeats this operation cycle till short circuit disappears and output rises back to regulation level.

APPLICATION INFORMATION

COMPONENT SELECTION

Setting the Output Voltage

The external resistor divider is used to set the output voltage (see Typical Application on page 1). The voltage on R1 is 1.19V. There is a REF current on R1 which is decided by R1's resistance. The recommended REF current should be 10µA and R1 resistance should be 120k. Don't set the REF current larger than 70µA. R2 is then given by:

$$R_2 = \frac{-V_{OUT}}{1.19} \cdot R_1$$

The feedback circuit is shown as Figure 2.

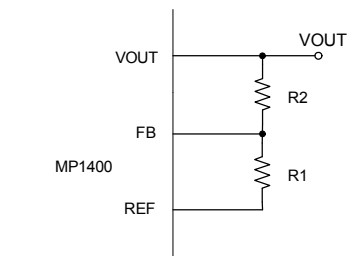

Figure 2: Feedback Network

Table 1 lists the recommended resistors value for common output voltages.

Table 1—Resistor Selection for Common Output Voltages

V _{OUT} (V)	R1 (kΩ)	R2 (kΩ)
-1.8	24.9(1%)	37.4(1%)
-2.5	24.9(1%)	52.3(1%)
-3.3	24.9(1%)	69.8(1%)
-5	24.9(1%)	105(1%)

Selecting the Inductor

A 1µH to 10µH inductor is recommended for most applications. For highest efficiency, the inductor DC resistance should be small enough. For most designs, the inductance value can be derived from the following equation.

$$L_1 = \frac{V_{IN} \cdot V_{OUT}}{\Delta I_L \cdot (V_{OUT} - V_{IN}) \cdot f_{OSC}}$$

Where ΔI_L is the inductor ripple current.

f_{OSC} is switching frequency.

Choose inductor ripple current to be approximately 30% to 80% of the inductor current. The inductor current is:

$$I_L = \frac{V_{IN} - V_{OUT}}{V_{IN}} \cdot I_{OUT}$$

Then the peak inductor current at CCM is:

$$I_{Peak} = I_L + \frac{1}{2} \cdot \Delta I_L$$

High-frequency ferrite-core inductor materials reduce frequency-dependent power losses and improve efficiency compared to cheaper powdered-iron cores. The inductor should have low DCR (inductor series resistance without saturated windings) to reduce the resistive power loss; further reducing the DCR will significantly improve efficiency when $DCR \ll R_{DS-ON}$. Select a large-enough saturation current (I_{SAT}) to support the current peak.

Selecting the Input Capacitor

Low ESR input capacitors reduce input switching noise and reduce the peak current drawn from the battery. It follows the ceramic capacitors are also a good choice for input decoupling and should be located as close as possible to the device. At least a ceramic capacitor larger than 10µF is recommended to put close to the IC.

Setting the Output Capacitor

The output capacitor (C_{OUT}) is required to maintain the DC output voltage. The output capacitor requires a minimum capacitance value of 22µF at the programmed output voltage to ensure stability over the full operating range. A higher capacitance value may be required to lower the output ripple and also the transient response. Low ESR capacitors, such as X5R- or X7R-type ceramic capacitors, are recommended. Assuming that the ESR is zero, estimate the minimum output capacitance to support the ripple in the PWM mode as

$$C_{OUT} = \frac{I_{OUT} \cdot V_{OUT}}{f_{OSC} \cdot \Delta V_{OUT} \cdot (V_{OUT} - V_{IN})}$$

Additional output capacitance may also be required to reduce ripple in DCM mode and to ensure stability in PWM mode, especially at higher output load current.

Power Dissipation

IC power dissipation plays an important role in circuit design—not only because of efficiency concerns, but also because of the chip’s thermal requirements. Several parameters influence power dissipation, such as:

Conduction Loss (Cond)

Dead time (DT)

Switching Loss (SW)

MOSFET Driver Current (DR)

Supply Current (S)

Based on these parameters, we can estimate the power loss to equal:

$$P_{LOSS} = P_{Cond} + P_{DT} + P_{SW} + P_{DR} + P_S$$

PCB Layout

Layout is important, especially for switching power supplies with high switching frequencies; poor layout results in reduced performance, EMI problems, resistive loss, and even system instability.

Following the rules below can help ensure a stable layout design:

1. Connect the GND pin to the large ground plane by point connect mode.
2. Put the input capacitor as close as possible to the VIN pin while keep the GND end of the output capacitor close to the GND end of the input capacitor.
3. Put the cathode of the schottky close to the SW pin and the anode of the schottky close to the output capacitor to minimize parasitic inductance.
4. Route SW away from sensitive analog areas such as FB. It’s not recommended to route SW trace under chip’s bottom side.

Notes:

- 7) The recommended layout is based on the Figure 3 Typical Application circuit on the next page.

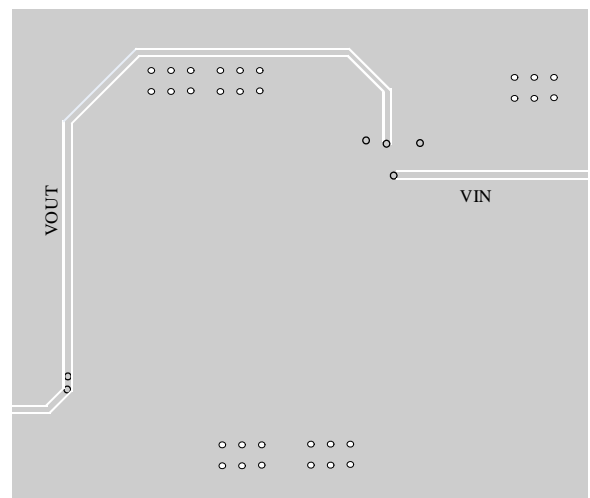
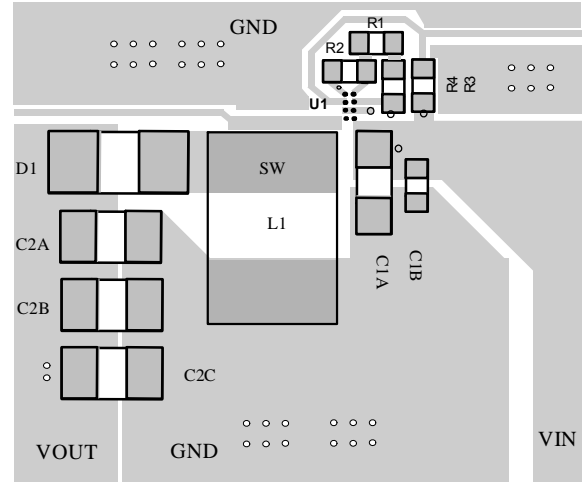

Design Example

Below is a design example following the application guidelines for the specifications:

Table 2: Design Example

V_{IN}	5V
V_{OUT}	-5V
I_o	0.6A

The detailed application schematic is shown in Figure 3. The typical performance and circuit waveforms have been shown in the Typical Performance Characteristics section. For more device applications, please refer to the related Evaluation Board Datasheets.

TYPICAL APPLICATION CIRCUITS

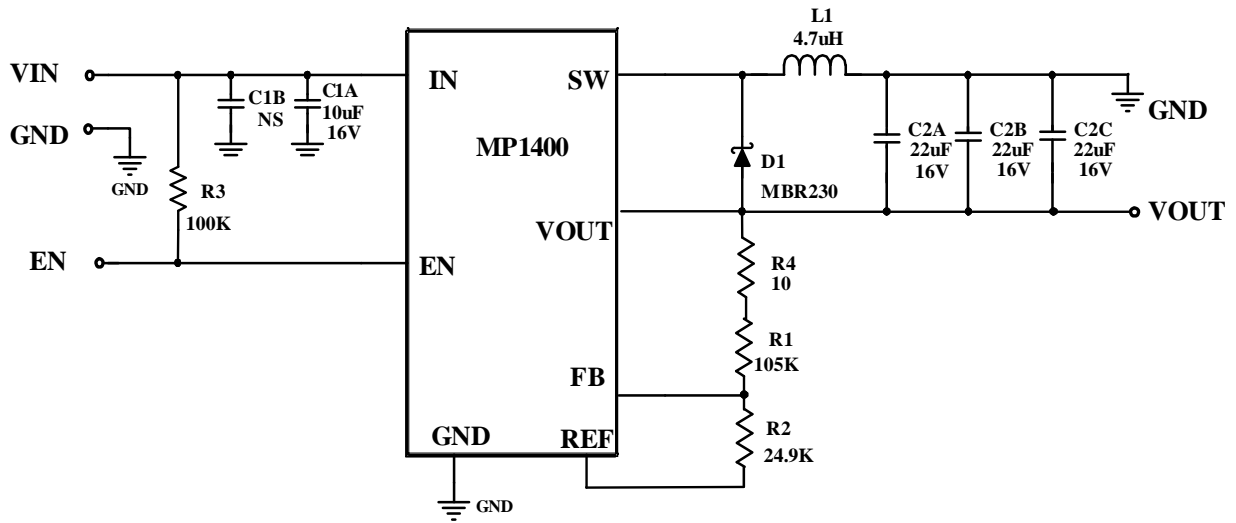

Figure 3: 5V_{IN}, -5V/0.6A Output