



The Future of Analog IC Technology®

MP2015A

24V, 150mA, Low Quiescent Current Linear Regulator

DESCRIPTION

The MP2015A is a low power linear regulator that supplies power to systems with high voltage batteries. It includes a wide 2.5V to 24V input range, low dropout voltage and low quiescent supply current. The low quiescent current and low dropout voltage allow operations at extremely low power levels. Therefore, the MP2015A is an ideal for the low power microcontrollers and the battery-powered equipments.

The MP2015A provides wide variety of fixed output voltage options (if request): 1.8V, 1.9V, 2.3V, 2.5V, 3.0V, 3.3V, 3.45V, 5.0V; and also provides the output adjustable option (from 1.215V to 15V).

The regulator output current is internally limited and the device is protected against over-load and over-temperature conditions.

The MP2015A also includes thermal shutdown and current limiting fault protection, and is available in QFN-6 (2mmx2mm), QFN 8(3mmx3mm), and TSOT23-4 packages.

FEATURES

- 2.5V to 24V Input Range
- 3.3µA Quiescent Supply Current
- Stable With low-value output ceramic capacitor (> 0.47µF)
- 150mA specified current for QFN-6 and QFN-8 Packages
- 100mA specified current for TSOT23-4 Packages
- 700mV Dropout at 150mA Load
- Available in Fixed 3.3V Output and Adjustable Output (1.215V to 15V) versions
- Output ±2% Accuracy for QFN-6 and QFN-8 Packages
- Output ±4% Accuracy TSOT23-4 Packages
- Specified current limit
- Thermal Shutdown and Short-Circuit Protection
- Available in TSOT23-4, QFN-6 (2mmx2mm), or QFN-8 (3mmx3mm) Packages

APPLICATIONS

- Portable/Battery-Powered Equipment
- Ultra low power Microcontrollers
- Cellular Handsets

All MPS parts are lead-free, halogen free, and adhere to the RoHS directive. For MPS green status, please visit MPS website under Quality Assurance.

"MPS" and "The Future of Analog IC Technology" are Registered Trademarks of Monolithic Power Systems, Inc.

TYPICAL APPLICATION

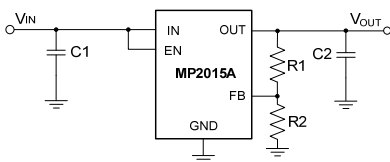

Output Adjustable Version (QFN)

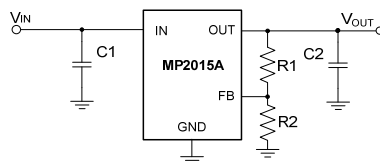

Output Adjustable Version (TSOT)

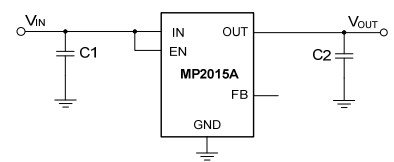

Output Fixed Version (QFN)

ORDERING INFORMATION

Part Number*	Package	Top Marking
MP2015AGQ	QFN-8 (3mmx3mm)	See Below
MP2015AGQ-33	QFN-8 (3mmx3mm)	See Below

* For Tape & Reel, add suffix -Z (e.g. MP2015AGQ-Z);

TOP MARKING (MP2015AGQ)

AMFY
LLL

AMF: product code of MP2015AGQ;
 Y: year code;
 LLL: lot number;

TOP MARKING (MP2015AGQ-33)

ALCY
LLL

ALC: product code of MP2015AGQ-33;
 Y: year code;
 LLL: lot number;

PACKAGE REFERENCE

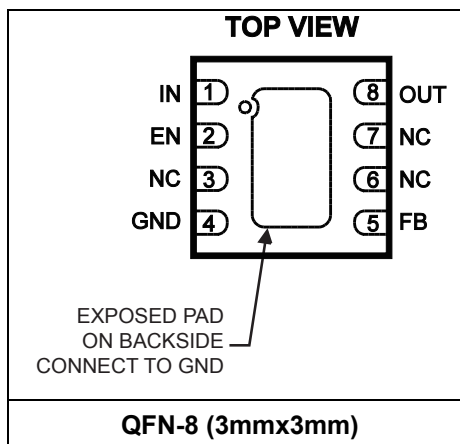

ORDERING INFORMATION

Part Number*	Package	Top Marking
MP2015AGG**	QFN-6 (2mmx2mm)	See Below
MP2015AGG-33**	QFN-6 (2mmx2mm)	See Below

* For Tape & Reel, add suffix -Z (e.g. MP2015AGG-Z);
 ** Pre-release

TOP MARKING (MP2015AGG)

DDY
 LLL

DD: product code of MP2015AGG;
 Y: year code;
 LLL: lot number;

TOP MARKING (MP2015AGG-33)

DCY
 LLL

DC: product code of MP2015AGG-33;
 Y: year code;
 LLL: lot number;

PACKAGE REFERENCE

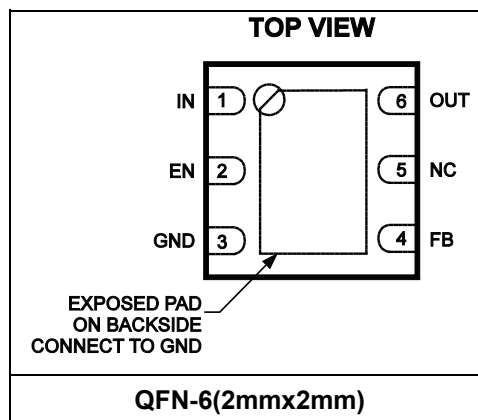

ORDERING INFORMATION

Part Number*	Package	Top Marking
MP2015AGJE	TSOT23-4	See Below

* For Tape & Reel, add suffix -Z (e.g. MP2015AGJE-Z);

TOP MARKING (MP2015AGJE)

| AMFY

AMF: product code of MP2015AGJE;
Y: year code;

PACKAGE REFERENCE

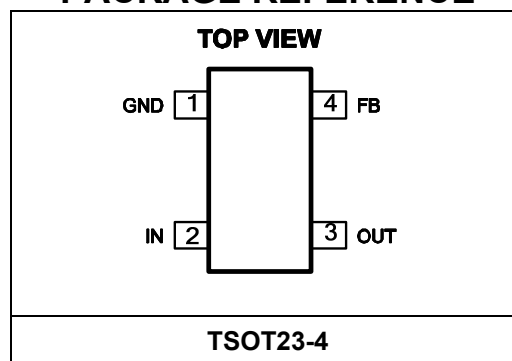

ABSOLUTE MAXIMUM RATINGS ⁽¹⁾

IN, EN	-0.3V to +26V
OUT	-0.3V to +17V
FB	-0.3V to +6V
Lead Temperature	260°C
Storage Temperature.....	-65°C to +150°C
Continuous Power Dissipation (T _A = +25°C) ⁽²⁾	
QFN8(3x3mm)	2.08W
QFN-6(2mmx2mm)	1.25W
TSOT23-4	0.45W

ESD SUSCEPTIBILITY ⁽³⁾

HBM (Human Body Mode)	2kV
MM (Machine Mode)	200V

Recommended Operating Conditions ⁽⁴⁾

Supply Voltage V _{IN}	2.5V to 24V
Output Voltage V _{OUT}	1.215V to 15V
Operating Junction Temp (T _J)	-40°C to +125°C

Thermal Resistance ⁽⁵⁾	θ_{JA}	θ_{JC}
QFN-6 (2mmx2mm).....	80.....	16...°C/W
QFN-8 (3mmx3mm).....	48.....	11...°C/W
TSOT23-4	220.....	110 ..°C/W

Notes:

- 1) Exceeding these ratings may damage the device.
- 2) The maximum allowable power dissipation is a function of the maximum junction temperature T_J (MAX), the junction-to-ambient thermal resistance θ_{JA}, and the ambient temperature T_A. The maximum allowable continuous power dissipation at any ambient temperature is calculated by P_D (MAX) = (T_J (MAX)-T_A)/θ_{JA}. Exceeding the maximum allowable power dissipation will cause excessive die temperature, and the regulator will go into thermal shutdown. Internal thermal shutdown circuitry protects the device from permanent damage.
- 3) Devices are ESD sensitive. Handling precaution recommended.
- 4) The device is not guaranteed to function outside of its operating conditions.
- 5) Measured on JESD51-7, 4-layer PCB.

ELECTRICAL CHARACTERISTICS

$V_{EN}=V_{IN}$, $C_{OUT}=1\mu F$, $T_A=-40^{\circ}C$ to $+125^{\circ}C$, $T_A \leq T_J \leq +150^{\circ}$, unless otherwise noted. Typical values are at $T_A = +25^{\circ}C$.

Parameter	Symbol	Condition	Min	Typ	Max	Units		
Input Voltage	V_{IN}		2.5		24	V		
Output Voltage Range	V_{OUT}		1.215		15	V		
GND Pin Current	I_{GND}	MP2015AGQ/AGJE, $0 < I_{OUT} < 1mA$, $V_{IN}=2.5V$ to $24V$, $V_{OUT}=5V$ ($V_{IN} \geq 6V$) or FB ($V_{IN} < 6V$)		3.3	9	uA		
		MP2015AGQ/AGJE, $1mA < I_{OUT} < 30mA$, $V_{IN}=2.5V$ to $15V$, $V_{OUT}=5V$ ($V_{IN} \geq 6V$) or FB ($V_{IN} < 6V$)		11	22			
		MP2015AGQ, $30mA < I_{OUT} < 150mA$, $V_{IN}=2.5V$, $V_{OUT}=FB$		32	50			
				MP2015AGJE, $30mA < I_{OUT} < 100mA$, $V_{IN}=2.5V$, $V_{OUT}=FB$		35	50	uA
			MP2015AGQ-33, $0mA < I_{OUT} < 1mA$, $V_{IN}=4.3V$ to $24V$		4.4	10		
			MP2015AGQ-33, $1mA < I_{OUT} < 30mA$, $V_{IN}=4.3V$ to $15V$		15	25		
			MP2015AGQ-33, $30mA < I_{OUT} < 150mA$, $V_{IN}=4.3V$		35	50		
Shutdown Supply Current	I_{SHDN}	$V_{EN}=0$, $V_{IN}=2.5V$ to $24V$		3	9	uA		
Load Current limit	I_{LIMIT}	MP2015AGQ-33, $V_{OUT}=0V$, $V_{IN}=4.3V$ to $15V$	160	270	400	mA		
		MP2015AGQ, $V_{OUT}=0V$, $V_{IN}=6V$ to $15V$	160	270	400	mA		
		MP2015AGJE, $V_{OUT}=0V$, $V_{IN}=6V$ to $15V$	120	270	400	mA		
Output Voltage Accuracy		MP2015AGQ-33, $V_{IN}=4.3V$, $I_{OUT}=0$	3.234	3.3	3.366	V		
FB Voltage	V_{FB}	MP2015AGQ/AGQ-33, FB=OUT, $V_{IN}=5V$, $I_{OUT}=0$	1.191	1.215	1.239	V		
		MP2015AGJE, FB=OUT, $V_{IN}=6V$, $I_{OUT}=0$, $T_A = +25^{\circ}C$	1.191	1.215	1.239			
		MP2015AGJE, FB=OUT, $V_{IN}=6V$, $I_{OUT}=0$, $T_A = -40^{\circ}C$ to $+125^{\circ}C$	1.167	1.215	1.263			
Dropout Voltage $V_{IN}=V_{OUT(NOM)}-0.1V$	$V_{DROPOUT}$	MP2015AGQ, $I_{OUT}=150mA$, $V_{OUT(NOM)}=5V$		600	1100	mV		
		MP2015AGQ-33, $I_{OUT}=150mA$, $V_{OUT(NOM)}=3.3V$		700	1100	mV		
		MP2015AGJE, $I_{OUT}=100mA$, $V_{OUT(NOM)}=5V$		400	900	mV		

ELECTRICAL CHARACTERISTICS (continued)

$V_{EN}=V_{IN}$, $C_{OUT}=1\mu F$, $T_A=-40^{\circ}C$ to $+125^{\circ}C$, $T_A \leq T_J \leq +150^{\circ}$, unless otherwise noted. Typical values are at $T_A = +25^{\circ}C$.

Parameter	Symbol	Condition	Min	Typ	Max	Units
FB Pin Input Current	I_{FB}	MP2015A-33, $V_{FB}=1.3V$, $V_{IN}=6V$, OUT floating.	0.88	1.3	1.72	μA
		MP2015A, $V_{FB}=1.3V$, $V_{IN}=6V$, OUT floating.	-50	0	50	nA
Line Regulation ⁽⁶⁾		$V_{IN}=2.5V$ to 24V, $I_{OUT}=1mA$, OUT=FB		0.01	0.05	%/V
Load Regulation ⁽⁷⁾		MP2015AGQ, $I_{OUT}=100\mu A$ to 150mA, $V_{IN}=4.3V$ to 6V		0.005	0.012	%/mA
		MP2015AGQ-33, $I_{OUT}=100\mu A$ to 150mA, $V_{IN}=4.3V$ to 6V		0.005	0.015	%/mA
		MP2015AGJE, $I_{OUT}=100\mu A$ to 100mA, $V_{IN}=3V$ to 6V		0.005	0.012	%/mA
Output Voltage PSRR ⁽⁸⁾		100Hz, $C_{IN}=100pF$, $C_{OUT}=4.7\mu F$, $I_{OUT}=10mA$, $V_{IN}=6V$, $V_{OUT}=5V$		58		dB
		1kHz, $C_{IN}=100pF$, $C_{OUT}=4.7\mu F$, $I_{OUT}=10mA$, $V_{IN}=6V$, $V_{OUT}=5V$		41		dB
		100kHz, $C_{IN}=100pF$, $C_{OUT}=4.7\mu F$, $I_{OUT}=10mA$, $V_{IN}=6V$, $V_{OUT}=5V$		55		dB
Startup Response Time		MP2015AGQ/AGJE, $I_{OUT}=100mA$, $C_{OUT}=6.8\mu F$, $V_{OUT}=5V$			3	ms
		MP2015AGQ-33, $I_{OUT}=10mA$, $C_{OUT}=6.8\mu F$, $V_{OUT}=3.3V$			1.8	ms
EN Rising Threshold ⁽⁹⁾	EN_{TH_R}	$V_{IN}=2.5V$ to 24V	1.32	1.48	1.64	V
EN Falling Threshold ⁽⁹⁾	EN_{TH_F}	$V_{IN}=2.5V$ to 24V	1.1	1.26	1.42	V
EN Pin Input Current ⁽⁹⁾	I_{EN}	$V_{EN}=0$ or 15V, $V_{IN}=2.5V$ to 24V			0.1	μA
Thermal Shutdown ⁽⁸⁾	TSD		150	165		C
Thermal Shutdown Hysteresis	ΔTSD			20		C

Notes:

$$6) \text{ Line Regulation} = \frac{|V_{OUT[V_{IN(MAX)}]} - V_{OUT[V_{IN(MIN)}]}|}{(V_{IN(MAX)} - V_{IN(MIN)}) \times V_{OUT(NOM)}} \times (\% / V)$$

$$7) \text{ Load Regulation} = \frac{|V_{OUT[I_{OUT(MAX)}]} - V_{OUT[I_{OUT(MIN)}]}|}{(I_{OUT(MAX)} - I_{OUT(MIN)}) \times V_{OUT(NOM)}} \times (\% / mA)$$

8) Derived from bench characterization. Not tested in production.

9) TSOT23-4 package has no EN pin

TYPICAL CHARACTERISTICS

$C_{IN} = 1\mu F$, $C_{OUT} = 4.7\mu F$, $V_{OUT} = 5V$, $T_A = +25^\circ C$, unless otherwise noted.

Dropout Voltage vs. Junction Temperature
 $V_{OUT} = 5V$

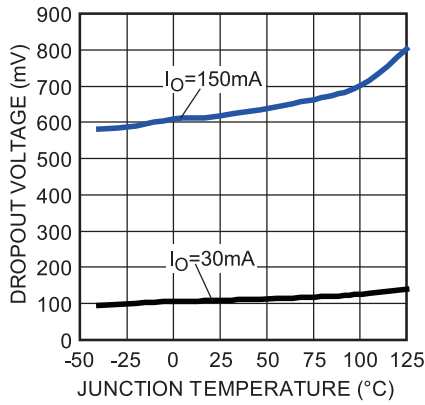

Feedback Voltage vs. Junction Temperature
 $V_{IN} = 6V$

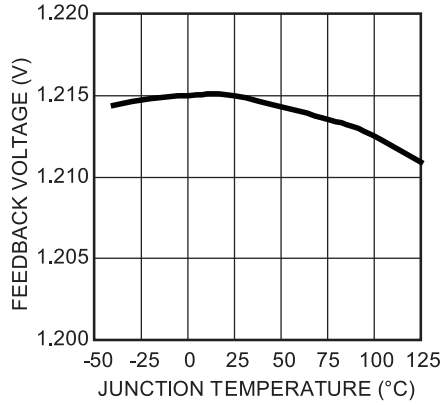

Current Limit vs. Junction Temperature
 $V_{IN} = 6V$

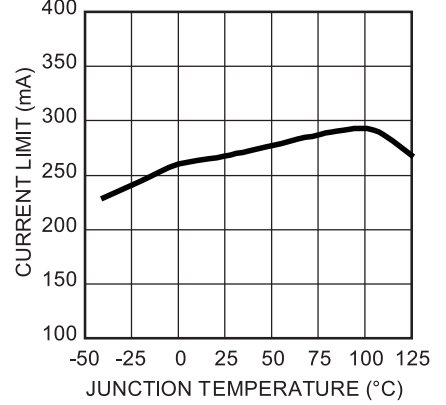

TYPICAL PERFORMANCE CHARACTERISTICS

$C_{IN} = 1\mu F$, $C_{OUT} = 4.7\mu F$, $V_{OUT}=5V$, $T_A = +25^\circ C$, unless otherwise noted

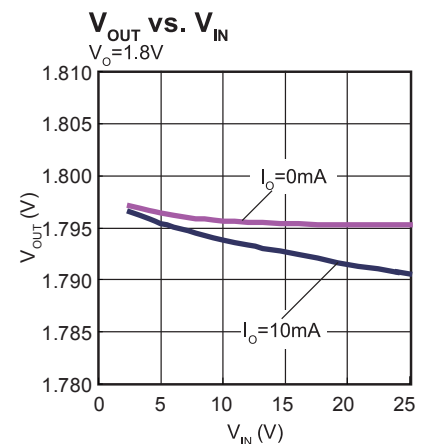
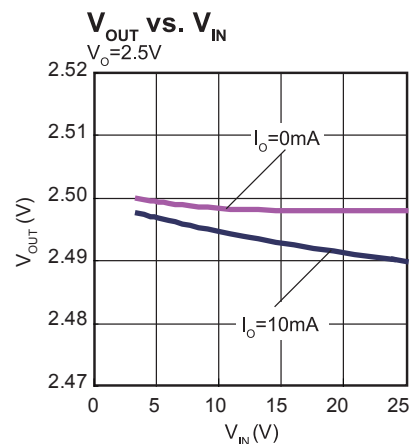
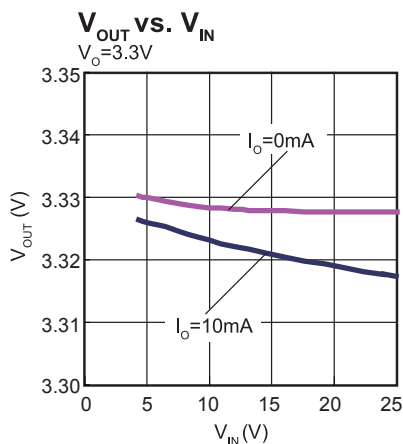
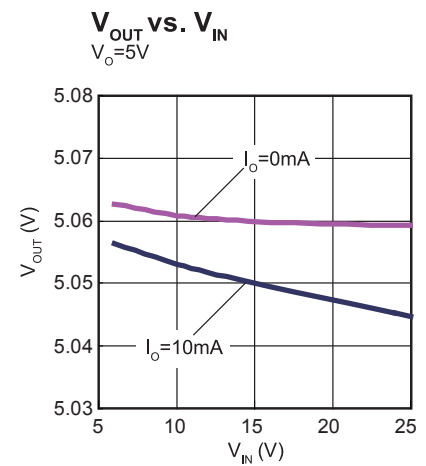
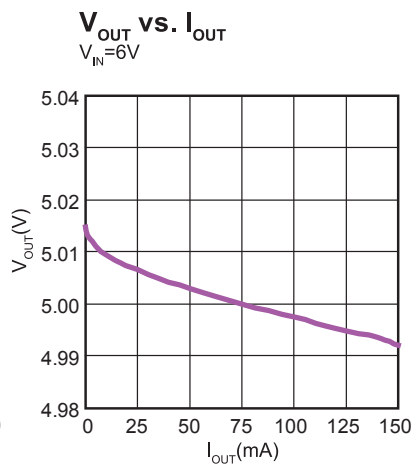
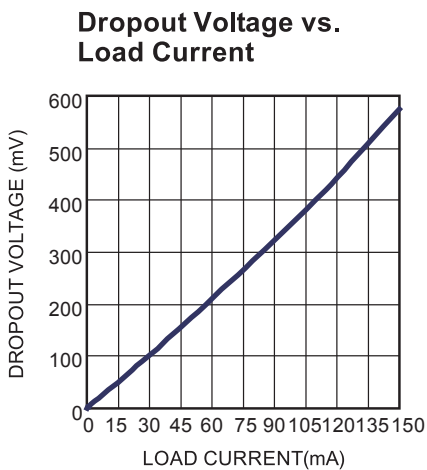
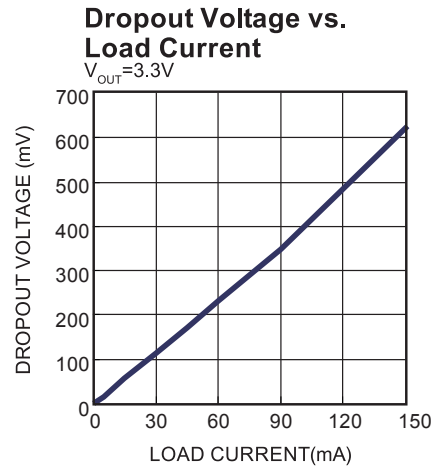
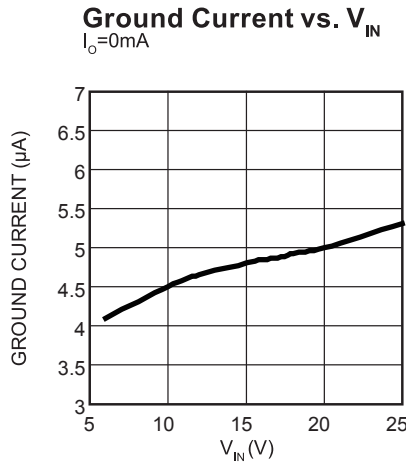
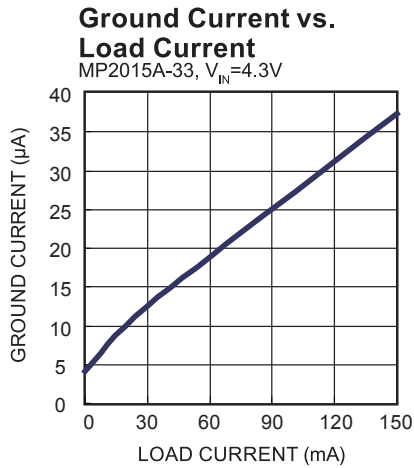

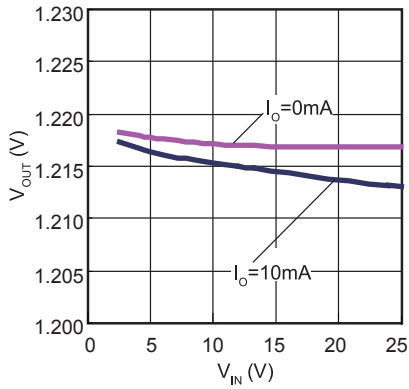
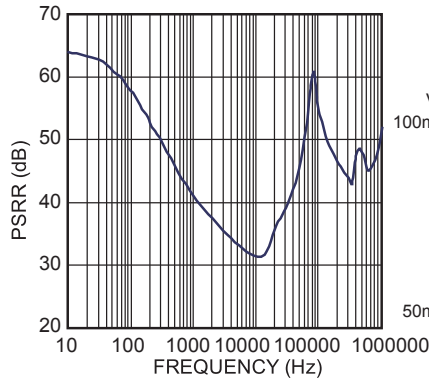
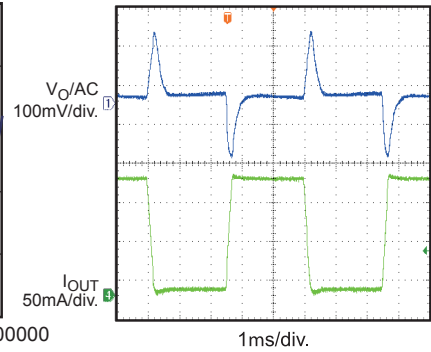
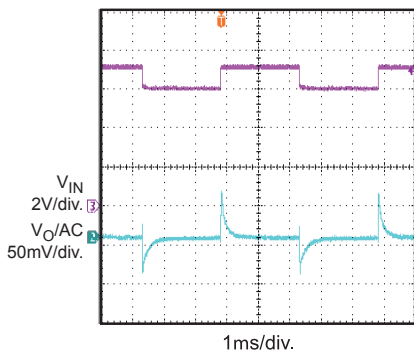
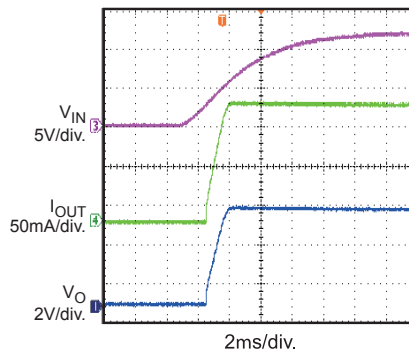
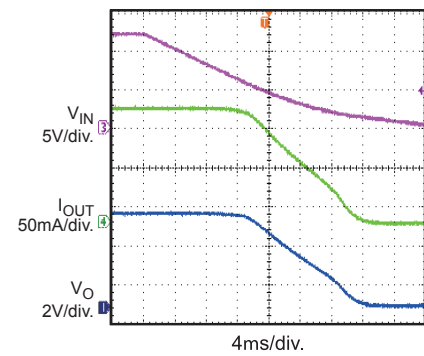
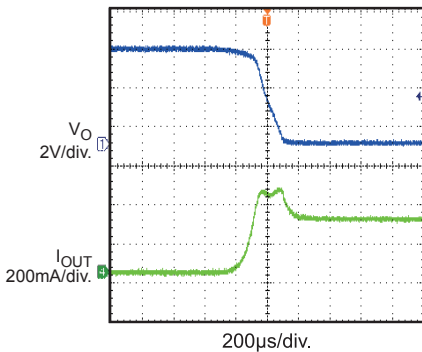
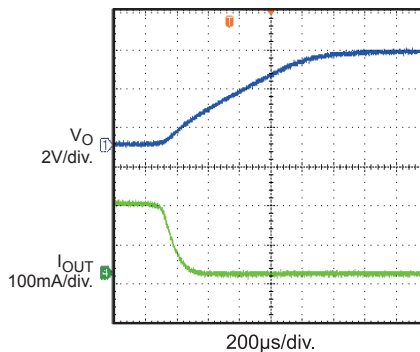
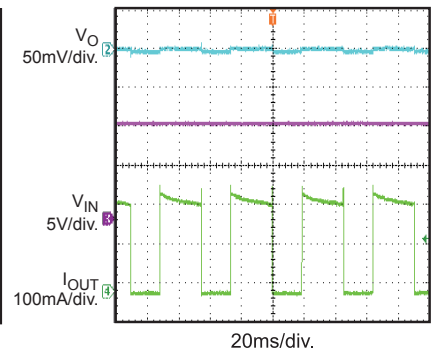
TYPICAL PERFORMANCE CHARACTERISTICS (continued)
 $C_{IN} = 1\mu F$, $C_{OUT} = 4.7\mu F$, $V_{OUT} = 5V$, $T_A = +25^\circ C$, unless otherwise noted
 V_{OUT} vs. V_{IN}
 $V_O = 1.215V$

PSRR vs. Frequency
 $V_{IN} = 6V$, $I_O = 10mA$, $C_{IN} = 100pF$

Load Transient
 $V_{IN} = 12V$, $I_{OUT} = 8mA-150mA$

Line Transient
 $V_{IN} = 6V-7V$, $I_{OUT} = 150mA$

Startup Through V_{IN}
 $V_{IN} = 12V$, $I_{OUT} = 150mA$

Shutdown Through V_{IN}
 $V_{IN} = 12V$, $I_{OUT} = 150mA$

Short Circuit Entry
 $V_{IN} = 12V$, $I_{OUT} = 0mA$ to short circuit

Short Circuit Recovery
 $V_{IN} = 12V$, short circuit to $I_{OUT} = 0mA$

Short Circuit Steady State
 $V_{IN} = 12V$

PIN FUNCTIONS

Pin #			Name	Description
QFN6 (2x2mm)	QFN8 (3x3mm)	TSOT23-4		
1	1	2	IN	Input Voltage. Connect a 2.5V to 24V supply to this pin.
2	2		EN	A logic low on this pin will shut down the IC, a logic high will start it up. Connect this pin to IN for automatic start up.
3, exposed pad	4, exposed pad	1	GND	Ground (the exposed pad and GND pin must be connected to the same ground plane)
4	5	4	FB	Feedback Input Pin, regulated to 1.215V nominally. Connected to an external resistive divider between OUT and GND to set output voltage. For fixed output version, this pin can be just float.
6	8	3	OUT	Regulated Output Voltage, only low-value ceramic capacitor ($\geq 0.47\mu\text{F}$) on output is required for stability.
5	3, 6, 7		NC	No Connection. May be left open or tied to Ground for improved thermal performance.

OPERATION

The MP2015A is a linear regulator that supplies power to systems with high voltage batteries. It includes a wide 2.5V to 24V input range, low dropout voltage and low quiescent supply current.

The MP2015A provides wide variety of fixed output voltage option: 1.8V, 1.9V, 2.3V, 2.5V, 3.0V, 3.3V, 3.45V, 5.0V; and also provides the output adjustable option (from 1.215V to 15V).

The output adjustable version has an output that is adjustable from 1.215V to 15V with a simple resistor divider. It uses external feedback, allowing the user to set the output voltage with an external resistor divider. The typical FB pin voltage is 1.215V.

The regulator output current is internally limited and the device is protected against over-load and over-temperature conditions.

The peak output current is limited to around 270mA, which exceeds the 150mA recommended continuous output current.

When the junction temperature is too high, the thermal sensor sends a signal to the control logic that will shutdown the IC. The IC will restart when the temperature has sufficiently cooled.

The maximum power output current is a function of the package's maximum power dissipation for a given temperature.

The maximum power dissipation is dependent on the thermal resistance of the case and the circuit board, the temperature difference between the die junction and the ambient air, and the rate of air flow. The GND pin and Exposed Pad must be connected to the ground plane for proper dissipation.

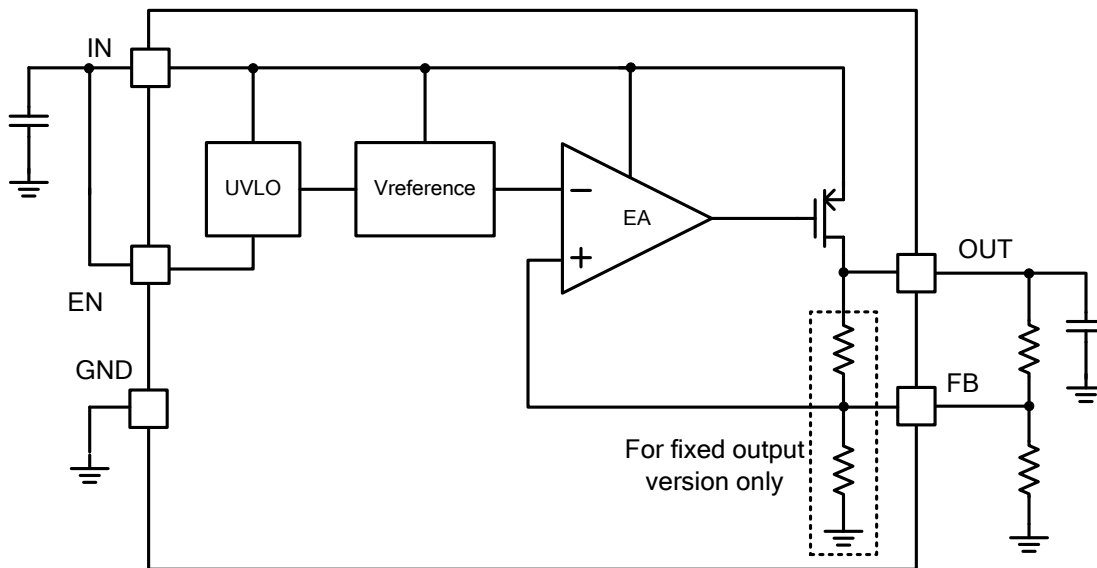

Figure 1: Functional Block Diagram

APPLICATION INFORMATION

COMPONENT SELECTION

Setting the Output Voltage

For adjustable output version. Set the output voltage of the MP2015A by using a resistor divider as shown:

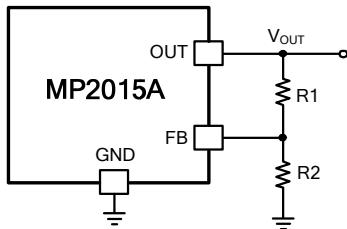

Figure 2: FB Resistor Divider to Set V_{OUT}

Choose $R2=1M\Omega$ to maintain a $1.215\mu A$ minimum load. Calculate the value for $R1$ using the following equation:

$$R1 = R2 \times \left(\frac{V_{OUT}}{1.215V} - 1 \right) \quad (1)$$

The above equation is only valid on adjustable output version. For fixed output version, V_{OUT} also can be adjusted by adding external resistor divider. Just note to take internal FB resistor divider into consideration when choose external divider. Choose a small resistance to mask internal feedback resistor network. The equation (1) still work but require the sum of $R1$ and $R2$ is less than $100k\Omega$.

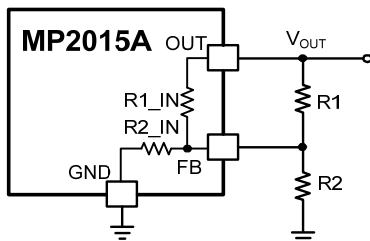

Figure 3: FB Divider of Fixed Output Version

The internal FB resistor dividers for different fixed output versions please see below table.

Table 1: Internal FB Resistor Divider

Fixed Output Voltage	R1_IN	R2_IN
3.3V	1.72M Ω	1M Ω

Input Capacitor

For proper operation, place a ceramic capacitor ($C1$) between $1\mu F$ and $10\mu F$ of dielectric type X5R or X7R between the input pin and ground. Larger values in this range will help to improve line transient response.

Output Capacitor

For stable operation, use a ceramic capacitor ($C2$) of type X5R or X7R between $1\mu F$ and $10\mu F$. Larger values in this range will help to improve load transient response and reduce noise. Output capacitors of other dielectric types may be used, but are not recommended as their capacitance can deviate greatly from their rated value over temperature.

To improve load transient response, add a small ceramic (X5R, X7R or Y5V dielectric) $22nF$ feed forward capacitor in parallel with $R1$. The feed forward capacitor is not required for stable operation.

Output Noise

The MP2015A will exhibit noise on the output during normal operation. This noise is negligible for most applications. However, in applications that include analog-to-digital converters (ADCs) of more than 12 bits, one needs to consider the ADC's power supply rejection specifications. The feed forward capacitor across $R1$ will significantly reduce the output noise.

External Reverse Voltage Protection

In some situations, e.g. a backup battery is connected as MP2015A load, the output voltage may be held up while the input is either pulled to ground, pulled to some intermediate voltage or is floating. Thus, the output voltage is higher than input voltage. Since the MP2015A PMOS pass element has a body diode, a current will conduct from the output to input and is not internally limited. It's possible that the IC will be damaged by this unlimited reverse current. To avoid this, it's recommended to place an external diode at input like below.

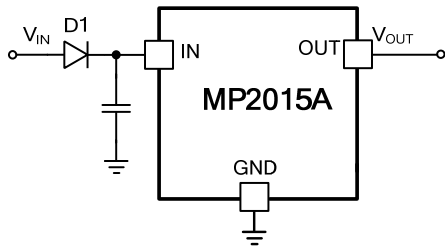

PCB layout guide

PCB layout is very important to achieve good regulation, ripple rejection, transient response and thermal performance. It is highly recommended to duplicate EVB layout for optimum performance.

If change is necessary, please follow these guidelines and take figure 4 for reference.

- 1) Input and output bypass ceramic capacitors are suggested to be put close to the IN Pin and OUT Pin respectively.
- 2) Ensure all feedback connections are short and direct. Place the feedback resistors and compensation components as close to the chip as possible.
- 3) Connect IN, OUT and especially GND respectively to a large copper area to cool the chip to improve thermal performance and long-term reliability.

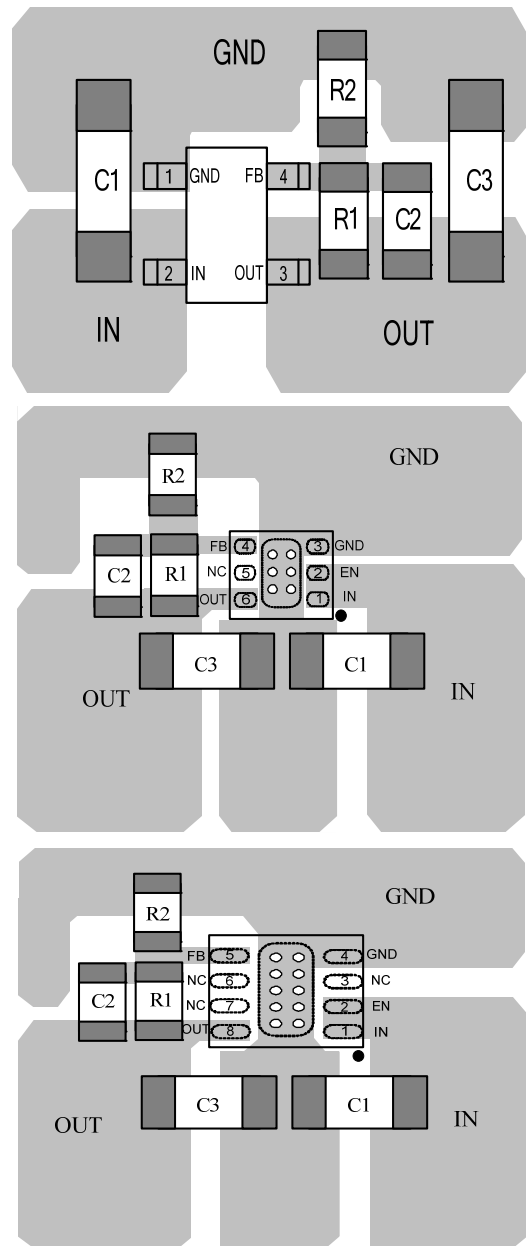
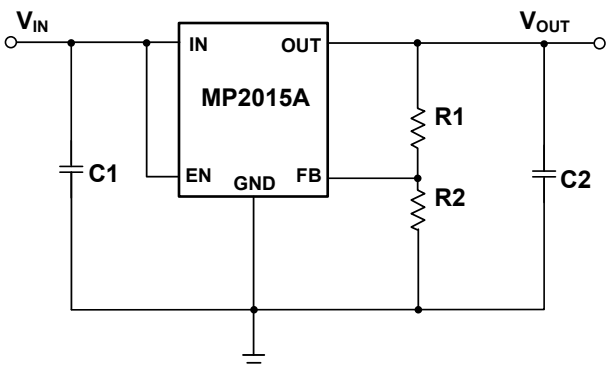
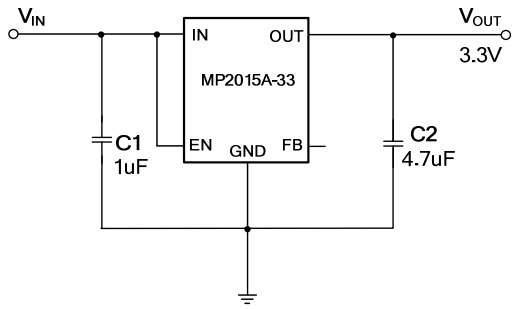

Figure 4: PCB Layout (Top Layer)

Design Example

Below is a design example following the application guidelines for $V_{OUT}=3.3V$.

**Figure 5: Design Example**

TYPICAL APPLICATION CIRCUITS

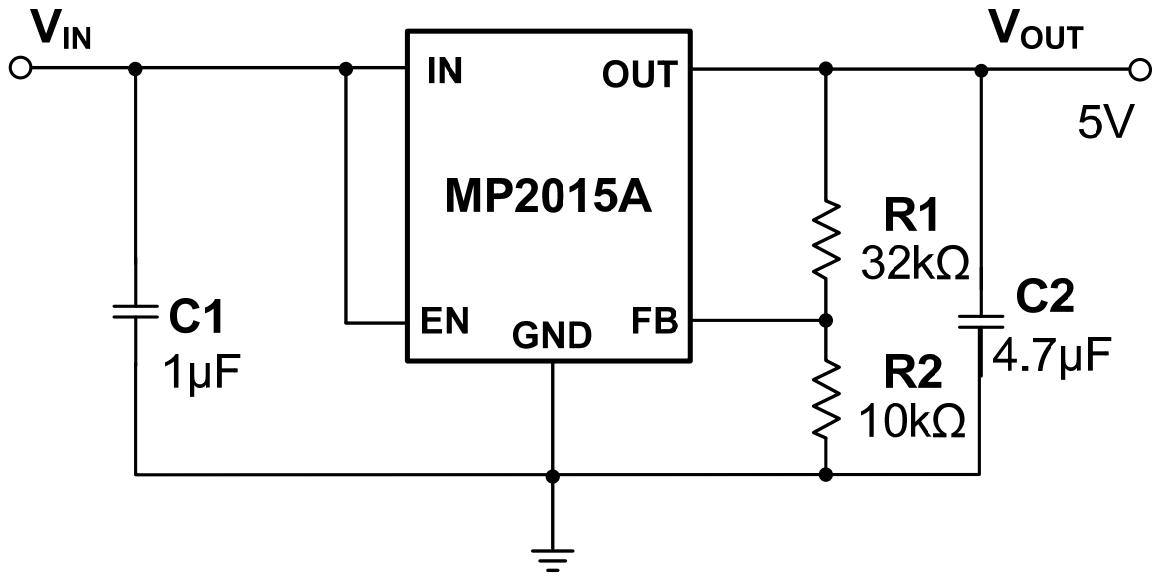
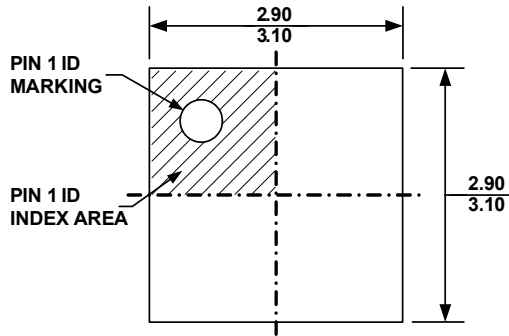
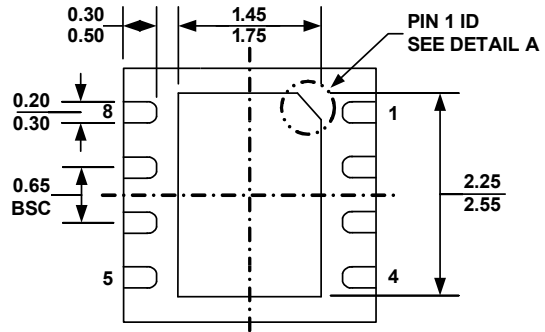
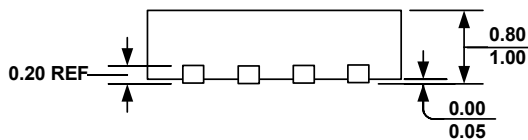
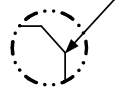
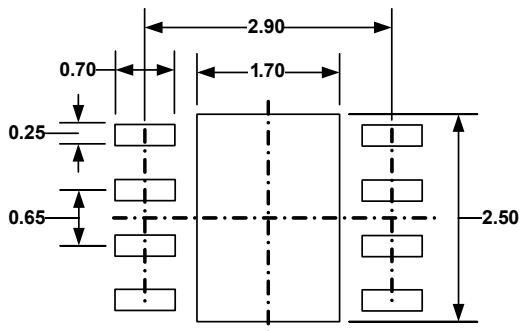
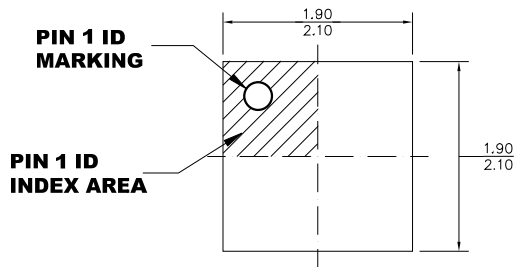
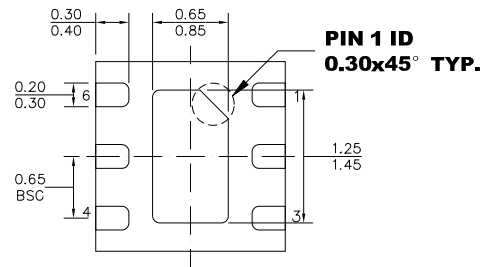
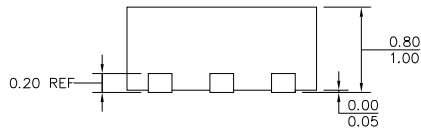
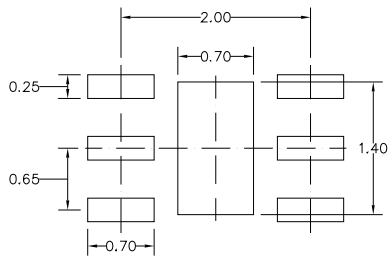

Figure 6: 5V Output Typical Application Circuit

PACKAGE INFORMATION
QFN-8 (3mmx3mm)

TOP VIEW

BOTTOM VIEW

SIDE VIEW
**PIN 1 ID OPTION A
0.30x45° TYP.**

**PIN 1 ID OPTION B
R0.20 TYP.**

DETAIL A

RECOMMENDED LAND PATTERN
NOTE:

- 1) ALL DIMENSIONS ARE IN MILLIMETERS
- 2) EXPOSED PADDLE SIZE DOES NOT INCLUDE MOLD FLASH
- 3) LEAD COPLANARITY SHALL BE 0.10 MILLIMETER MAX
- 4) JEDEC REFERENCE IS MO-229, VARIATION VEEC-2.
- 5) DRAWING IS NOT TO SCALE

QFN-6 (2mmx2mm)

TOP VIEW

BOTTOM VIEW

SIDE VIEW

RECOMMENDED LAND PATTERN
NOTE:

- 1) ALL DIMENSIONS ARE IN MILLIMETERS.
- 2) EXPOSED PADDLE SIZE DOES NOT INCLUDE MOLD FLASH.
- 3) LEAD COPLANARITY SHALL BE 0.08 MILLIMETERS MAX.
- 4) JEDEC REFERENCE IS MO-220.
- 5) DRAWING IS NOT TO SCALE.