

### DESCRIPTION

The MP2152 is a monolithic, step-down, switch-mode converter with built-in, internal power MOSFETs. The MP2152 achieves 2A of continuous output current from a 2.5V to 5.5V input voltage with excellent load and line regulation. The output voltage can be regulated as low as 0.6V.

The constant-on-time (COT) control scheme provides fast transient response and eases loop stabilization. Fault protections include cycle-by-cycle current limiting and thermal shutdown.

The MP2152 is ideal for a wide range of applications including high performance DSPs, wireless power, portable and mobile devices, and other low-power systems.

The MP2152 requires a minimal number of readily available, standard, external components and is available in ultra-small SOT563 or 1.2mmx1.6mm UTQFN packages.

### FEATURES

- Low I<sub>Q</sub>: 25 $\mu$ A
- 1.1MHz Switching Frequency
- EN for Power Sequencing
- 1% FB Accuracy
- Wide 2.5V to 5.5V Operating Input Range
- Output Adjustable from 0.6V
- Up to 2A Output Current
- 75m $\Omega$  and 45m $\Omega$  Internal Power MOSFET Switches
- 100% Duty On
- Output Discharge
- V<sub>OUT</sub> Over-Voltage Protection (OVP)
- Short-Circuit Protection (SCP) with Hiccup Mode
- Power Good Only for Fixed Output Version
- Available in SOT563 or UTQFN (1.2mmx1.6mm) Packages

### APPLICATIONS

- Wireless/Networking Cards
- Portable Instruments
- Battery-Powered Devices
- Low-Voltage I/O System Power
- Multi-Function Printers
- Solid-State Drives

All MPS parts are lead-free, halogen-free, and adhere to the RoHS directive. For MPS green status, please visit the MPS website under Quality Assurance. "MPS" and "The Future of Analog IC Technology" are registered trademarks of Monolithic Power Systems, Inc.

### TYPICAL APPLICATION

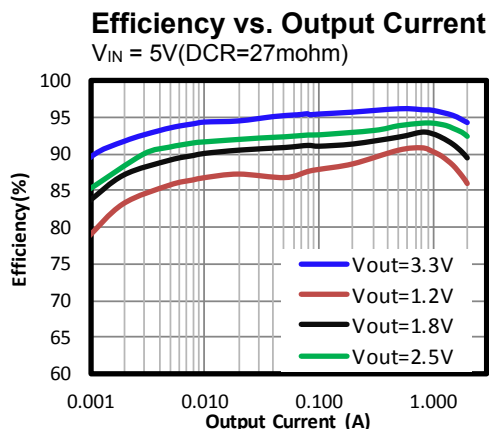
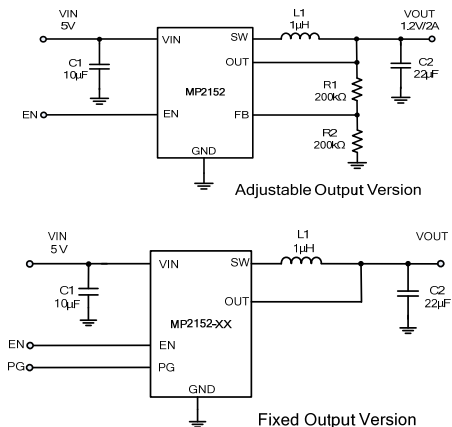

### ORDERING INFORMATION

| Part Number* | Package | Top Marking | V <sub>OUT</sub> Range |
|--------------|---------|-------------|------------------------|
| MP2152GTF    | SOT563  | See Below   | Adjustable             |
| MP2152GTF-12 |         |             | Fixed 1.2V             |
| MP2152GTF-15 |         |             | Fixed 1.5V             |
| MP2152GTF-18 |         |             | Fixed 1.8V             |
| MP2152GTF-25 |         |             | Fixed 2.5V             |
| MP2152GTF-33 |         |             | Fixed 3.3V             |

\* For Tape & Reel, add suffix –Z (e.g. MP2152GTF–Z)

#### TOP MARKING (MP2152GTF)

**AYRY**

**LLL**

AYR: Product code of MP2152GTF  
Y: Year code  
LLL: Lot number

#### TOP MARKING (MP2152GTF-12)

**BBJY**

**LLL**

BBJ: Product code of MP2152GTF-12  
Y: Year code  
LLL: Lot number

#### TOP MARKING (MP2152GTF-15)

**BBKY**

**LLL**

BBK: Product code of MP2152GTF-15  
Y: Year code  
LLL: Lot number

#### TOP MARKING (MP2152GTF-18)

**BBLY**

**LLL**

BBL: Product code of MP2152GTF-18  
Y: Year code  
LLL: Lot number

#### TOP MARKING (MP2152GTF-25)

**BBMY**

**LLL**

BBM: Product code of MP2152GTF-25  
Y: Year code  
LLL: Lot number

#### TOP MARKING (MP2152GTF-33)

**BBNY**

**LLL**

BBN: Product code of MP2152GTF-33  
Y: Year code  
LLL: Lot number

### PACKAGE REFERENCE

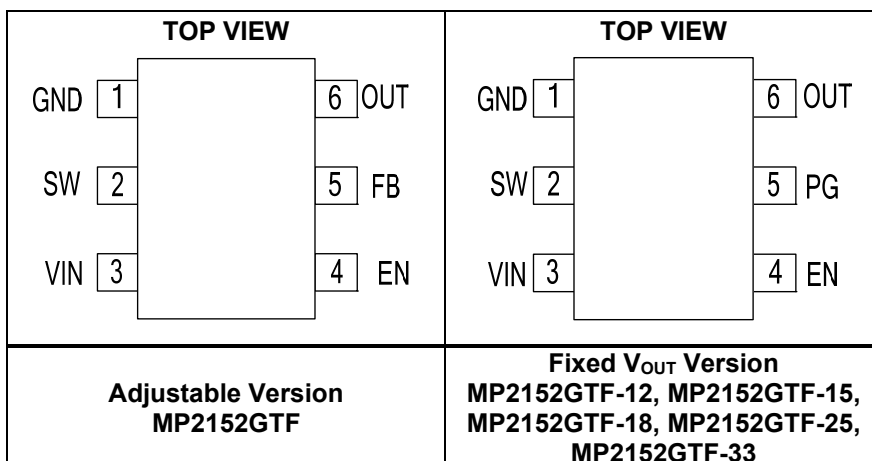

**ORDERING INFORMATION (continued)**

| Part Number*  | Package             | Top Marking | V <sub>OUT</sub> Range |
|---------------|---------------------|-------------|------------------------|
| MP2152GQFU    | UTQFN (1.2mmx1.6mm) | See Below   | Adjustable             |
| MP2152GQFU-12 |                     |             | Fixed 1.2V             |
| MP2152GQFU-15 |                     |             | Fixed 1.5V             |
| MP2152GQFU-18 |                     |             | Fixed 1.8V             |
| MP2152GQFU-25 |                     |             | Fixed 2.5V             |
| MP2152GQFU-33 |                     |             | Fixed 3.3V             |

\* For Tape & Reel, add suffix -Z (e.g. MP2152GQFU-Z)

**TOP MARKING (MP2152GQFU)**

FT  
LL

FT: Product code of MP2152GQFU  
LL: Lot number

**TOP MARKING (MP2152GQFU-12)**

GJ  
LL

GJ: Product code of MP2152GQFU-12  
LL: Lot number

**TOP MARKING (MP2152GQFU-15)**

GK  
LL

GK: Product code of MP2152GQFU-15  
LL: Lot number

**TOP MARKING (MP2152GQFU-18)**

GL  
LL

GL: Product code of MP2152GQFU-18  
LL: Lot number

**TOP MARKING (MP2152GQFU-25)**

GM  
LL

GM: Product code of MP2152GQFU-25  
LL: Lot number

**TOP MARKING (MP2152GQFU-33)**

GN  
LL

GN: Product code of MP2152GQFU-33  
LL: Lot number

**PACKAGE REFERENCE**

| TOP VIEW                         |   | TOP VIEW  |   |
|----------------------------------|---|---|---|
| GND                              | 1 | GND   | 1 |
| SW                               | 2 | SW  | 2 |
| VIN                              | 3 | VIN   | 3 |
|                                  | 4 |   | 4 |
| OUT                              | 6 | OUT   | 6 |
| FB                               | 5 | PG  | 5 |
| EN                               | 4 | EN  | 4 |
| Adjustable Version<br>MP2152GQFU |   | Fixed V <sub>OUT</sub> Version<br>MP2152GQFU-12, MP2152GQFU-15,<br>MP2152GQFU-18, MP2152GQFU-25,<br>MP2152GQFU-33 |   |

**ABSOLUTE MAXIMUM RATINGS** <sup>(1)</sup>

|   |  |
|---|--|
| Supply voltage (V <sub>IN</sub> ) .....               | 6.5V   |
| V <sub>SW</sub> .....                                 | -0.3V (-5V for <10ns) to<br>6.5V (10V for <10ns) |
| All other pins .....                                  | -0.3V to 6.5 V                                   |
| Junction temperature .....                            | 150°C  |
| Lead temperature.....                                 | 260°C  |
| Continuous power dissipation (T <sub>A</sub> = +25°C) |  |
| SOT563.....   | 1.5W <sup>(2)</sup> <sup>(4)</sup>               |
| QFN.....  | 2W <sup>(2)</sup> <sup>(5)</sup>                 |
| Storage temperature .....                             | -65°C to +150°C                                  |

**Recommended Operating Conditions** <sup>(3)</sup>

|  |                 |
|--|-----------------|
| Supply voltage (V <sub>IN</sub> ) .....        | 2.5V to 5.5V    |
| Operating junction temp. (T <sub>J</sub> ).... | -40°C to +125°C |

| <i>Thermal Resistance</i>           | $\theta_{JA}$ | $\theta_{JC}$ |
|-------------------------------------|---------------|---------------|
| <b>SOT563</b>                       |               |               |
| EV2152-TF-00A <sup>(4)</sup> .....  | 80 .....      | 50 ... °C/W   |
| JESD51-7 <sup>(6)</sup> .....       | 130 .....     | 60 ... °C/W   |
| <b>QFN (1.2mmx1.6mm)</b>            |               |               |
| EV2152-QFU-00A <sup>(5)</sup> ..... | 65 .....      | 30 ... °C/W   |
| JESD51-7 <sup>(6)</sup> .....       | 173 .....     | 127 .. °C/W   |

**NOTES:**

- 1) Exceeding these ratings may damage the device.
- 2) The maximum allowable power dissipation is a function of the maximum junction temperature T<sub>J</sub> (MAX), the junction-to-ambient thermal resistance  $\theta_{JA}$ , and the ambient temperature T<sub>A</sub>. The maximum allowable continuous power dissipation at any ambient temperature is calculated by P<sub>D</sub> (MAX) = (T<sub>J</sub> (MAX)-T<sub>A</sub>)/ $\theta_{JA}$ . Exceeding the maximum allowable power dissipation produces an excessive die temperature, causing the regulator to go into thermal shutdown. Internal thermal shutdown circuitry protects the device from permanent damage.
- 3) The device is not guaranteed to function outside of its operating conditions.
- 4) Measured on EV2152-TF-00A demo board, 2-layer PCB.
- 5) Measured on EV2152-QFU-00A demo board, 2-layer PCB.
- 6) Measured on JESD51-7, 4-layer PCB.  
note 6) The value of  $\theta_{JA}$  given in this table is only valid for comparison with other packages and cannot be used for design purposes. These values are calculated in accordance with JESD51-7, and simulated on a specified JEDEC board. They do not represent the performance obtained in an actual application.

## ELECTRICAL CHARACTERISTICS

V<sub>IN</sub> = 3.6V, T<sub>J</sub> = -40°C to +125°C <sup>(7)</sup>, typical value is tested at T<sub>J</sub> = +25°C. The limit over temperature is guaranteed by characterization, unless otherwise noted.

| Parameter                                  | Symbol               | Condition  | Min  | Typ  | Max  | Units      |
|--|----------------------|--|------|------|------|------------|
| V <sub>IN</sub> range                      |                      |  | 2.5  |      | 5.5  | V          |
| Under-voltage lockout threshold rising     |                      |  |      | 2.3  | 2.45 | V          |
| Under-voltage lockout threshold hysteresis |                      |  |      | 200  |      | mV         |
| Feedback voltage                           | V <sub>FB</sub>      | T <sub>J</sub> = 25°C  | 594  | 600  | 606  | mV         |
|  |                      | T <sub>J</sub> = -40°C to +125°C   | 591  | 600  | 609  |            |
| OUT voltage (MP2152XXX-12)                 | V <sub>O</sub>       | T <sub>J</sub> = 25°C  | 1188 | 1200 | 1212 | mV         |
|  |                      | T <sub>J</sub> = -40°C to +125°C   | 1182 | 1200 | 1218 | mV         |
| OUT voltage (MP2152XXX-15)                 | V <sub>O</sub>       | T <sub>J</sub> = 25°C  | 1485 | 1500 | 1515 | mV         |
|  |                      | T <sub>J</sub> = -40°C to +125°C   | 1478 | 1500 | 1522 | mV         |
| OUT voltage (MP2152XXX-18)                 | V <sub>O</sub>       | T <sub>J</sub> = 25°C  | 1782 | 1800 | 1818 | mV         |
|  |                      | T <sub>J</sub> = -40°C to +125°C   | 1773 | 1800 | 1827 | mV         |
| OUT voltage (MP2152XXX-25)                 | V <sub>O</sub>       | T <sub>J</sub> = 25°C  | 2475 | 2500 | 2525 | mV         |
|  |                      | T <sub>J</sub> = -40°C to +125°C   | 2463 | 2500 | 2537 | mV         |
| OUT voltage (MP2152XXX-33)                 | V <sub>O</sub>       | T <sub>J</sub> = 25°C  | 3267 | 3300 | 3333 | mV         |
|  |                      | T <sub>J</sub> = -40°C to +125°C   | 3251 | 3300 | 3349 | mV         |
| Feedback current                           | I <sub>FB</sub>      | V <sub>FB</sub> = 0.63V  |      | 50   | 100  | nA         |
| P-FET switch on resistance                 | R <sub>DSON_P</sub>  | V <sub>IN</sub> = 5V   |      | 75   |      | m $\Omega$ |
| N-FET switch on resistance                 | R <sub>DSON_N</sub>  | V <sub>IN</sub> = 5V   |      | 45   |      | m $\Omega$ |
| Switch leakage                             |                      | V <sub>EN</sub> = 0V, V <sub>IN</sub> = 6V,<br>V <sub>SW</sub> = 0V and 6V, T <sub>J</sub> = +25°C |      | 0    | 1    | $\mu$ A    |
| P-FET peak current limit                   |                      |  | 2.8  |      | 4    | A          |
| N-FET valley current limit                 |                      |  |      | 2.5  |      | A          |
| ZCD  |                      |  |      | 50   |      | mA         |
| On time                                    | T <sub>ON</sub>      | V <sub>IN</sub> = 5V, V <sub>OUT</sub> = 1.2V  | 180  | 220  | 260  | ns         |
|  |                      | V <sub>IN</sub> = 3.6V, V <sub>OUT</sub> = 1.2V  | 240  | 300  | 360  |            |
| Switching frequency                        | f <sub>s</sub>       | V <sub>OUT</sub> = 1.2V  |      | 1100 |      | kHz        |
| Minimum off time                           | T <sub>MIN-OFF</sub> |  |      | 100  |      | ns         |
| Minimum on time <sup>(8)</sup>             | T <sub>MIN-ON</sub>  |  |      | 60   |      | ns         |
| Soft-start time                            | T <sub>SS-ON</sub>   | V <sub>OUT</sub> rise from 10% to 90%  |      | 0.5  |      | ms         |
| Maximum duty cycle                         |                      |  | 100  |      |      | %          |
| Power good rising threshold UV             |                      | Fixed V <sub>OUT</sub> version, V <sub>OUT</sub> rising edge                                       |      | 90   |      | %          |
| Power good falling threshold UV            |                      | Fixed V <sub>OUT</sub> version, V <sub>OUT</sub> falling edge                                      |      | 85   |      | %          |
| Power good rising threshold OV             |                      | Fixed V <sub>OUT</sub> version, V <sub>OUT</sub> rising edge                                       |      | 115  |      | %          |
| Power good falling threshold OV            |                      | Fixed V <sub>OUT</sub> version, V <sub>OUT</sub> falling edge                                      |      | 105  |      | %          |

**ELECTRICAL CHARACTERISTICS (continued)**

V<sub>IN</sub> = 3.6V, T<sub>J</sub> = -40°C to +125°C <sup>(7)</sup>, typical value is tested at T<sub>J</sub> = +25°C. The limit over temperature is guaranteed by characterization, unless otherwise noted.

| Parameter   | Symbol   | Condition   | Min  | Typ  | Max  | Units           |
|---|----------|---|------|------|------|-----------------|
| Power good delay                                  | PGD      | Fixed V <sub>OUT</sub> version, PG rising/falling edge                                      |      | 150  |      | $\mu$ s         |
| Power good sink current capability                | VPG-L    | Fixed V <sub>OUT</sub> version, sink 1mA  |      |      | 0.4  | V               |
| Power good logic high voltage                     | VPG-H    | Fixed V <sub>OUT</sub> version, V <sub>IN</sub> = 5V, V <sub>OUT</sub> = fixed OUT          | 4.9  |      |      | V               |
| EN turn-on delay                                  |          | EN on to SW active  |      | 150  |      | $\mu$ s         |
| EN input logic low voltage                        |          |   |      |      | 0.4  | V               |
| EN input logic high voltage                       |          |   | 1.2  |      |      | V               |
| Output discharge resistor                         | RDIS     | V <sub>EN</sub> = 0V, V <sub>OUT</sub> = 1.2V   |      | 200  |      | $\Omega$        |
| EN input current                                  |          | V <sub>EN</sub> = 2V  |      | 1.2  |      | $\mu$ A         |
|   |          | V <sub>EN</sub> = 0V  |      | 0    |      | $\mu$ A         |
| Supply current (shutdown)                         |          | V <sub>EN</sub> = 0V, T <sub>J</sub> = +25°C  |      | 0    | 1    | $\mu$ A         |
| Supply current(quiescent) (MP2152XX, Adjustable)  |          | V <sub>EN</sub> = 2V, V <sub>FB</sub> = 0.63V, V <sub>IN</sub> = 5V, T <sub>J</sub> = +25°C |      | 25   | 30   | $\mu$ A         |
| Supply Current(Quiescent) (MP2152XX-XX, Fixed Vo) |          | V <sub>EN</sub> =2V, NO Switching, V <sub>IN</sub> =5V, T <sub>J</sub> = +25°C              |      | 30   | 35   | $\mu$ A         |
| Output over-voltage threshold                     | VOVP     |   | 110% | 115% | 120% | V <sub>FB</sub> |
| V <sub>OUT</sub> OVP hysteresis                   | VOVP_HYS |   |      | 10%  |      | V <sub>FB</sub> |
| OVP delay   |          |   |      | 12   |      | $\mu$ s         |
| Low-side current                                  |          | Current flow from SW to GND   |      | 1.5  |      | A               |
| Absolute V <sub>IN</sub> OVP                      |          | After V <sub>OUT</sub> OVP enables  |      | 6.1  |      | V               |
| Absolute V <sub>IN</sub> OVP hysteresis           |          |   |      | 400  |      | mV              |
| Thermal shutdown <sup>(8)</sup>                   |          |   |      | 160  |      | °C              |
| Thermal hysteresis <sup>(8)</sup>                 |          |   |      | 30   |      | °C              |

**NOTES:**

- 7) Guaranteed by over-temperature correlation, not tested in production.  
 8) Guaranteed by engineering sample characterization.

### TYPICAL CHARACTERISTICS

V<sub>IN</sub> = 3.6V, V<sub>OUT</sub> = 1.2V, L = 1 $\mu$ H, C<sub>OUT</sub> = 22 $\mu$ F, T<sub>A</sub> = +25°C, unless otherwise noted.

**Quiescent Current vs. Input Voltage**

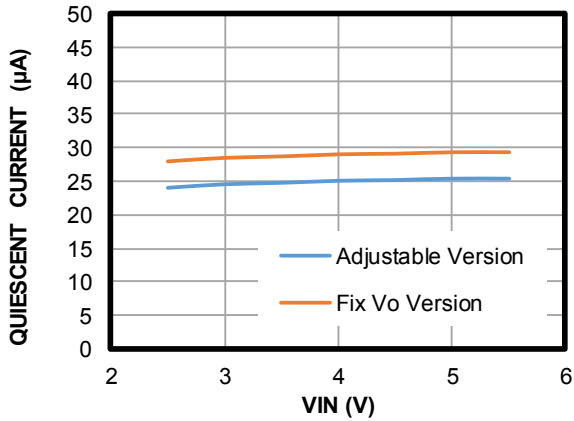

**Shutdown Current vs. Input Voltage**

V<sub>EN</sub> = 0V

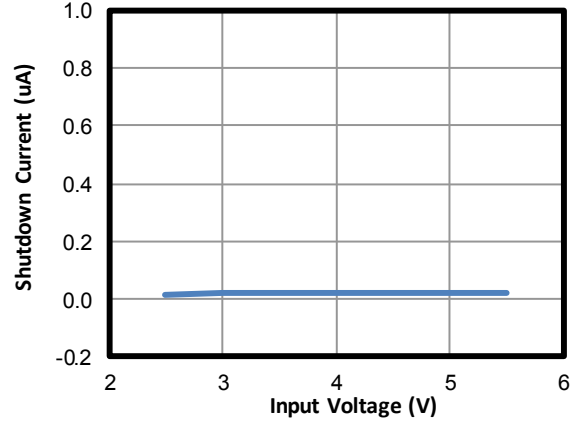

**Load Regulation**

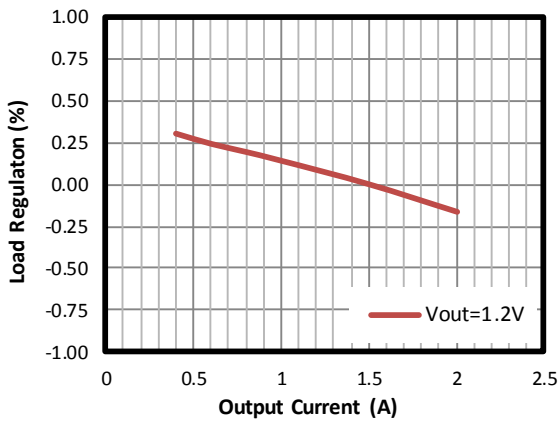

**Line Regulation**

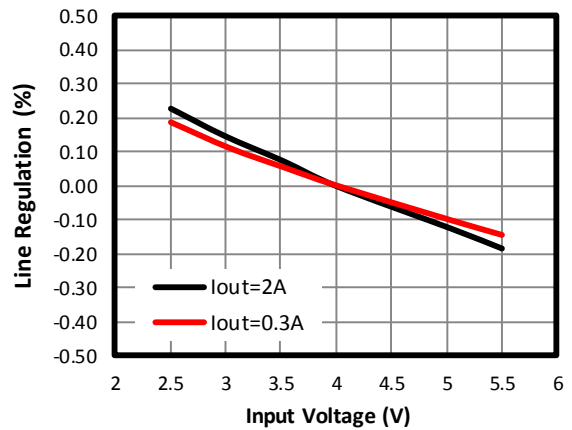

**Case Temperature Rising vs. Output Current**

V<sub>IN</sub> = 5V

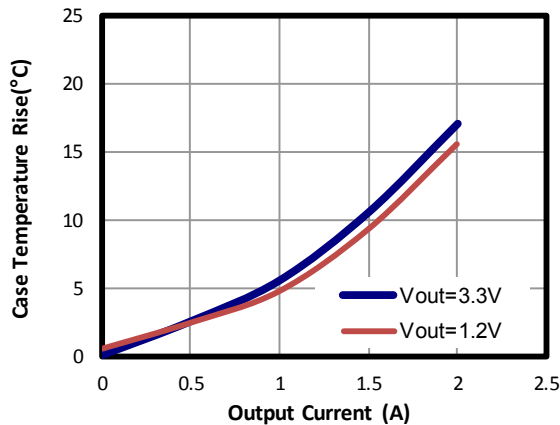

**Efficiency vs. Output Current**

V<sub>IN</sub> = 5V

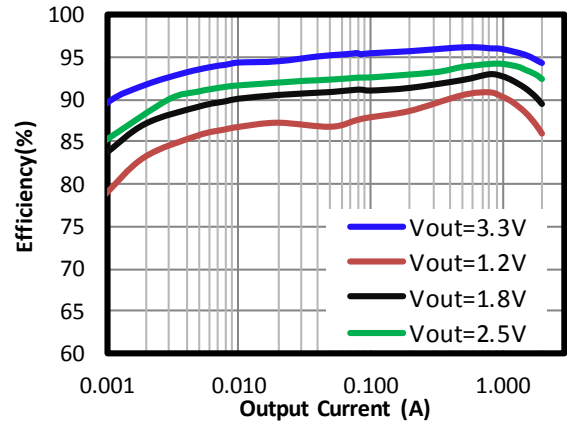

**TYPICAL CHARACTERISTICS** *(continued)*

V<sub>IN</sub> = 3.6V, V<sub>OUT</sub> = 1.2V, L = 1 $\mu$ H, C<sub>OUT</sub> = 22 $\mu$ F, T<sub>A</sub> = +25 $^{\circ}$ C, unless otherwise noted.

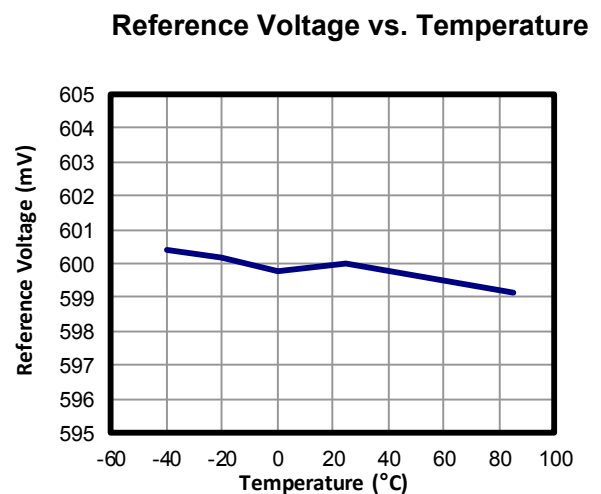
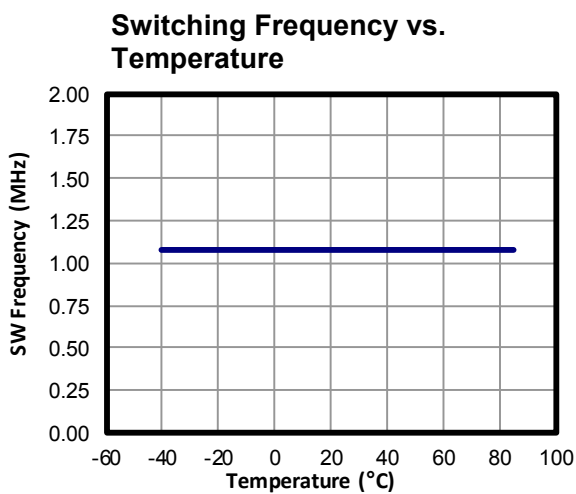
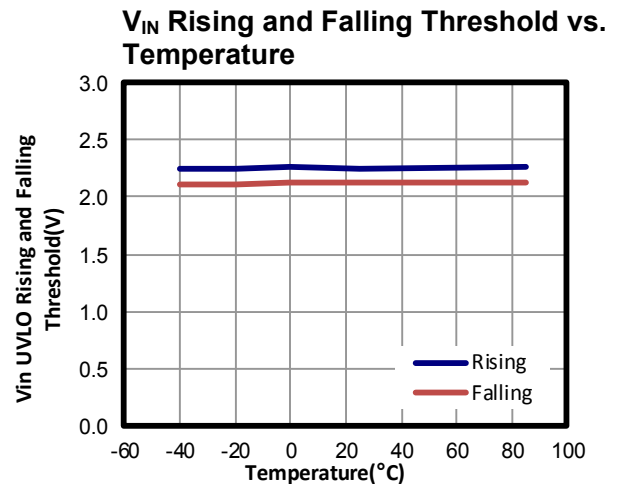
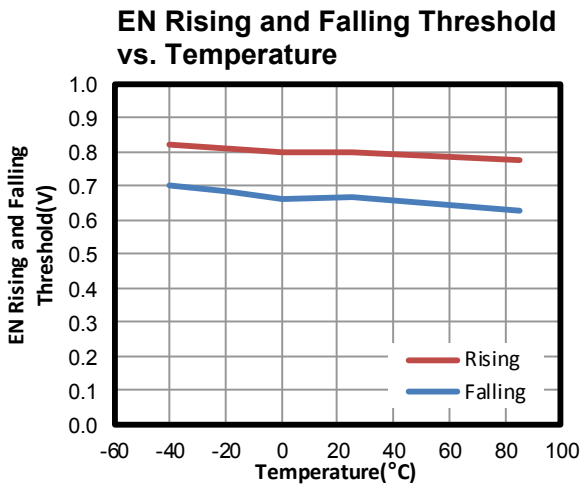
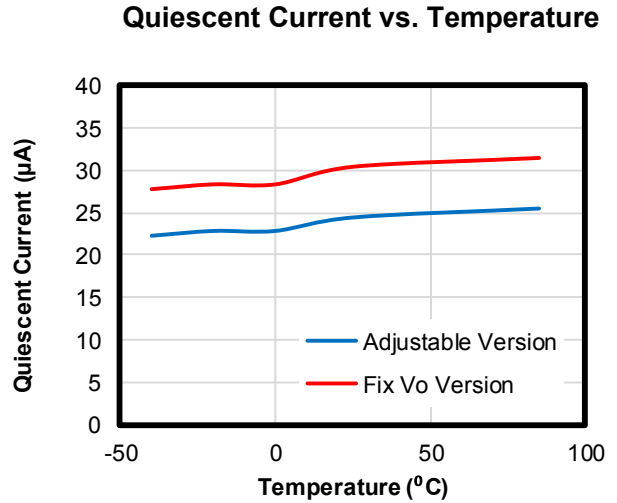
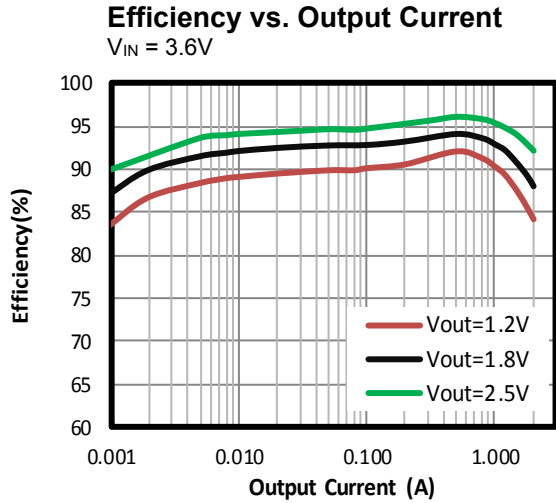

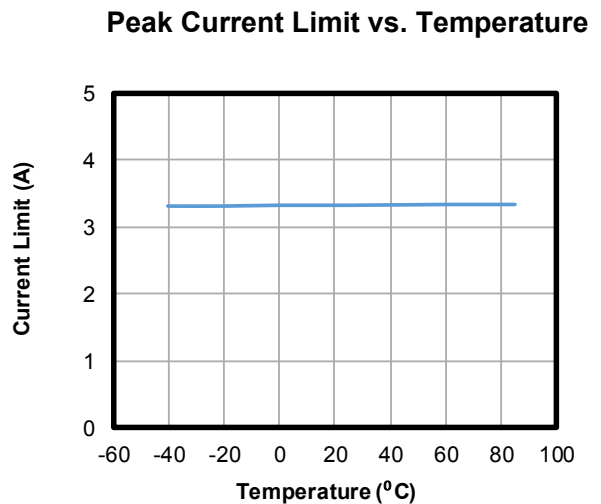
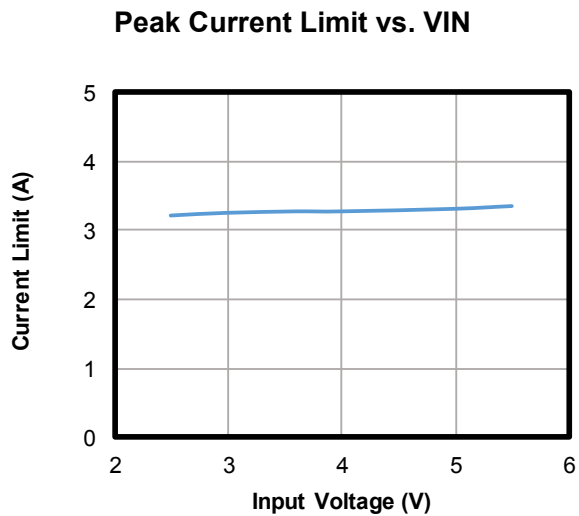
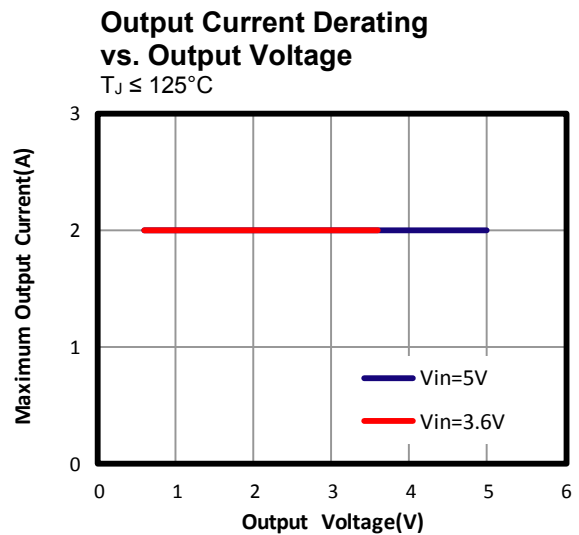
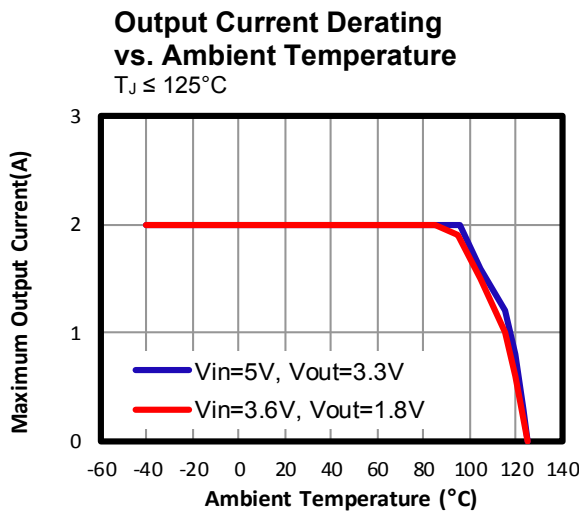
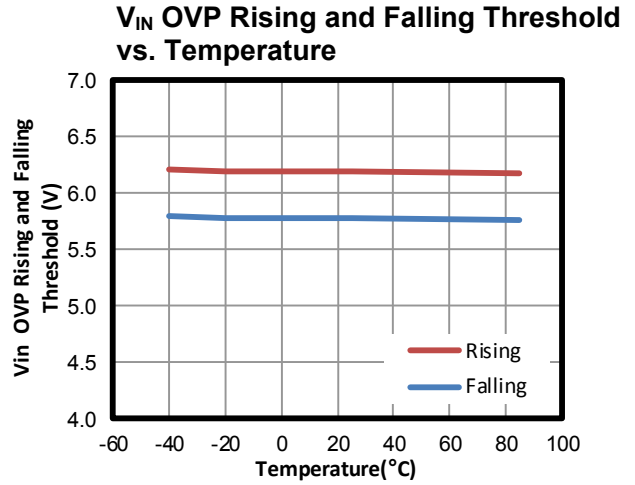
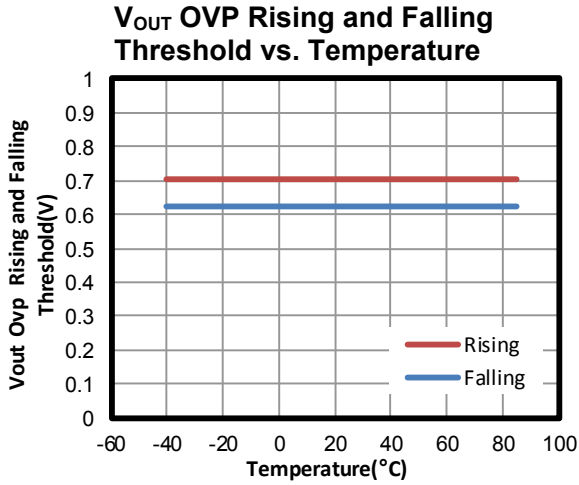

**TYPICAL CHARACTERISTICS (continued)**

 V<sub>IN</sub> = 3.6V, V<sub>OUT</sub> = 1.2V, L = 1 $\mu$ H, C<sub>OUT</sub> = 22 $\mu$ F, T<sub>A</sub> = +25°C, unless otherwise noted.

**TYPICAL PERFORMANCE CHARACTERISTICS**
**V<sub>IN</sub> = 5V, V<sub>OUT</sub> = 1.2V, L = 1 $\mu$ H, C<sub>OUT</sub> = 22 $\mu$ F, T<sub>A</sub> = +25°C, unless otherwise noted.**
**Steady State**

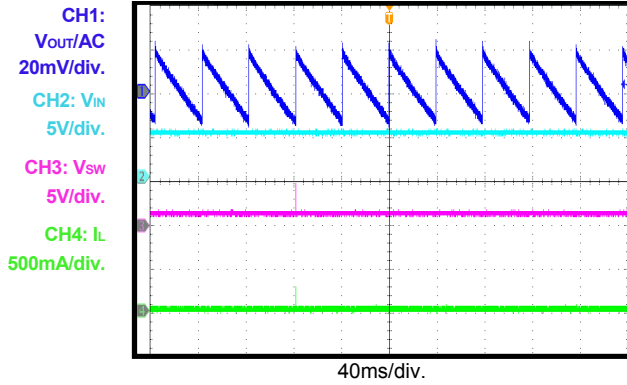
 I<sub>OUT</sub> = 0A

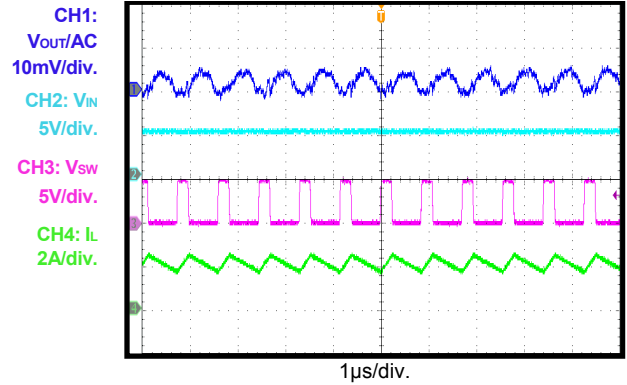
**Steady State**

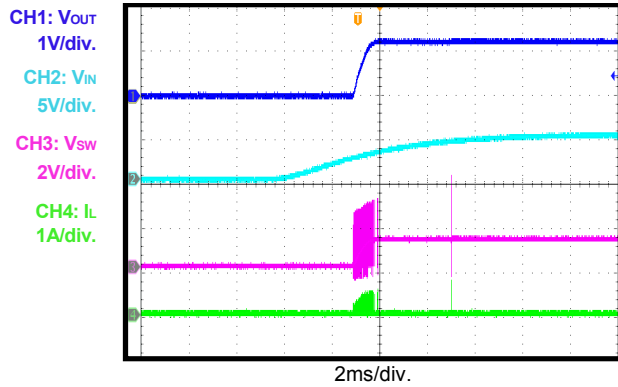
 I<sub>OUT</sub> = 2A

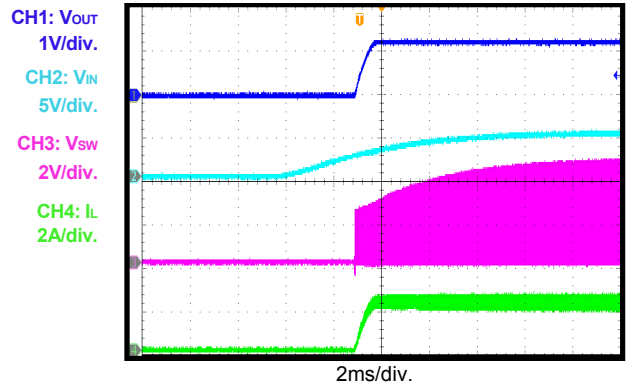
**V<sub>IN</sub> Power-Up**

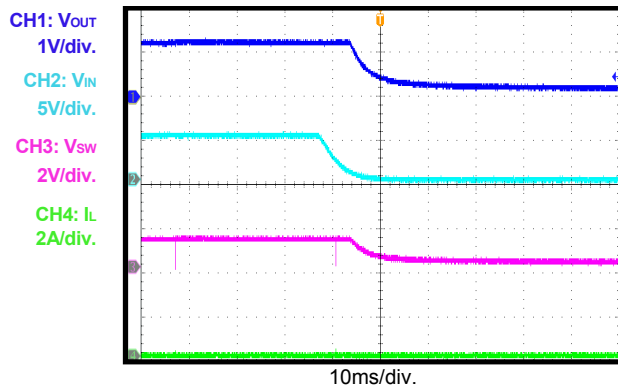
 I<sub>OUT</sub> = 0A

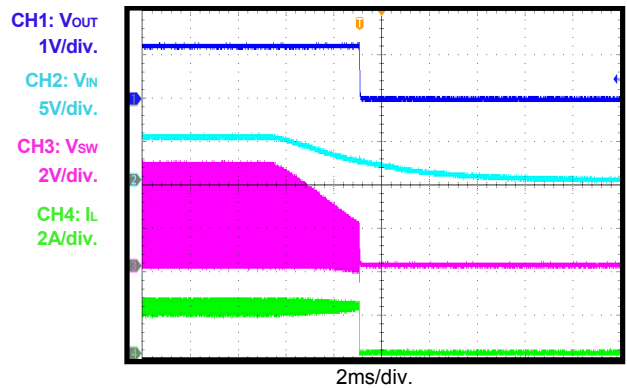
**V<sub>IN</sub> Power-Up**

 I<sub>OUT</sub> = 2A

**V<sub>IN</sub> Shutdown**

 I<sub>OUT</sub> = 0A

**V<sub>IN</sub> Shutdown**

 I<sub>OUT</sub> = 2A

**TYPICAL PERFORMANCE CHARACTERISTICS (continued)**

V<sub>IN</sub> = 5V, V<sub>OUT</sub> = 1.2V, L = 1 $\mu$ H, C<sub>OUT</sub> = 22 $\mu$ F, T<sub>A</sub> = +25°C, unless otherwise noted.

**EN Power-Up**

I<sub>OUT</sub> = 0A

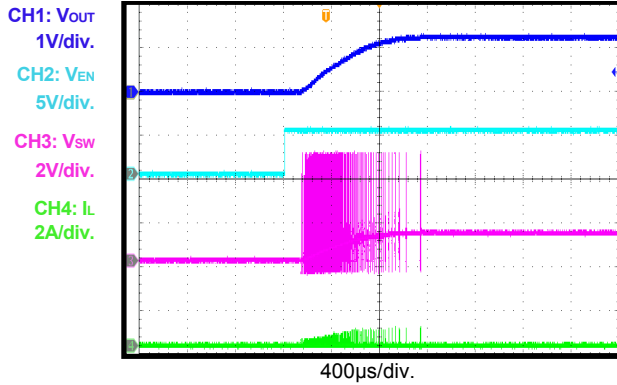

**EN Power-Up**

I<sub>OUT</sub> = 2A

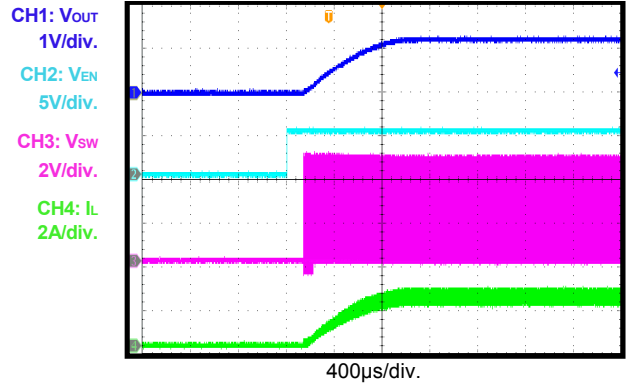

**EN Shutdown**

I<sub>OUT</sub> = 0A

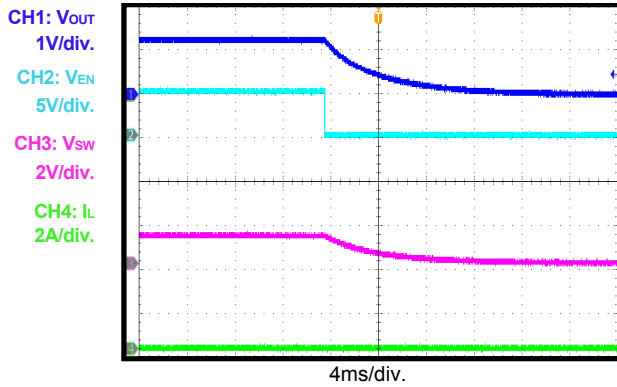

**EN Shutdown**

I<sub>OUT</sub> = 2A

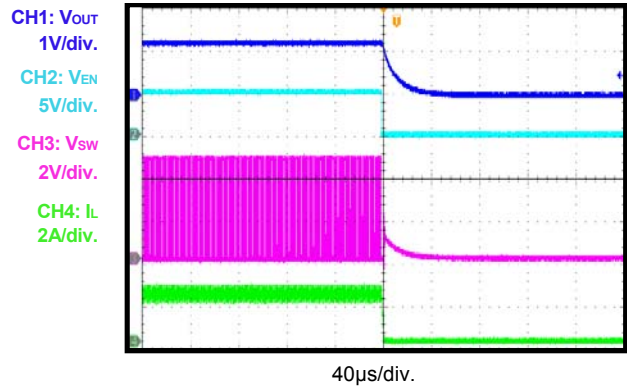

**Load Transient**

I<sub>OUT</sub> = 0 - 1A, 1A/ $\mu$ s

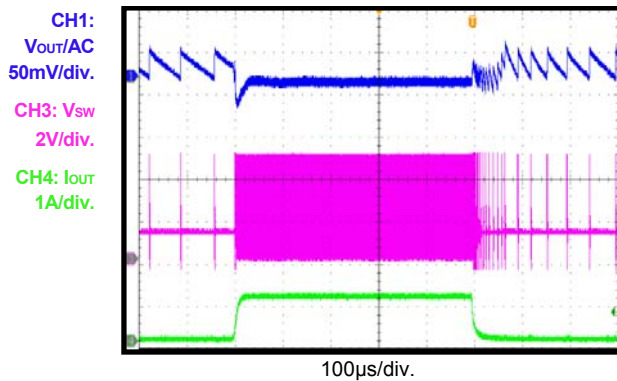

**Load Transient**

I<sub>OUT</sub> = 0.1 - 2A, 1A/ $\mu$ s

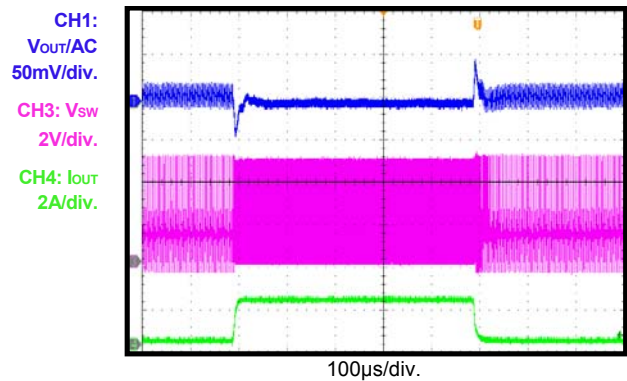

**TYPICAL PERFORMANCE CHARACTERISTICS (continued)**

V<sub>IN</sub> = 5V, V<sub>OUT</sub> = 1.2V, L = 1 $\mu$ H, C<sub>OUT</sub> = 22 $\mu$ F, T<sub>A</sub> = +25°C, unless otherwise noted.

**Short-Circuit Entry**

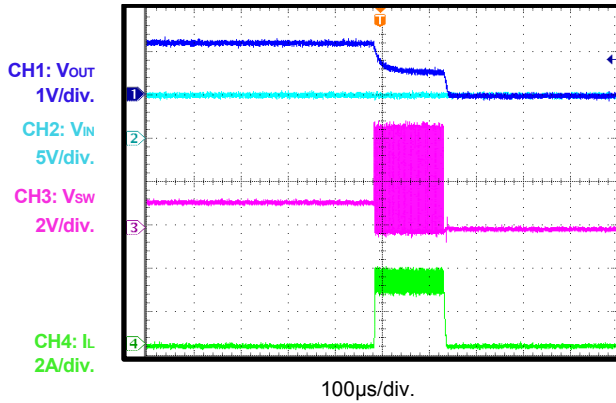

**Short-Circuit State**

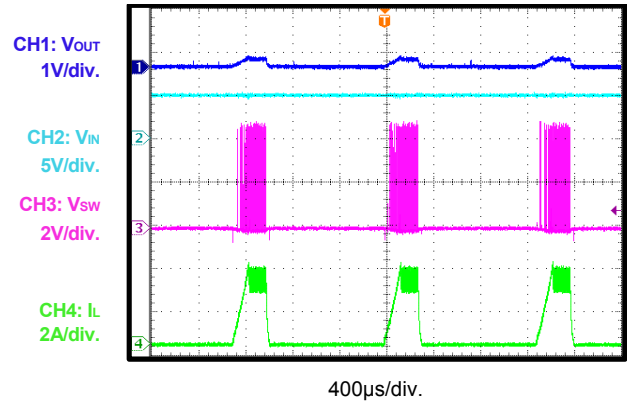

**Short-Circuit Recovery**

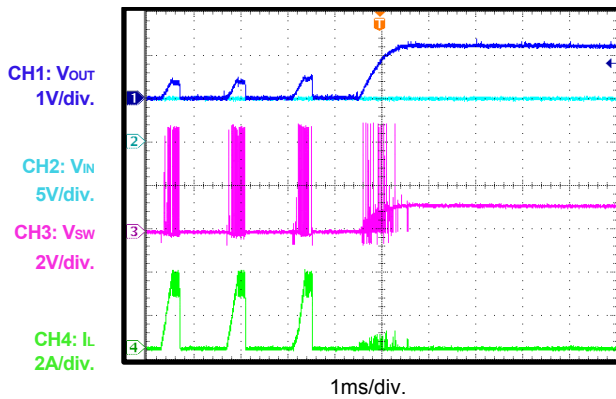

**PIN FUNCTIONS**

| Pin # | Name             |       | Description  |
|-------|------------------|-------|--|
|       | SOT563 and UTQFN |       |  |
|       | Adj              | Fixed |  |
| 1     | GND              | GND   | <b>Power ground.</b>   |
| 2     | SW               | SW    | <b>Output switching node.</b> SW is the drain of the internal high-side P-channel MOSFET. Connect the inductor to SW to complete the converter.  |
| 3     | VIN              | VIN   | <b>Supply voltage.</b> The MP2152 operates from a +2.5V to +5.5V unregulated input. A decoupling capacitor is needed to prevent large voltage spikes from appearing at the input.        |
| 4     | EN               | EN    | <b>On/off control.</b>   |
| 5     | FB               | -     | <b>Feedback.</b> An external resistor divider from the output to GND tapped to FB sets the output voltage.   |
|       | -                | PG    | <b>Power good indicator.</b> The output of PG is an open drain with an external pull-up resistor to VIN.   |
| 6     | OUT              | OUT   | <b>Output sense.</b> OUT is the voltage power rail and input sense for the output voltage. Connect the load to OUT. An output capacitor is needed to decrease the output voltage ripple. |

### BLOCK DIAGRAM

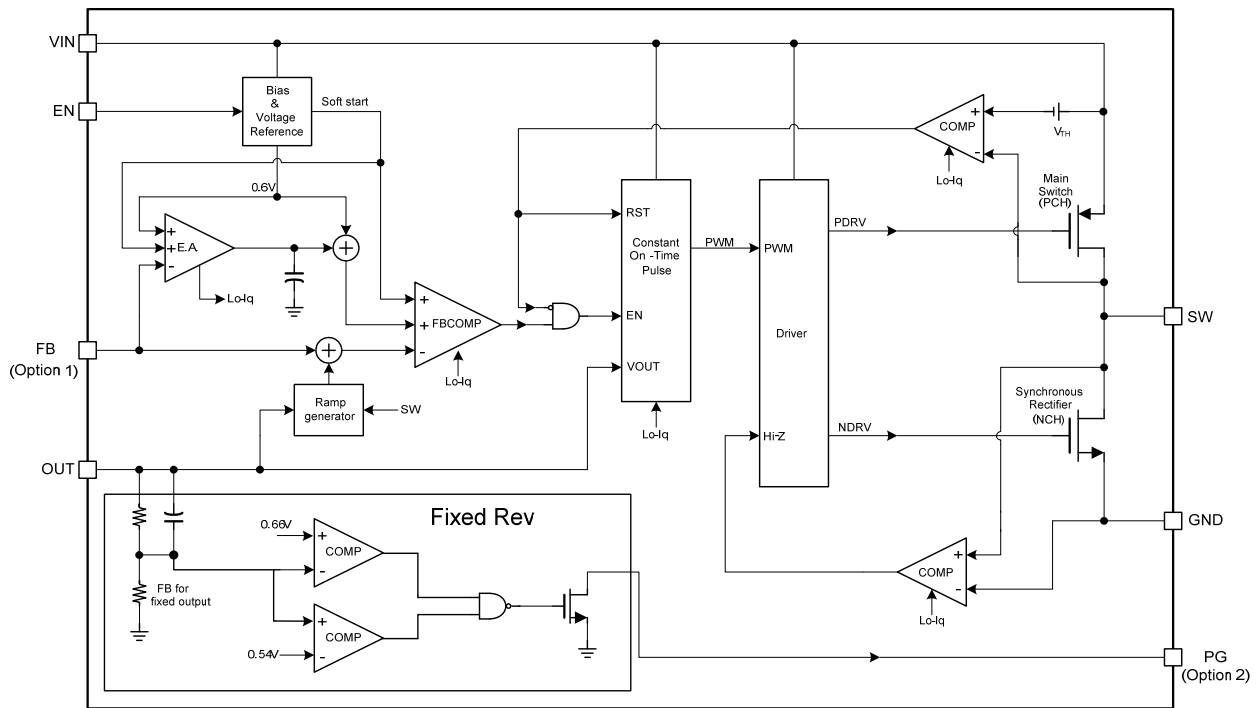

**Figure 1: Functional Block Diagram**

**NOTE:** Option 1: FB is only for MP2152XXX  
 Option 2: PG is only for MP2152XXX-XX

## OPERATION

The MP2152 uses constant-on-time (COT) control with input voltage feed-forward to stabilize the switching frequency over the entire input range. The MP2152 achieves 2A of continuous output current from a 2.5V to 5.5V input voltage with excellent load and line regulation. The output voltage can be regulated as low as 0.6V.

### Constant-On-Time (COT) Control

Compared to fixed-frequency pulse-width modulation (PWM) control, constant-on-time (COT) control offers a simpler control loop and faster transient response. By using input voltage feed-forward, the MP2152 maintains a nearly constant switching frequency across the input and output voltage ranges. The switching pulse on time can be estimated with Equation (1):

$$T_{ON} = \frac{V_{OUT}}{V_{IN}} \cdot 0.91\mu s \quad (1)$$

To prevent inductor current runaway during the load transient, the MP2152 has a fixed minimum off time of 100ns.

### Sleep Mode Operation

The MP2152 features sleep mode to achieve high efficiency at extremely light loads. In sleep mode, most of the circuit blocks are turned off except for the error amplifier and PWM comparator, reducing the operation current to a minimal value (see Figure 2).

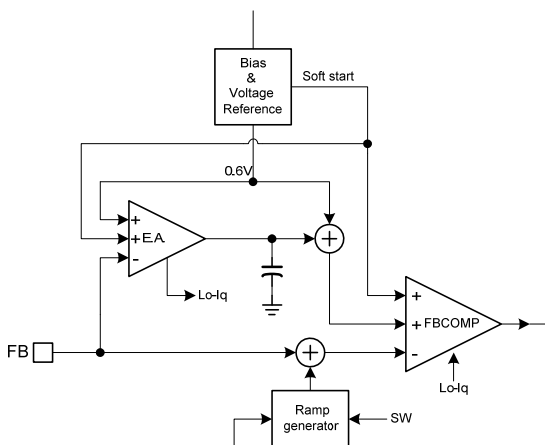

**Figure 2: Operation Blocks at Sleep Mode**

When the loading becomes lighter, the ripple of the output voltage becomes larger and drives the

error amplifier output (EAO) lower. When the EAO reaches the internal low threshold, it is clamped at that level, and the MP2152 enters sleep mode. During sleep mode, the valley of the FB voltage is regulated to the internal reference voltage, making the average output voltage slightly higher than the output voltage at discontinuous conduction mode (DCM) or continuous conduction mode (CCM). The on-time pulse at sleep mode is slightly larger than that in DCM or CCM. Figure 3 shows the average FB voltage's relationship with the internal reference at sleep mode.

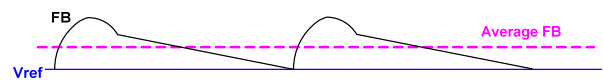

**Figure 3: FB Average Voltage at Sleep Mode**

When the MP2152 is in sleep mode, the average output voltage is higher than the internal reference voltage. The EAO is kept low and clamped in sleep mode. When the load increases, the PWM switching period decreases to keep the output voltage regulated, and the output voltage ripple decreases relatively. Once the EAO is higher than the internal low threshold, the MP2152 exits sleep mode and enters DCM or CCM depending on the load. In DCM or CCM, the EA regulates the average output voltage to the internal reference (see Figure 4).

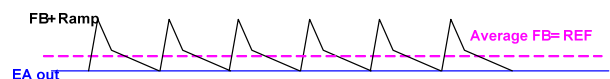

**Figure 4: DCM Control**

There is always a loading hysteresis when entering and exiting sleep mode due to the error amplifier clamping response time.

### AAM Operation at Light-Load Operation

The MP2152 uses advanced asynchronous mode (AAM) power-save mode together with a zero-current cross detection (ZCD) circuit for light-load operation.

The MP2152 uses AAM power-save mode for light load (see Figure 5). The AAM current (I<sub>AAM</sub>) is set internally. The SW on-pulse time is decided by the on-time generator and AAM comparator. In light-load condition, the SW on-

pulse time is the longer pulse. If the AAM comparator pulse is longer than the on-time generator, the operation mode is as shown in Figure 6.

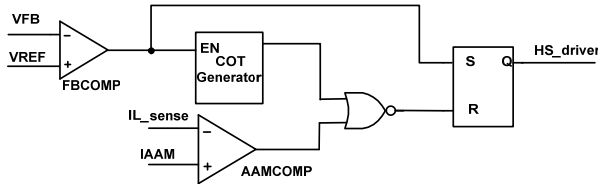

Figure 5: Simplified AAM Control Logic

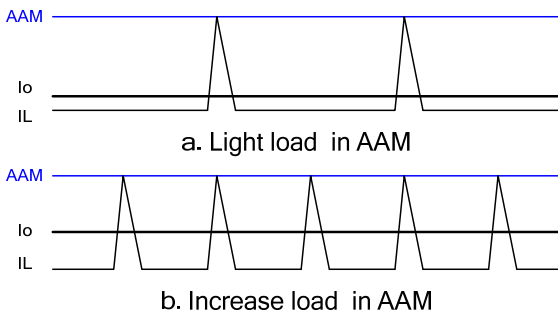

Figure 6: AAM Comparator Control T<sub>ON</sub>

If the AAM comparator pulse is shorter than the on-time generator, the operation mode is as shown in Figure 7.

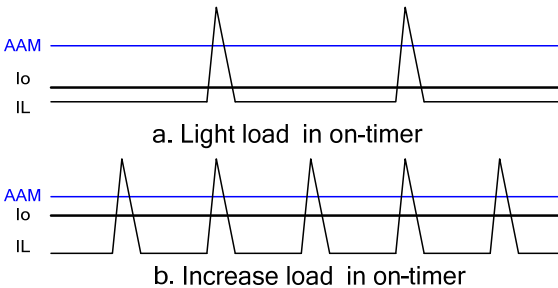

Figure 7: On-Time Control T<sub>ON</sub>

Figure 8 shows the AAM threshold decreasing as T<sub>ON</sub> increases gradually. For CCM, I<sub>o</sub> must be more than half of the AAM threshold at least. Generally, the AAM threshold is lower than the inductor current at normal duty cycles.

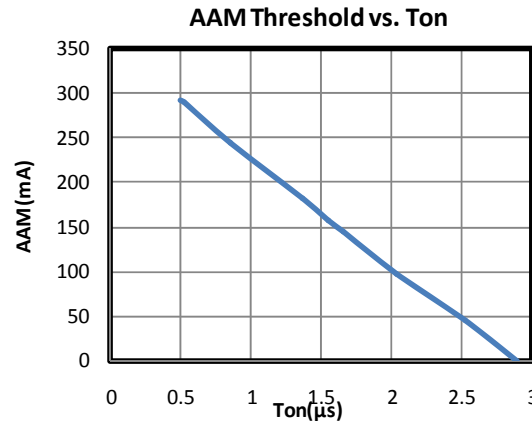

Figure 8: AAM Threshold Decreases as T<sub>ON</sub> Increases

The MP2152 uses a ZCD to determine if the inductor current has started reversing. When the inductor current reaches the ZCD threshold, the low-side switch turns off.

AAM together with a ZCD circuit makes the MP2152 always work in DCM at light load, even if V<sub>OUT</sub> is close to V<sub>IN</sub>.

**Enable (EN)**

If the input voltage is greater than the under-voltage lockout (UVLO) threshold (typically 2.3V), the MP2152 can be enabled by pulling EN higher than 1.2V. Leave EN floating or pull EN down to ground to disable the MP2152. There is an internal 1MΩ resistor from EN to ground.

When the device is disabled, the MP2152 enters output discharge mode automatically. Its internal discharge MOSFET provides a resistive discharge path for the output capacitor.

**Soft Start (SS)**

The MP2152 has a built-in soft start that ramps up the output voltage at a controlled slew rate to avoid overshooting at start-up. The soft-start time is about 0.5ms, typically.

**Current Limit**

The MP2152 has a typical minimum 2.8A high-side switch current limit. When the high-side switch reaches its current limit, the MP2152 remains in hiccup mode until the current drops. This prevents the inductor current from continuing to rise and damaging components.



### Short Circuit and Recovery

The MP2152 enters short-circuit protection (SCP) mode when it reaches its current limit and attempts to recover with hiccup mode. The MP2152 disables the output power stage, discharges the soft-start capacitor, and attempts to soft start again automatically. If the short-circuit condition remains after the soft start ends, the MP2152 repeats this cycle until the short circuit is removed and the output rises back to the regulation level.

### Over-Voltage Protection (VOUT OVP)

The MP2152 monitors the feedback voltage to detect over-voltage. When the feedback voltage becomes higher than 115% of the target voltage, the controller enters a dynamic regulation period. During this period, the low-side turns on until the low-side current drops to -1.5A. This discharges the output to keep it within the normal range. If the over-voltage condition still remains, the low-side turns on again after a 1 $\mu$ s delay. The MP2152 exits this regulation period when the feedback voltage decreases below 105% of the reference voltage. If the dynamic regulation cannot limit the increasing V<sub>OUT</sub>, once the input detects the 6.1V input, over-voltage protection (OVP) occurs, the MP2152 stops switching until the input voltage drops below 5.7V, and then the MP2152 resumes operation.

### Power Good Indicator (only for MP2152XXX-XX)

The MP2152XXX-XX has an open-drain output and requires an external pull-up resistor (100~500k $\Omega$ ) for the power good indicator. When V<sub>FB</sub> is within -10%/+15% of the regulation voltage, V<sub>PG</sub> is pulled up to V<sub>OUT</sub>/V<sub>IN</sub> by the external resistor. If V<sub>FB</sub> exceeds this window, the internal MOSFET pulls PG to ground. The MOSFET has a maximum R<sub>DS(ON)</sub> of less than 400 $\Omega$ .

## APPLICATION INFORMATION

### Setting the Output Voltage

The external resistor divider sets the output voltage (see the Typical Application on page 20). Select a feedback resistor (R1) value to reduce the V<sub>OUT</sub> leakage current, typically between 100 - 200kΩ. There is no strict requirement on the feedback resistor. An R1 value greater than 10kΩ is reasonable for applications. R2 can then be calculated with Equation (2):

$$R2 = \frac{R1}{\frac{V_{out}}{0.6} - 1} \quad (2)$$

Figure 9 shows the feedback circuit.

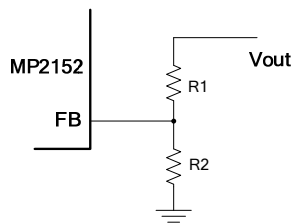

**Figure 9: Feedback Network**

Table 1 lists the recommended resistor values for common output voltages.

**Table 1: Resistor Values for Common Output Voltages**

| V <sub>OUT</sub> (V) | R1 (kΩ)  | R2 (kΩ)   |
|----------------------|----------|-----------|
| 1.0                  | 200 (1%) | 300 (1%)  |
| 1.2                  | 200 (1%) | 200 (1%)  |
| 1.8                  | 200 (1%) | 100 (1%)  |
| 2.5                  | 200 (1%) | 63.2 (1%) |
| 3.3                  | 200 (1%) | 44.2 (1%) |

### Selecting the Inductor

Most applications work best with a 1 - 2.2µH inductor. Select an inductor with a DC resistance less than 50mΩ to optimize efficiency.

A high-frequency switch-mode power supply with a magnetic device has strong electronic magnetic inference. Any unshielded power inductors should be avoided. Metal alloy or multi-layer chip power inductors are ideal shielded inductors since they can decrease the influence effectively.

The input capacitor can be electrolytic, tantalum, or ceramic. When using electrolytic or tantalum

Table 2 lists some recommended inductors.

**Table 2: Suggested Inductor List**

| Manufacturer P/N | Inductance (µH) | Manufacturer    |
|------------------|-----------------|-----------------|
| PIFE25201B-1R0MS | 1.0             | CYNTEC CO. LTD. |
| 74437324010      | 1.0             | Würth           |

For most designs, estimate the inductance value with Equation (3):

$$L_1 = \frac{V_{OUT} \times (V_{IN} - V_{OUT})}{V_{IN} \times \Delta I_L \times f_{OSC}} \quad (3)$$

Where ΔI<sub>L</sub> is the inductor ripple current.

Choose the inductor current to be approximately 30% of the maximum load current. The maximum inductor peak current can be calculated with Equation (4):

$$I_{L(MAX)} = I_{LOAD} + \frac{\Delta I_L}{2} \quad (4)$$

### Selecting the Input Capacitor

The input current to the step-down converter is discontinuous and therefore requires a capacitor to supply AC current to the step-down converter while maintaining the DC input voltage. Use low ESR capacitors for the best performance. Ceramic capacitors with X5R or X7R dielectrics are highly recommended because of their low ESR and small temperature coefficients. For most applications, a 22µF capacitor is sufficient. Higher output voltages may require a 44µF capacitor to increase system stability.

The input capacitor requires an adequate ripple current rating since it absorbs the input switching current. Estimate the RMS current in the input capacitor with Equation (5):

$$I_{C1} = I_{LOAD} \times \sqrt{\frac{V_{OUT}}{V_{IN}} \left( 1 - \frac{V_{OUT}}{V_{IN}} \right)} \quad (5)$$

The worst-case scenario occurs at V<sub>IN</sub> = 2V<sub>OUT</sub>, shown in Equation (6):

$$I_{C1} = \frac{I_{LOAD}}{2} \quad (6)$$

For simplification, choose an input capacitor with an RMS current rating greater than half of the maximum load current.

capacitors, add a small, high-quality, 0.1µF ceramic capacitor as close to the IC as possible.

When using ceramic capacitors, ensure that they have enough capacitance to provide a sufficient charge to prevent excessive voltage ripple at the input. The input voltage ripple caused by the capacitance can be estimated with Equation (7):

$$\Delta V_{IN} = \frac{I_{LOAD}}{f_s \times C1} \times \frac{V_{OUT}}{V_{IN}} \times \left(1 - \frac{V_{OUT}}{V_{IN}}\right) \quad (7)$$

### Selecting the Output Capacitor

The output capacitor (C2) stabilizes the DC output voltage. Low ESR ceramic capacitors are recommended to limit the output voltage ripple. Estimate the output voltage ripple with Equation (8):

$$\Delta V_{OUT} = \frac{V_{OUT}}{f_s \times L_1} \times \left(1 - \frac{V_{OUT}}{V_{IN}}\right) \times \left(R_{ESR} + \frac{1}{8 \times f_s \times C2}\right) \quad (8)$$

Where L<sub>1</sub> is the inductor value, and R<sub>ESR</sub> is the equivalent series resistance (ESR) value of the output capacitor.

When using ceramic capacitors, the capacitance dominates the impedance at the switching frequency and causes most of the output voltage ripple. For simplification, the output voltage ripple can be estimated with Equation (9):

$$\Delta V_{OUT} = \frac{V_{OUT}}{8 \times f_s^2 \times L_1 \times C2} \times \left(1 - \frac{V_{OUT}}{V_{IN}}\right) \quad (9)$$

For tantalum or electrolytic capacitors, the ESR dominates the impedance at the switching frequency. For simplification, the output ripple can be approximated with Equation (10):

$$\Delta V_{OUT} = \frac{V_{OUT}}{f_s \times L_1} \times \left(1 - \frac{V_{OUT}}{V_{IN}}\right) \times R_{ESR} \quad (10)$$

The characteristics of the output capacitor also affect the stability of the regulation system.

### PCB Layout Guidelines

Efficient PCB layout of the switching power supplies is critical for stable operation. For the high-frequency switching converter, a poor layout design can result in poor line or load regulation and stability issues. For best results, refer to Figure 10 and follow the guidelines below.

1. Place the high-current paths (GND, VIN, and SW) very close to the device with short, direct, and wide traces.
2. Place the input capacitor as close to VIN and GND as possible.
3. Place the external feedback resistors next to FB.
4. Keep the switching node (SW) short and away from the feedback network.
5. Keep the V<sub>OUT</sub> sense line need as short as possible and away from the power inductor, especially the surrounding inductor.

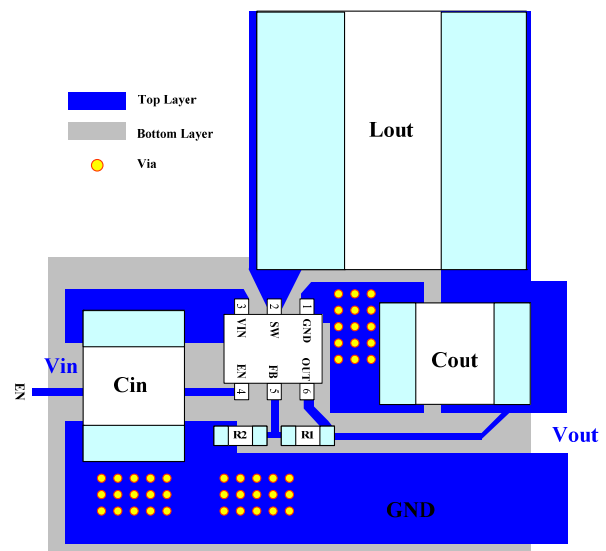

**Figure 10: Recommended Layout for the MP2152GTF**

### TYPICAL APPLICATION CIRCUITS

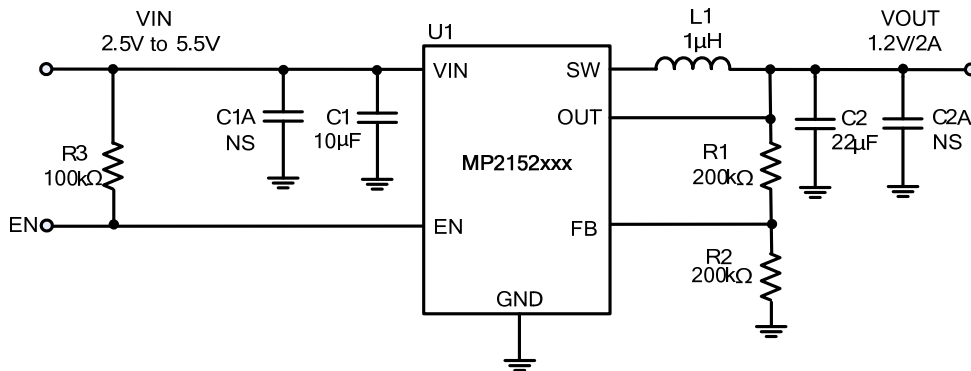

**Figure 11: Typical Application Circuit for MP2152xxx**

NOTE: VIN < 3.3V may require more input capacitors.

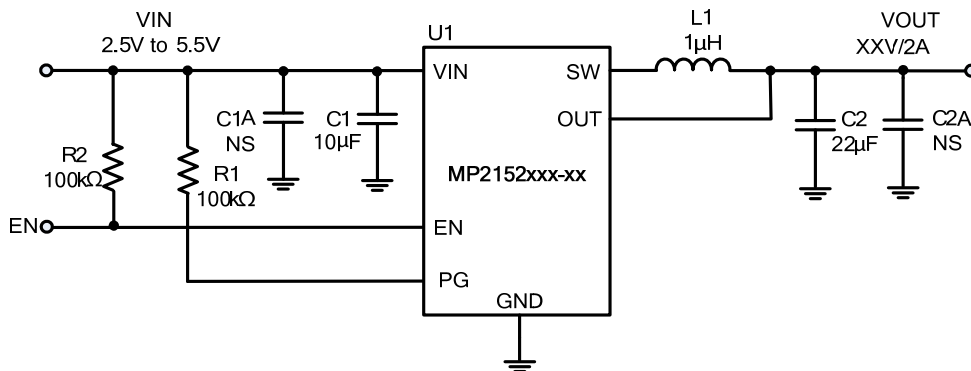
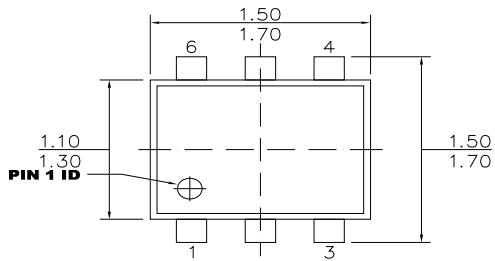

**Figure 12: Typical Application Circuit for MP2152xxx-xx**

NOTE: VIN < 3.3V may require more input capacitors.

**PACKAGE INFORMATION**

**SOT563**



**TOP VIEW**

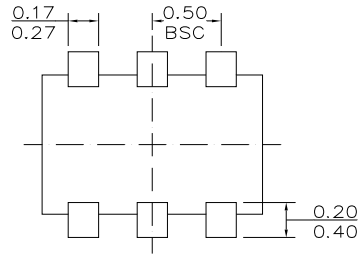

**BOTTOM VIEW**

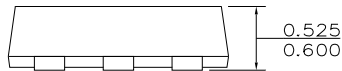

**FRONT VIEW**

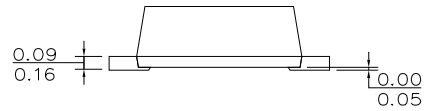

**SIDE VIEW**

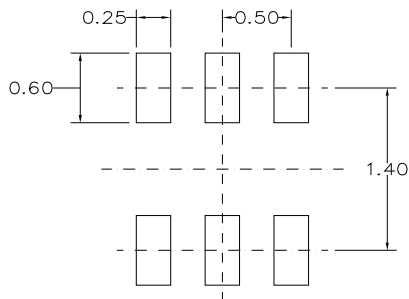

**RECOMMENDED LAND PATTERN**

**NOTE:**

- 1) ALL DIMENSIONS ARE IN MILLIMETERS.
- 2) PACKAGE LENGTH DOES NOT INCLUDE MOLD FLASH, PROTRUSION OR GATE BURR.
- 3) PACKAGE WIDTH DOES NOT INCLUDE INTERLEAD FLASH OR PROTRUSION.
- 4) LEAD COPLANARITY (BOTTOM OF LEADS AFTER FORMING) SHALL BE 0.10 MILLIMETERS MAX.
- 5) DRAWING IS NOT TO SCALE.