



The Future of Analog IC Technology®

MP5075

5.5V, 2.4A,

Low $R_{DS(ON)}$ Load Switch

DESCRIPTION

The MP5075 provides up to 2.4A of load protection over a 3V to 5.5V voltage range with a small $R_{DS(ON)}$ in a space-saving package. The MP5075 is a very high-efficiency and space-saving solution for notebooks, tablets, and other portable and battery-operated applications.

With a fixed soft-start function, the MP5075 can prevent inrush current during circuit start-up. The MP5075 also provides output discharge functions, over-current protection (OCP), and thermal shutdown features.

The max load at the output (source) is current-limited. This is accomplished by utilizing sense FET topology.

An internal charge pump drives the gate of the power device, allowing for a very low on-resistance DMOS power FET of just 38mΩ.

The MP5075 is available in a space-saving SOT563 (1.6mmx1.6mm) package.

FEATURES

- Integrated 38mΩ Low $R_{DS(ON)}$ MOSFETs
- Wide VIN Range from 3V to 5.5V
- <5μA Shutdown Current
- Typical 3A Current Limit
- Output Discharge Function
- Internal Fixed 450μs Soft-Start Time
- <200ns Short-Circuit Protection Response Time
- Thermal Protection
- Available in a SOT563 (1.6mmx1.6mm) Package

APPLICATIONS

- Notebook and Tablet Computers
- Portable Devices
- Solid-State Drives
- Handheld Devices
- USB Power Distribution
- USB Dongles

All MPS parts are lead-free, halogen-free, and adhere to the RoHS directive. For MPS green status, please visit the MPS website under Quality Assurance. "MPS" and "The Future of Analog IC Technology" are registered trademarks of Monolithic Power Systems, Inc.

TYPICAL APPLICATION

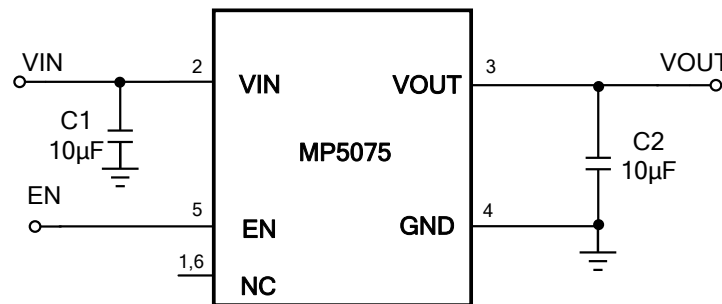

ORDERING INFORMATION

Part Number*	Package	Top Marking
MP5075GTF	SOT563	See Below

* For Tape & Reel, add suffix -Z (e.g. MP5075GTF-Z)

TOP MARKING

AVAY

LLL

AVA: Product code of MP5075GTF

Y: Year code

LLL: Lot number

PACKAGE REFERENCE

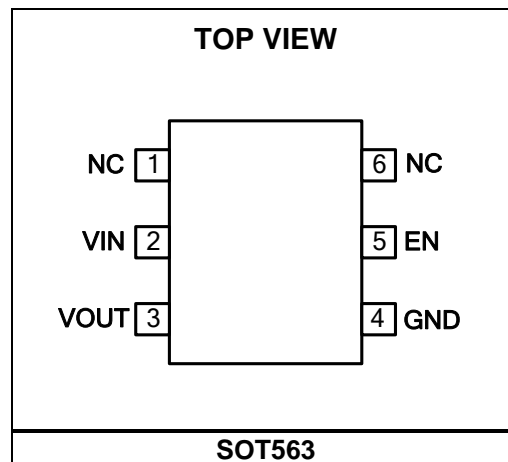

ABSOLUTE MAXIMUM RATINGS (1)

VIN	-0.3V to +6.5V
VOUT	-0.3V to +6.5V
EN	-0.3V to +6.5V
Junction temperature	150°C
Lead temperature	260°C
Continuous power dissipation (T _A = +25°C) (2)	
.....	1W

Recommended Operating Conditions (3)

Supply voltage (VIN)	3V to 5.5V
Output voltage (VOUT)	3V to 5.5V
Output current (I _{OUT})	2.4A
Operating junction temp. (T _J) ...	-40°C to +125°C

Thermal Resistance (4)	θ_{JA}	θ_{JC}	
SOT563	130.....	60...	°C/W

NOTES:

- 1) Exceeding these ratings may damage the device.
- 2) The maximum allowable power dissipation is a function of the maximum junction temperature T_J (MAX), the junction-to-ambient thermal resistance θ_{JA}, and the ambient temperature T_A. The maximum allowable continuous power dissipation at any ambient temperature is calculated by P_D (MAX) = (T_J (MAX)-T_A)/θ_{JA}. Exceeding the maximum allowable power dissipation produces an excessive die temperature, causing the regulator to go into thermal shutdown. Internal thermal shutdown circuitry protects the device from permanent damage.
- 3) The device is not guaranteed to function outside of its operating conditions.
- 4) Measured on JESD51-7, 4-layer PCB.

ELECTRICAL CHARACTERISTICS

V_{IN} = 5V, T_J = -40°C to 125°C ⁽⁵⁾, typical value is tested at T_J = 25°C, unless otherwise noted.

Parameters	Symbol	Condition	Min	Typ	Max	Units
Input and Supply Voltage Range						
Input voltage	V _{IN}		3		5.5	V
Supply Current						
Off-state leakage current	I _{OFF}	V _{IN} = 5V, EN = 0			5	μA
V _{IN} standby current	I _{STBY}	V _{IN} = 5V, EN = 0			5	μA
		V _{IN} = 5V, enable, no load		230	300	
Power FET						
On resistance	R _{DS(ON)}	V _{IN} = 5V		38		mΩ
		V _{IN} = 3.3V		48		
Thermal Shutdown and Recovery						
Shutdown temperature ⁽⁶⁾	T _{STD}			150		°C
Hysteresis ⁽⁶⁾	T _{HYS}			30		°C
Under-Voltage Protection (UVLO)						
V _{IN} under-voltage lockout threshold	V _{IN_UVLO}	UVLO rising threshold	2.3	2.6	2.9	V
UVLO hysteresis	V _{UVLO-HYS}			200		mV
Soft Start (SS)						
SS time	T _{SS}	0% to 100%		450		μs
Enable (EN)						
EN rising threshold	V _{ENH}		1.3	1.5	1.7	V
EN hysteresis	V _{EN-HYS}			200		mV
EN pull-down resistor	R _{PUD}			1		MΩ
ILIM						
Current limit	I _{OUT}		2.6	3	3.4	A
Discharge Resistance						
Discharge resistance	R _{DIS}			150		Ω

NOTES:

- 5) Guaranteed by over-temperature correlation, not tested in production.
- 6) Guaranteed by characterization, not tested in production.

TYPICAL PERFORMANCE CHARACTERISTICS

$V_{IN} = EN = 5V$, $T_A = 25^\circ C$, unless otherwise noted.

Quiescent Current vs. Input Voltage

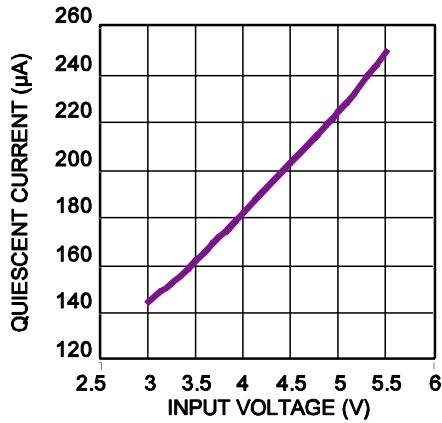

Shutdown Current vs. Input Voltage

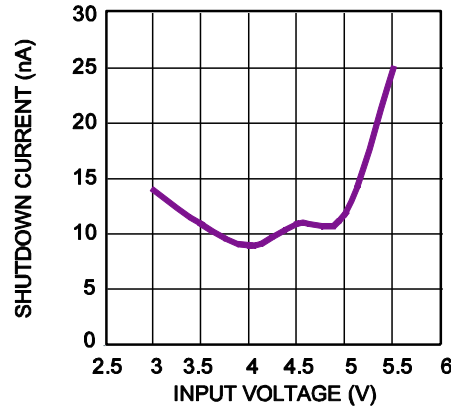

V_{IN} UVLO Rising Threshold vs. Temperature

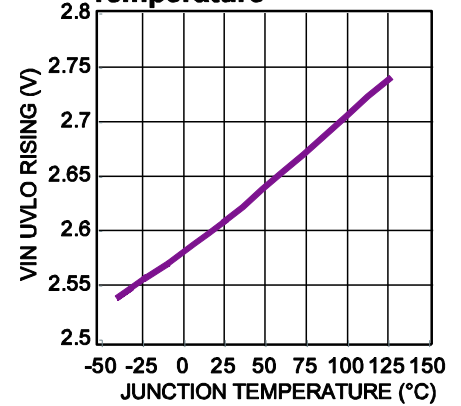

V_{in} UVLO Falling Threshold vs. Temperature

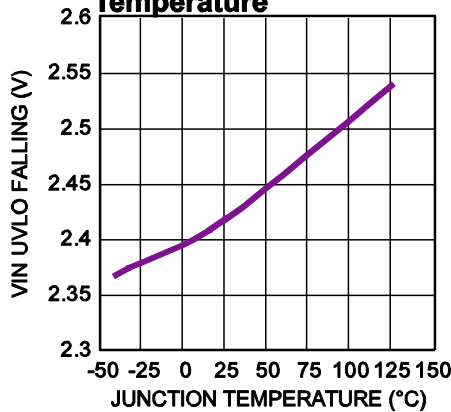

E_n Rising Threshold vs. Temperature

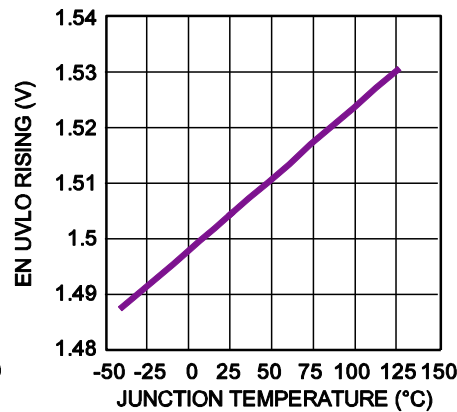

E_n Falling Threshold vs. Temperature

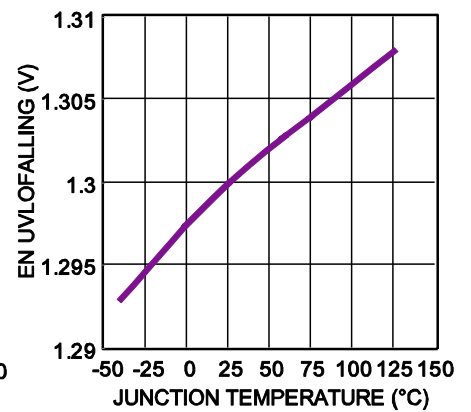

Current Limit vs. Input Voltage

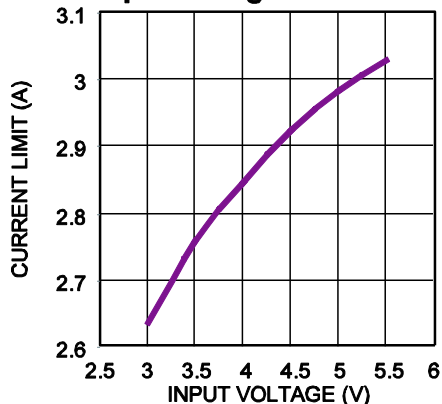

$R_{ds(ON)}$ vs. Input Voltage

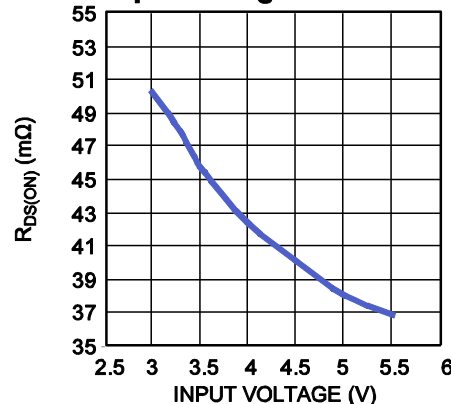

TYPICAL PERFORMANCE CHARACTERISTICS (continued)

$V_{IN} = E_N = 5V$, $T_A = 25^\circ C$, unless otherwise noted.

Start-Up through Input Voltage

$E_N=5V$, $I_{OUT}=0A$

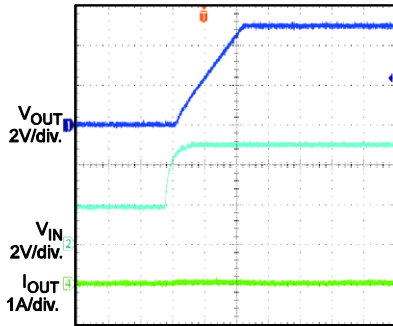

200 μ s/div.

Start-Up through Input Voltage

$E_N=5V$, $I_{OUT}=0A$, $C_{OUT}=470\mu F$

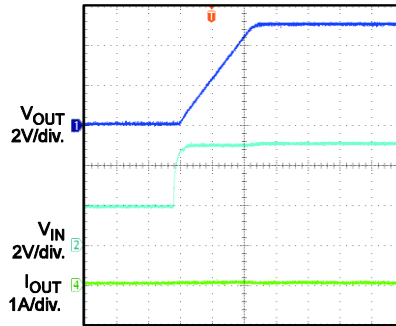

400 μ s/div.

Start-Up through Input Voltage

$E_N=5V$, $I_{OUT}=2.4A$

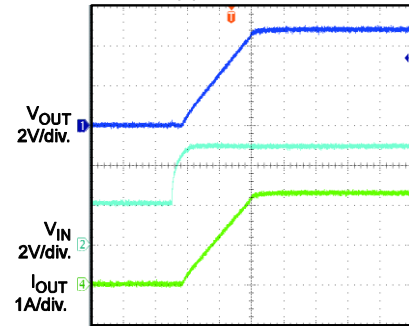

200 μ s/div.

Shutdown through Input Voltage

$E_N=5V$, $I_{OUT}=0A$

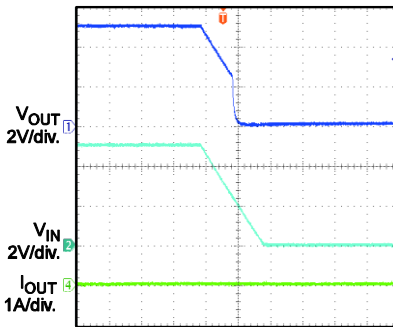

40ms/div.

Shutdown through Input Voltage

$E_N=5V$, $I_{OUT}=0A$, $C_{OUT}=470\mu F$

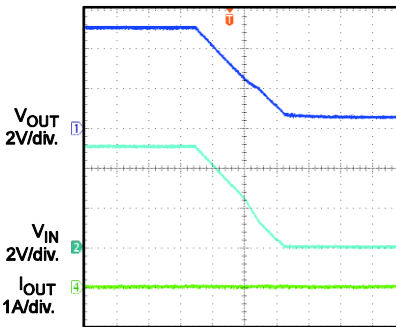

40ms/div.

Shutdown through Input Voltage

$E_N=5V$, $I_{OUT}=2.4A$

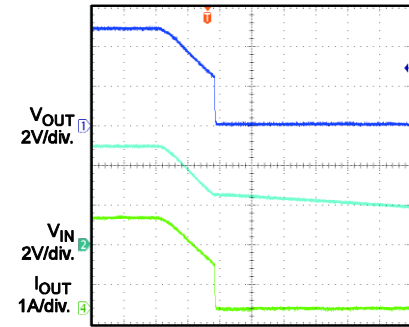

2ms/div.

Start-Up through EN

$E_N=5V$, $I_{OUT}=0A$

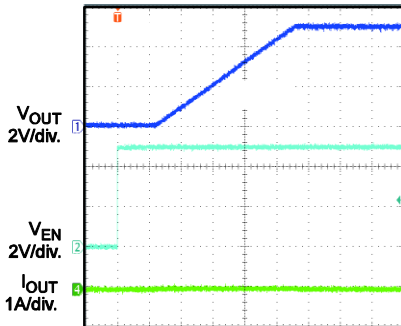

200 μ s/div.

Start-Up through EN

$E_N=5V$, $I_{OUT}=0A$, $C_{OUT}=470\mu F$

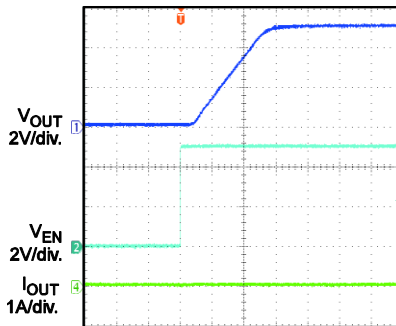

400 μ s/div.

Start-Up through EN

$E_N=5V$, $I_{OUT}=2.4A$

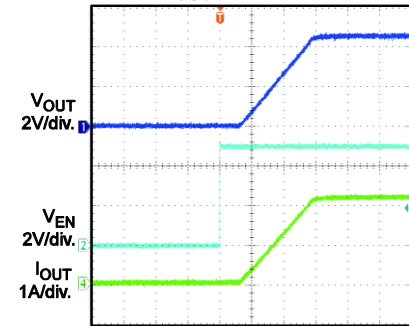

200 μ s/div.

TYPICAL PERFORMANCE CHARACTERISTICS (continued)

$V_{IN} = EN = 5V$, $T_A = 25^\circ C$, unless otherwise noted.

Shutdown through EN

$V_{IN}=5V, I_{OUT}=0A$

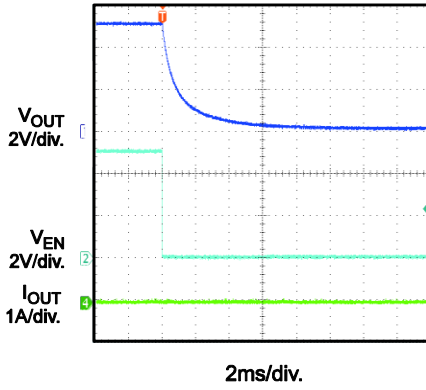

Shutdown through EN

$V_{IN}=5V, I_{OUT}=0A, C_{OUT}=470\mu F$

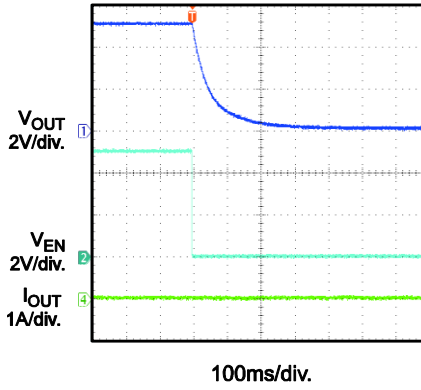

Shutdown through EN

$V_{IN}=5V, I_{OUT}=2.4A$

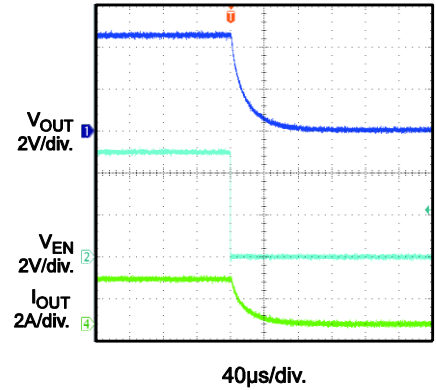

OCP Current Limit with Resistive Load

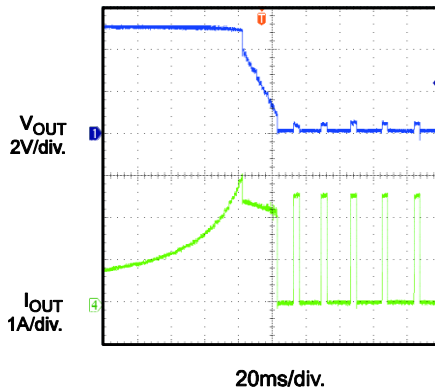

SCP Entry

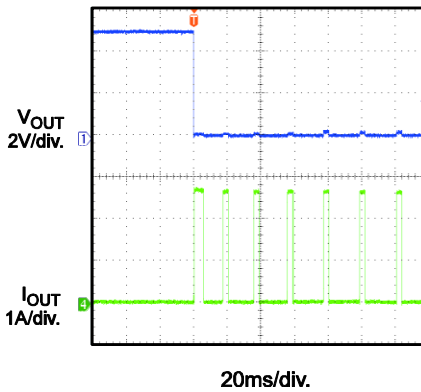

SCP Recovery

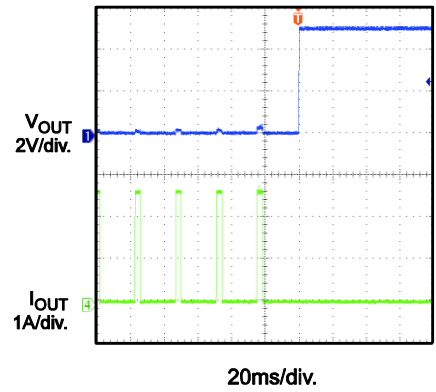

PIN FUNCTIONS

SOT563 Pin #	Name	Description
1, 6	NC	No connection.
2	VIN	Input power supply.
3	VOUT	Output to the load.
4	GND	Ground.
5	EN	Enable input. EN has an internal 1M Ω pull-down resistor. Float EN to shut down the IC.

BLOCK DIAGRAM

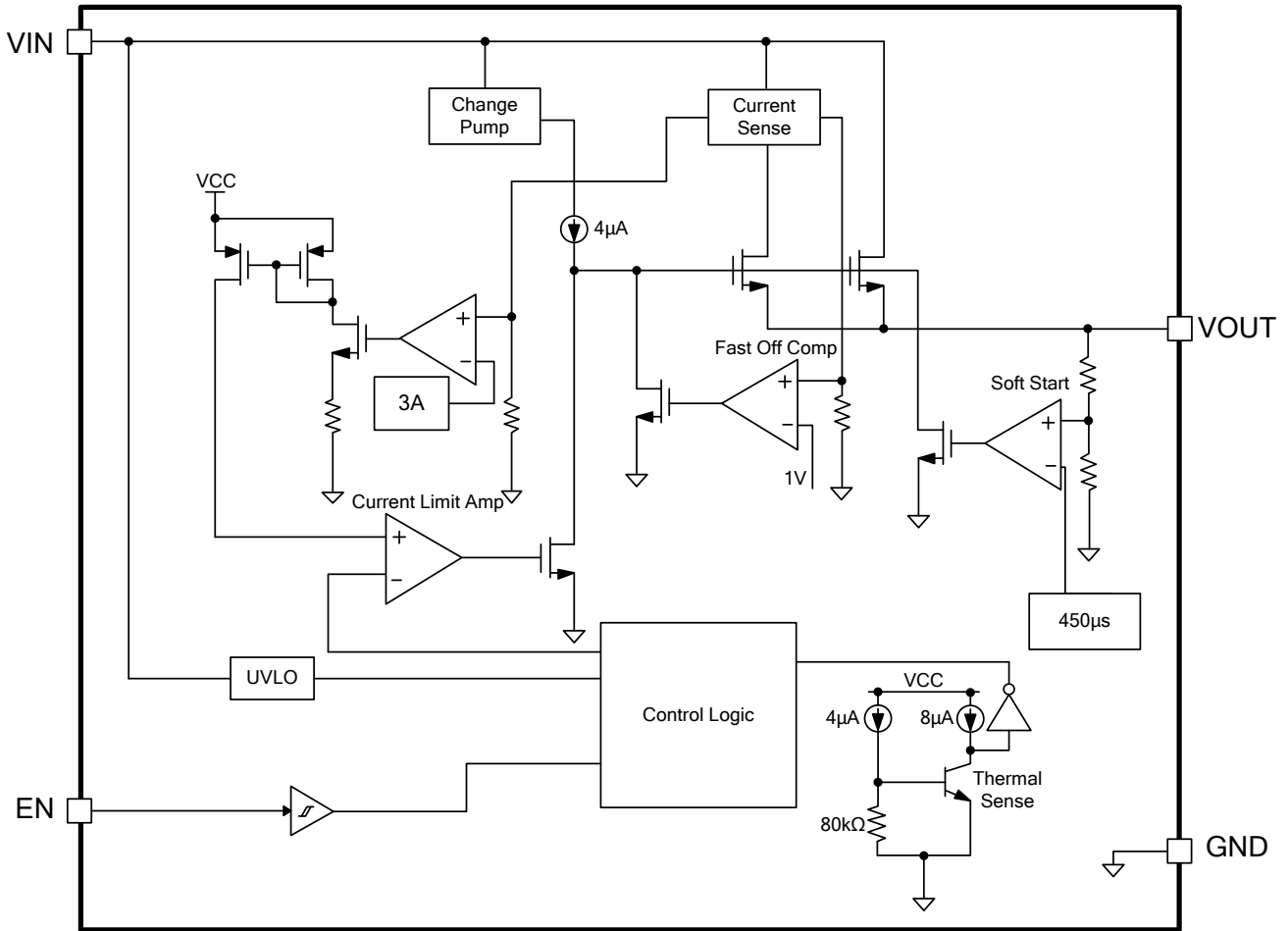

Figure 1: Functional Block Diagram

OPERATION

The MP5075 is designed to limit the inrush current to the load when a circuit card is inserted into a live backplane power source, thereby limiting the backplane's voltage drop and the slew rate of the voltage to the load. The MP5075 provides an integrated solution to monitor the input voltage, output voltage, and output current to eliminate the need for an external current power MOSFET and current switch device.

Enable (EN)

When the input voltage is greater than the under-voltage lockout (UVLO) threshold (typically 2.6V), the MP5075 can be enabled by pulling EN above 1.5V. Pull EN down to ground to disable the MP5075.

Current Limit

The MP5075 provides an internal, fixed, 3A, constant current limit. Once the device reaches its current limit threshold, the internal circuit regulates the gate voltage to hold the current in the power MOSFET constant. The typical response time is about 20 μ s. The output current may have a small overshoot during this time period.

If the current limit block starts to regulate the output current, the power loss on the power MOSFET causes the IC temperature to rise. If the junction temperature rises high enough, thermal shutdown is triggered. After thermal shutdown occurs, the output is disabled until the over temperature fault is removed. The over-temperature threshold is 150°C, and hysteresis is 30°C.

Short-Circuit Protection (SCP)

If the load current increases rapidly due to a short circuit, the current may exceed the current limit threshold greatly before the control loop can respond. If the current reaches an internal secondary current limit level (typically 7A), a fast turn-off circuit activates to turn off the power MOSFET. This limits the peak current through the switch to limit the input voltage drop. The total short-circuit response time is about 200ns. If fast turn-off is effective, the power MOSFET remains off for 80 μ s. Afterward, the power MOSFET is turned on again. If the part is still in the short-circuit condition, the MP5075 enters

current limit until the part is hot enough to trigger thermal shutdown. After the short-circuit condition is removed, the MP5075 auto-retries after the silicon temperature drops.

Output Discharge

The MP5075 has an output discharge function. This function can discharge VOUT by the internal pull-down resistance when the IC is disabled and the load is very light.

Soft Start (SS)

Soft start prevents large inrush current. The soft-start time is set to 450 μ s internally.

PCB Layout Guidelines

Efficient PCB layout is critical for stable operation. For best results, refer to Figure 2 and follow the guidelines below.

1. Place an input capacitor close to VIN.
2. Connect NC to GND for an easier layout.
3. Place enough vias around the IC and enough copper area near VIN and VOUT to achieve better thermal performance.

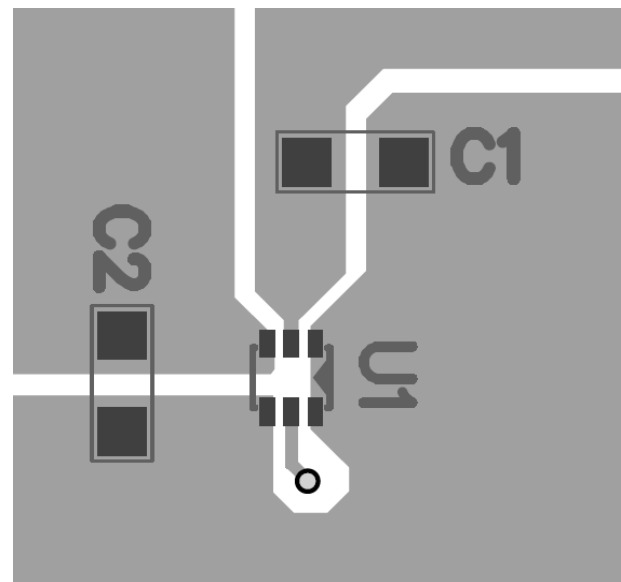

Figure 2: Recommended Layout

TYPICAL APPLICATION CIRCUIT