



DESCRIPTION

The MP5098 is a 12V/5V, low quiescent current (I_Q), low on resistance ($R_{DS(ON)}$), dual-channel e-fuse protection device with current monitoring. It protects output circuitry from input transients, as well as protects input circuitry from output shorts and transients.

At start-up, the inrush current is limited by limiting the output slew rate. The slew rate is controlled via the SS pin capacitor (C_{SS}).

The maximum load current (I_{LOAD_MAX}) at the output is current-limited. The magnitude of the current limit (I_{LIMIT}) is fixed internally.

Full protection features include output over-voltage protection (OVP), over-current protection (OCP), short-circuit protection (SCP), and thermal shutdown.

The output voltage (V_{OUT}) is limited by output OVP. Each rail's output current (I_{OUT}) can be monitored via a resistor connected between the IMON1 and IMON2 pins.

The MP5098 is available in a space-saving TQFN-10 (2mmx3mm) package.

FEATURES

- 12V/5V Integrated Dual E-Fuse
- Dual-Channel Current Limiting
- 24V/100ms Maximum Surge Input Voltage (V_{IN}) Tolerance for 12V Bus and 5V Bus
- 40m Ω Low On Resistance ($R_{DS(ON)}$)
- Low Quiescent Current (I_Q):
 - 210 μ A I_Q for 12V Bus
 - 190 μ A I_Q for 15V Bus
- Configurable Soft-Start Time (t_{SS})
- Fixed Trip/Hold Current Limit (I_{LIMIT}):
 - Fixed 4A Trip I_{LIMIT} for 12V Bus
 - Fixed 2.5A Hold I_{LIMIT} for 12V Bus
 - Fixed 3A Trip I_{LIMIT} for 5V Bus
 - Fixed 1.3A Hold I_{LIMIT} for 5V Bus
- 15V Over-Voltage Protection (OVP) Threshold for 12V V_{IN} Channel
- 5.7V OVP Threshold for 5V V_{IN} Channel
- Over-Current Protection (OCP) with Hiccup Mode
- Short-Circuit Protection (SCP)
- Thermal Shutdown (Latch-Off Protection)
- Available in a TQFN-10 (2mmx3mm) Package

APPLICATIONS

- Hard-Disk Drives (HDDs)
- Solid-State Drives (SSDs)
- Hot Swap Applications

All MPS parts are lead-free, halogen-free, and adhere to the RoHS directive. For MPS green status, please visit the MPS website under Quality Assurance. "MPS", the MPS logo, and "Simple, Easy Solutions" are trademarks of Monolithic Power Systems, Inc. or its subsidiaries.

TYPICAL APPLICATION

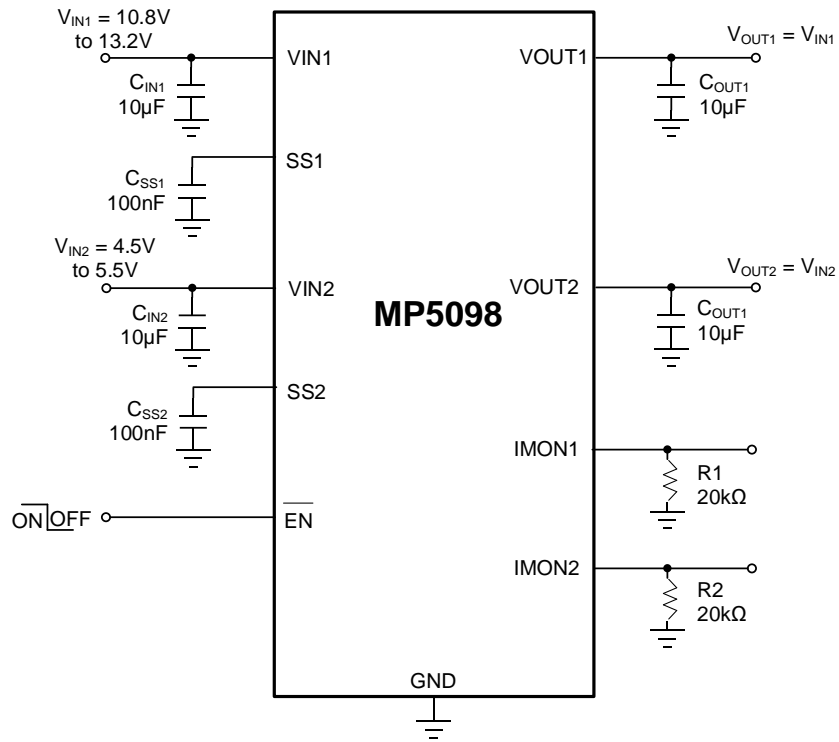

ORDERING INFORMATION

Part Number*	Package	Top Marking	MSL Rating
MP5098GDT	TQFN-10 (2mmx3mm)	See Below	1

* For Tape & Reel, add suffix -Z (e.g. MP5098GDT-Z).

TOP MARKING

BLB
YWW
LLL

BLB: Product code of MP5098GDT
 Y: Year code
 WW: Week code
 LLL: Lot number

PACKAGE REFERENCE

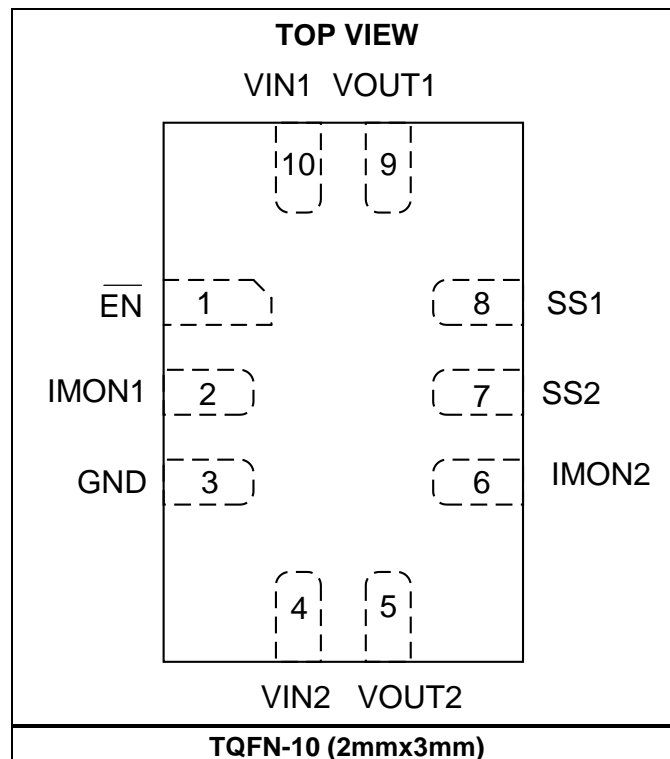

PIN FUNCTIONS

Pin #	Name	Description
1	$\overline{\text{EN}}$	Channel 1 and channel 2 enable. The $\overline{\text{EN}}$ pin is a digital input that turns the regulator on and off. Float $\overline{\text{EN}}$ or pull $\overline{\text{EN}}$ low to turn the regulator on; pull $\overline{\text{EN}}$ high to turn it off.
2	IMON1	Channel 1 current monitoring. Connect a resistor between the IMON1 and GND pins to set the current monitor gain.
3	GND	System ground.
4	VIN2	Channel 2 supply voltage. Channel 2's typical input voltage (V_{IN}) is 5V. Use a ceramic decoupling capacitor to decouple the VIN2 pin. Connect VIN2 using a wide PCB trace.
5	VOUT2	Channel 2 output terminal.
6	IMON2	Channel 2 current monitoring. Connect a resistor between the IMON2 and GND pins to set the current monitor gain.
7	SS2	Channel 2 soft start. Connect a capacitor between the SS2 and GND pins to set channel 2's soft-start time (t_{SS}).
8	SS1	Channel 1 soft start. Connect a capacitor between the SS1 and GND pins to set channel 1's t_{SS} .
9	VOUT1	Channel 1 output terminal.
10	VIN1	Channel 1 supply voltage. Channel 2's typical input voltage (V_{IN}) is 12V. Use a ceramic decoupling capacitor to decouple the VIN1 pin. Connect VIN1 using a wide PCB trace.

ABSOLUTE MAXIMUM RATINGS ⁽¹⁾

$V_{\text{IN1}}, V_{\text{OUT1}}$	-0.3V to +22V
Input positive transient (CH1 = 100ms)	24V
$V_{\text{IN2}}, V_{\text{OUT2}}$	-0.3V to +15V
Input positive transient (CH2 = 100ms)	24V
All other pins	-0.3V to +5V
Junction temperature	-40°C to +150°C
Lead temperature	260°C
Continuous Power Dissipation ($T_{\text{A}} = 25^{\circ}\text{C}$) ⁽²⁾⁽⁴⁾	
TQFN-10 (2mmx3mm)	3.1W

ESD Ratings

Human body model (HBM)	2000V
Charged device model (CDM)	1750V

Recommended Operating Conditions ⁽³⁾

CH1 continuous voltage	10.8V to 13.8V
CH2 continuous voltage	4.6V to 5.5V
Operating junction temp (T_{J})	-40°C to +125°C

Thermal Resistance

 $\theta_{\text{JA}} \quad \theta_{\text{JC}}$

TQFN-10 (2mmx3mm)

 EV5098-D-00A ⁽⁴⁾ 40 4 °C/W

 JESD51-7 ⁽⁵⁾ 70 5 °C/W

Notes:

- 1) Exceeding these ratings may damage the device.
- 2) The maximum allowable power dissipation is a function of the maximum junction temperature T_{J} (MAX), the junction-to-ambient thermal resistance θ_{JA} , and the ambient temperature T_{A} . The maximum allowable continuous power dissipation at any ambient temperature is calculated by $P_{\text{D}} (\text{MAX}) = (T_{\text{J}} (\text{MAX}) - T_{\text{A}}) / \theta_{\text{JA}}$. Exceeding the maximum allowable power dissipation can produce an excessive die temperature, which may cause the regulator to go into thermal shutdown. Internal thermal shutdown circuitry protects the device from permanent damage.
- 3) The device is not guaranteed to function outside of its operating conditions.
- 4) Measured on the EV5098-D-00A, 2-layer PCB, 54mmx46mm.
- 5) The value of θ_{JA} given in this table is only valid for comparison with other packages and cannot be used for design purposes. These values were calculated in accordance with JESD51-7, and simulated on a specified JEDEC board. They do not represent the performance obtained in an actual application.

ELECTRICAL CHARACTERISTICS

$V_{IN1} = 12V$, $V_{IN2} = 5V$, $C_{OUT1} = C_{OUT2} = 10\mu F$, $T_J = -40^{\circ}C$ to $+125^{\circ}C$ ⁽⁶⁾, typical values are tested at $T_J = 25^{\circ}C$, unless otherwise noted.

Parameter	Symbol	Condition	Min	Typ	Max	Units
Supply Current						
Quiescent current	I_{Q_CH1}	V_{EN} is low		210		μA
	I_{Q_CH2}	V_{EN} is low		190		μA
Shutdown current	I_{SD_CH1}	V_{EN} is high		15		μA
	I_{SD_CH2}	V_{EN} is high		10		μA
Power MOSFET						
On resistance	$R_{DS(ON)_CH1}$	$T_J = 25^{\circ}C$		40	50	$m\Omega$
		$T_J = 125^{\circ}C$			65	$m\Omega$
	$R_{DS(ON)_CH2}$	$T_J = 25^{\circ}C$		40	50	$m\Omega$
		$T_J = 125^{\circ}C$			65	$m\Omega$
Start-up delay	$t_{EN_DELAY_CH1}$	From V_{EN} is low to I_{OUT1} rises up to 100mA, with 1A load resistor, SS1 is floating		220		μs
	$t_{EN_DELAY_CH2}$	From V_{EN} is low to I_{OUT2} rises up to 100mA, with 1A load resistor, SS2 is floating		220		μs
Under-Voltage Lockout (UVLO) Protection and Over-Voltage Protection (OVP)						
UVLO rising threshold	$V_{UVLO_RISING_CH1}$		9.6	10	10.4	V
	$V_{UVLO_RISING_CH2}$		4.25	4.35	4.45	V
UVLO falling threshold	$V_{UVLO_FALLING_CH1}$			9.1		V
	$V_{UVLO_FALLING_CH2}$			2.65		V
Output OVP threshold	V_{OVP_CH1}		13.8	15	16	V
	V_{OVP_CH2}		5.5	5.7	5.9	V
Output OVP response time ⁽⁷⁾	t_{OVP_CH1}	$C_{OUT1} = 10\mu F$ with 30 Ω load resistor, $V_{IN1} = 12V$ to 18V/10 μs		2		μs
	t_{OVP_CH2}	$C_{OUT2} = 10\mu F$ with 10 Ω load resistor, $V_{IN2} = 5V$ to 7V/10 μs		2		μs
Current Limit (I_{LIMIT})						
I_{LIMIT} during normal operation	I_{LIMIT_CH1}		-10%	4	+10%	A
	I_{LIMIT_CH2}		-10%	3	+10%	A
Constant-current limit during normal operation	$I_{LIMIT_CC_CH1}$ ⁽⁷⁾			2.5		A
	$I_{LIMIT_CC_CH2}$ ⁽⁷⁾			1.3		A
I_{LIMIT} response time ⁽⁷⁾	t_{CL_CH1}			15		μs
	t_{CL_CH2}			15		μs
Secondary I_{LIMIT} ⁽⁷⁾	$I_{LIMIT_SEC_CC_CH1}$			8		A
	$I_{LIMIT_SEC_CC_CH2}$			8		A

ELECTRICAL CHARACTERISTICS (continued)

$V_{IN1} = 12V$, $V_{IN2} = 5V$, $C_{OUT1} = C_{OUT2} = 10\mu F$, $T_J = -40^{\circ}C$ to $+125^{\circ}C$ ⁽⁶⁾, typical values are tested at $T_J = 25^{\circ}C$, unless otherwise noted.

Parameter	Symbol	Condition	Min	Typ	Max	Units
Hiccup mode on time	t _{ON_HICCUP}			2		ms
Hiccup mode off time	t _{OFF_HICCUP}			200		ms
Current Monitoring (IMON1/IMON2)						
Current-sense gain	G _{IMON1}			32		$\mu A/A$
	G _{IMON2}			34		$\mu A/A$
Current-sense offset	I _{OFFSET_CH1}		0.45	2	3.5	μA
	I _{OFFSET_CH2}		0.8	2.3	3.8	μA
Current monitor voltage range ⁽⁷⁾	V _{IMON}		0		2.5	V
Enable (EN) Control						
\overline{EN} falling threshold	V _{EN_FALLING}		0.95	1.15	1.35	V
\overline{EN} hysteresis	V _{EN_HYS}			800		mV
\overline{EN} pull down resistance	R _{EN_PD}			0.77		M Ω
Soft Start (SS)						
Soft-start current	I _{SS_CH1}		4	5.5	7	μA
	I _{SS_CH2}		4	5.5	7	μA
Thermal Shutdown						
Thermal shutdown ⁽⁷⁾	T _{SD}			155		$^{\circ}C$

Notes:

- 6) Guaranteed by over-temperature correlation. Not tested in production.
 7) Guaranteed by engineering sample characterization.

TYPICAL CHARACTERISTICS

$V_{IN1} = 12V$, $V_{IN2} = 5V$, $T_A = 25^\circ C$, unless otherwise noted.

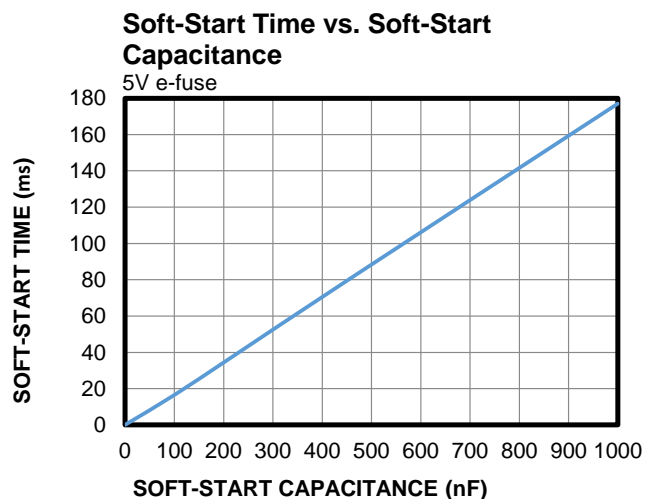
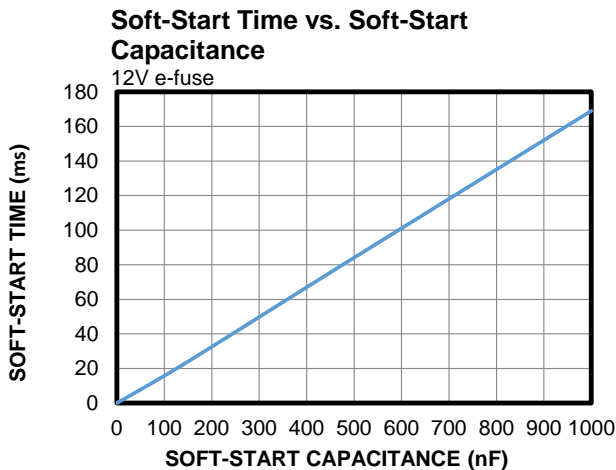
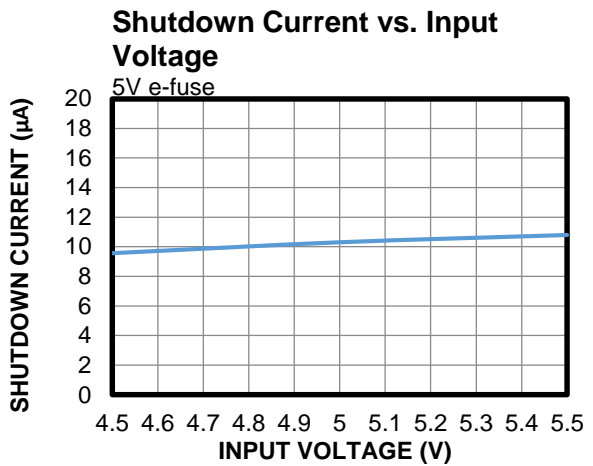
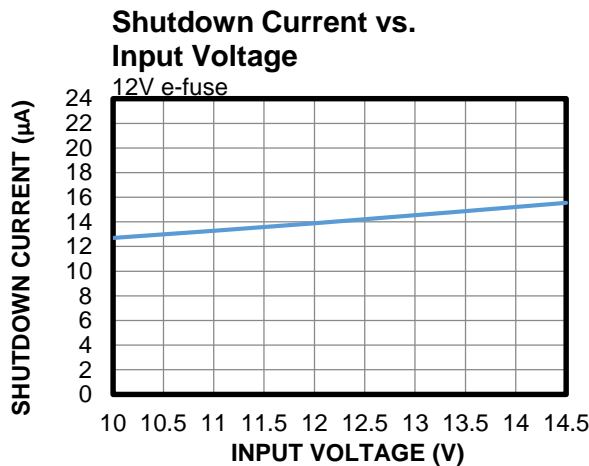
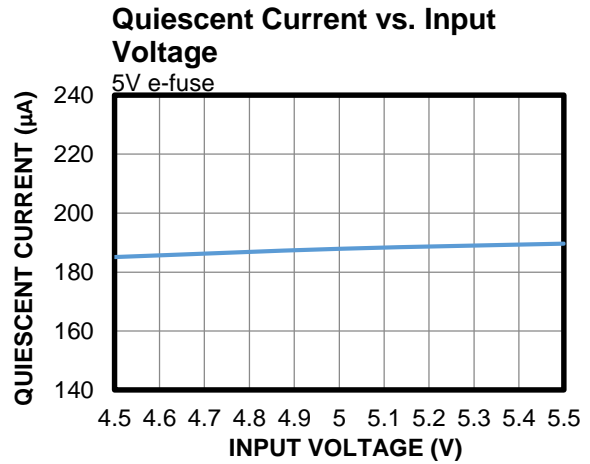
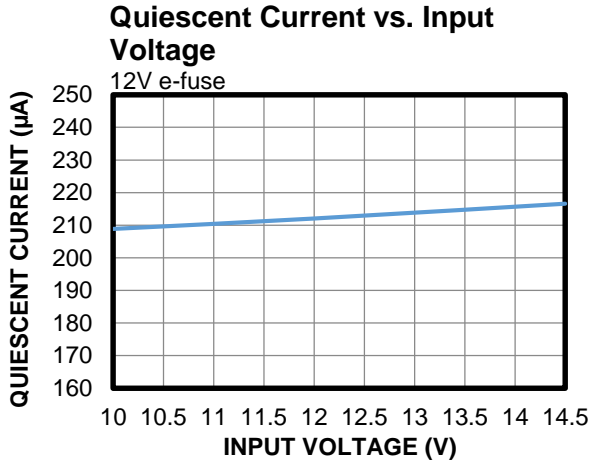

TYPICAL CHARACTERISTICS (continued)

$V_{IN1} = 12V$, $V_{IN2} = 5V$, $T_A = 25^\circ C$, unless otherwise noted.

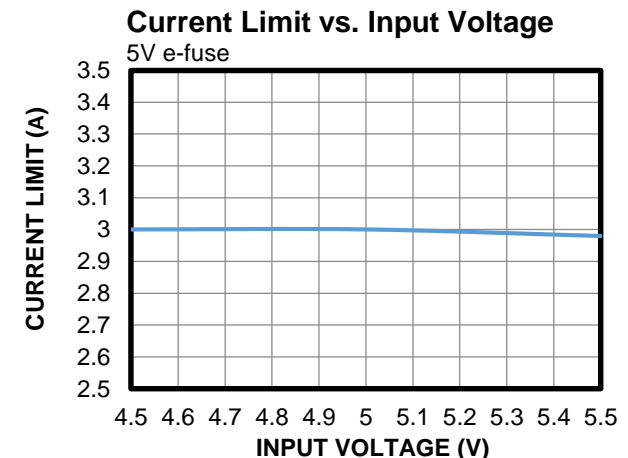
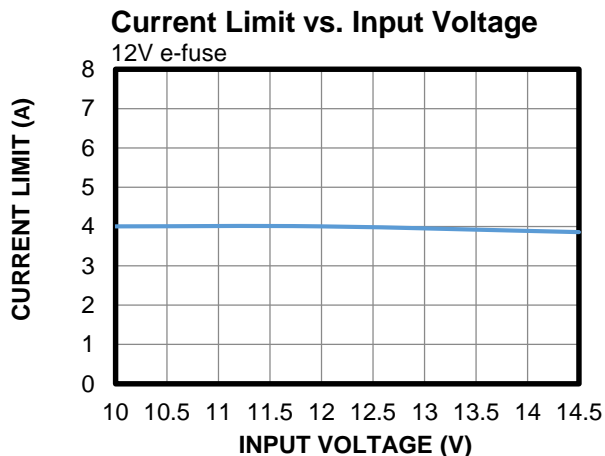
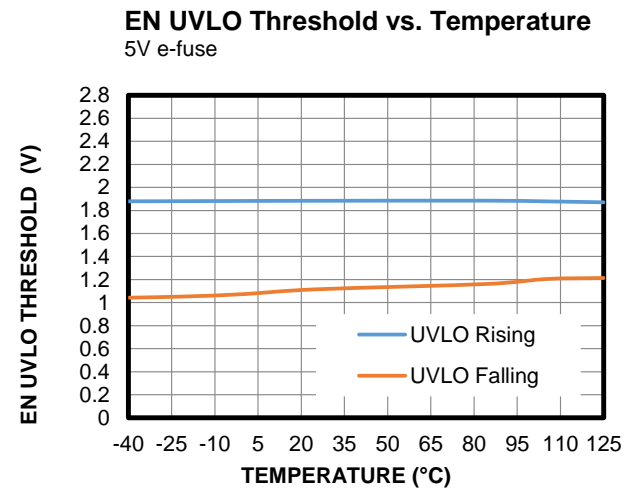
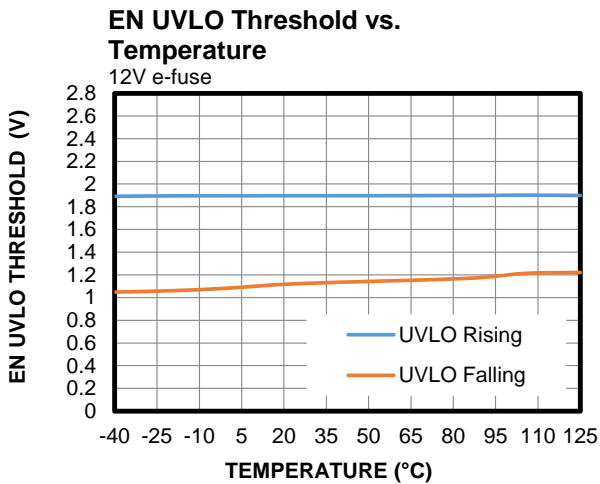
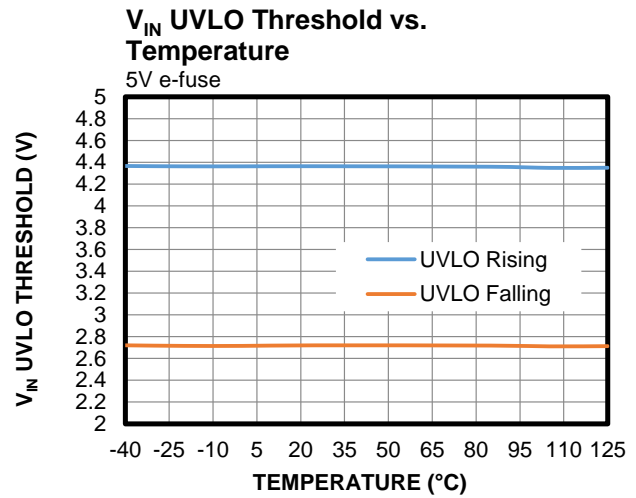
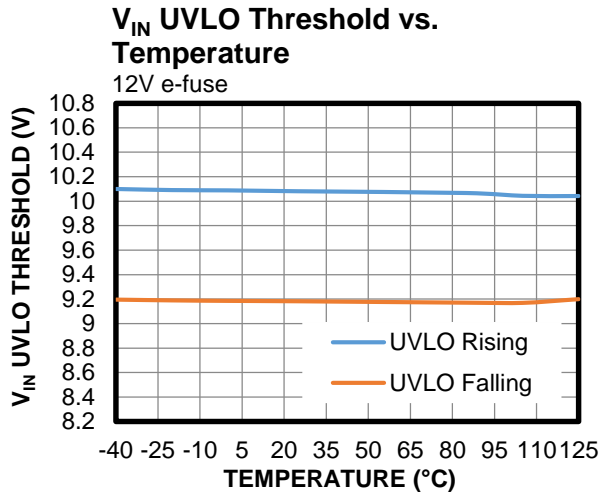

TYPICAL CHARACTERISTICS (continued)

$V_{IN1} = 12V$, $V_{IN2} = 5V$, $T_A = 25^\circ C$, unless otherwise noted.

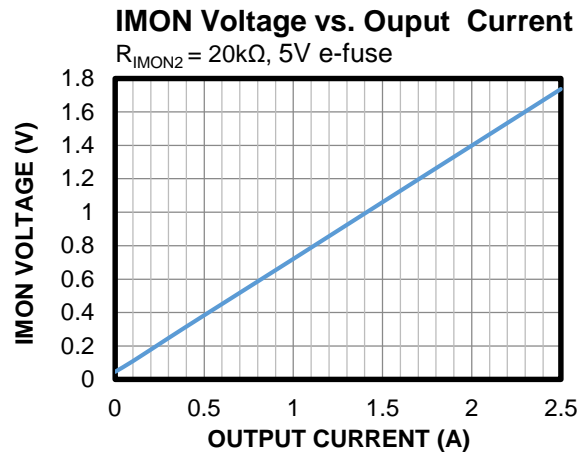
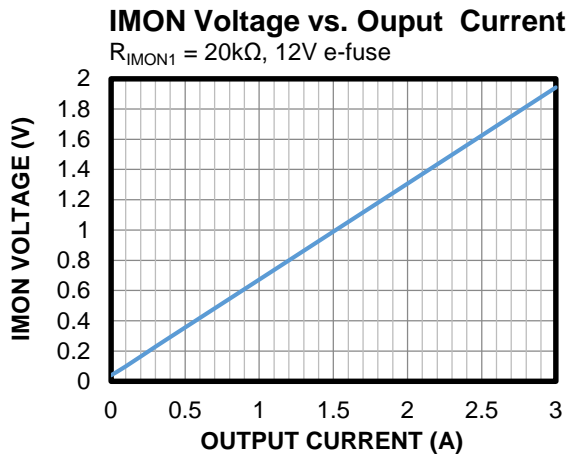
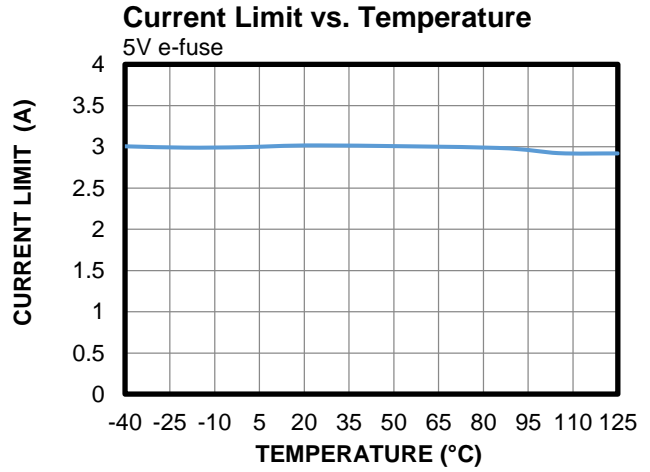
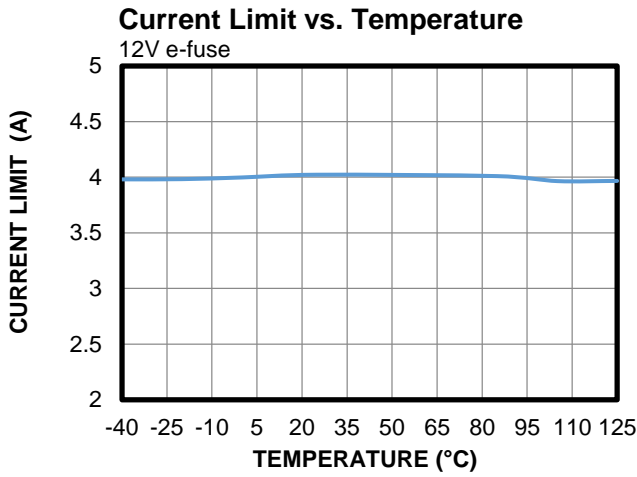

TYPICAL PERFORMANCE CHARACTERISTICS

$V_{IN1} = 12V$, $V_{IN2} = 5V$, $T_A = 25^\circ C$, unless otherwise noted.

CH1/CH2 Start-Up through EN

$I_{OUT1} = I_{OUT2} = 0A$

REF1: V_{EN}

CH2: V_{OUT1}

CH1: V_{OUT2}

CH3: I_{OUT1}

CH4: I_{OUT2}

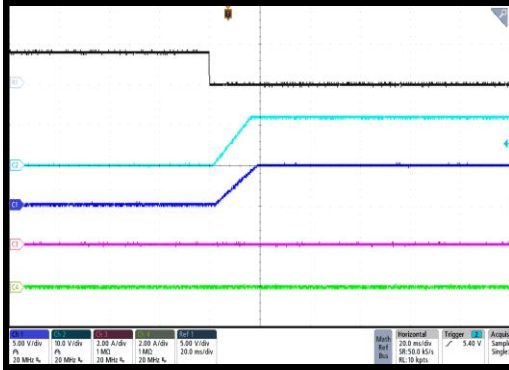

CH1/CH2 Start-Up through EN

$I_{OUT1} = 3A$, $I_{OUT2} = 2A$

REF1: V_{EN}

CH2: V_{OUT1}

CH1: V_{OUT2}

CH3: I_{OUT1}

CH4: I_{OUT2}

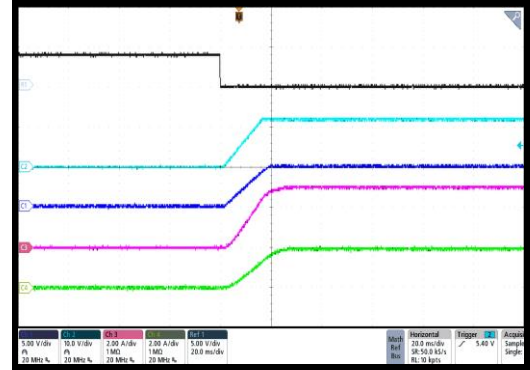

CH1/CH2 Shutdown through EN

$I_{OUT1} = I_{OUT2} = 0A$

REF1: V_{EN}

CH2: V_{OUT1}

CH1: V_{OUT2}

CH3: I_{OUT1}

CH4: I_{OUT2}

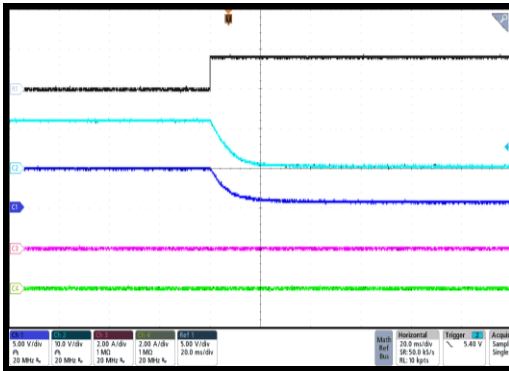

CH1/CH2 Shutdown through EN

$I_{OUT1} = 3A$, $I_{OUT2} = 2A$

REF1: V_{EN}

CH2: V_{OUT1}

CH1: V_{OUT2}

CH3: I_{OUT1}

CH4: I_{OUT2}

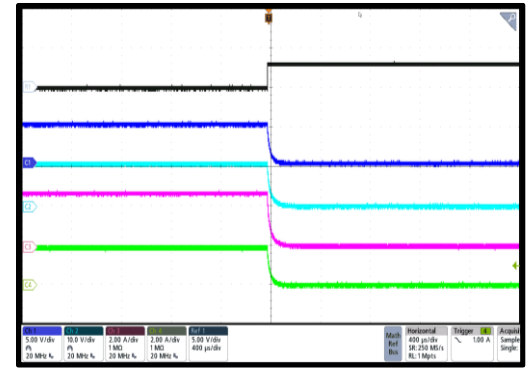

Start-Up through VIN1

12V e-fuse, no load

CH1: V_{OUT1}

CH2: V_{IN1}

CH3: V_{IMON1}

CH4: I_{OUT1}

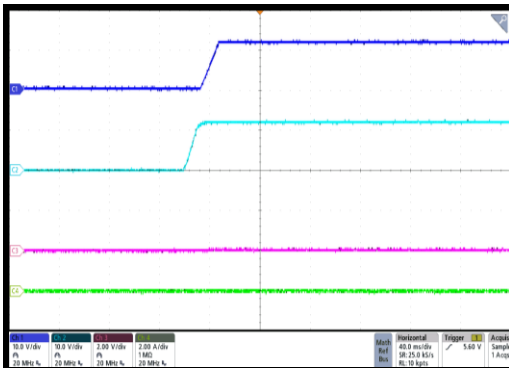

Shutdown through VIN1

12V e-fuse, no load

CH1: V_{OUT1}

CH2: V_{IN1}

CH3: V_{IMON1}

CH4: I_{OUT1}

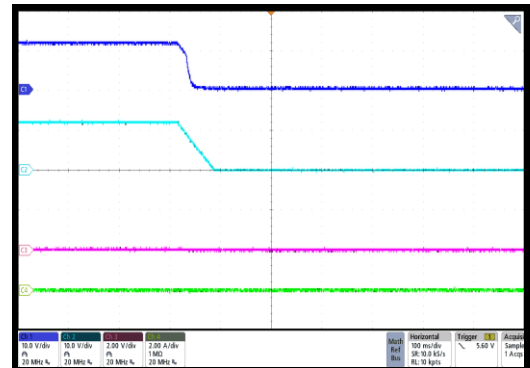

TYPICAL PERFORMANCE CHARACTERISTICS (continued)
 $V_{IN1} = 12V$, $V_{IN2} = 5V$, $T_A = 25^\circ C$, unless otherwise noted.

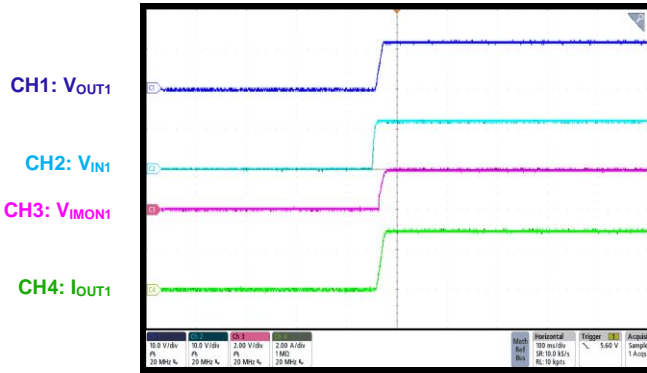
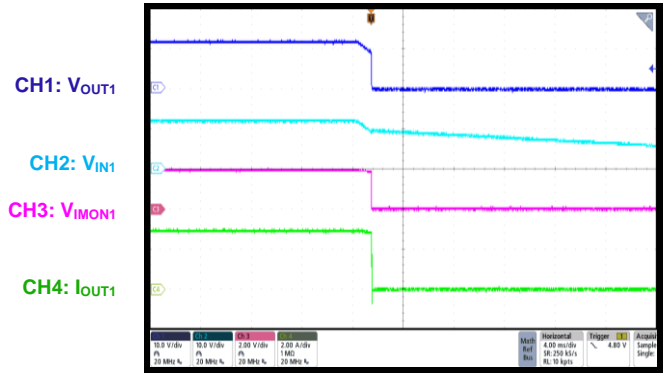
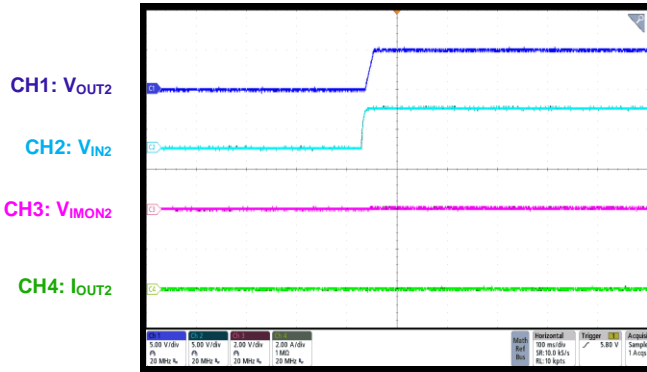
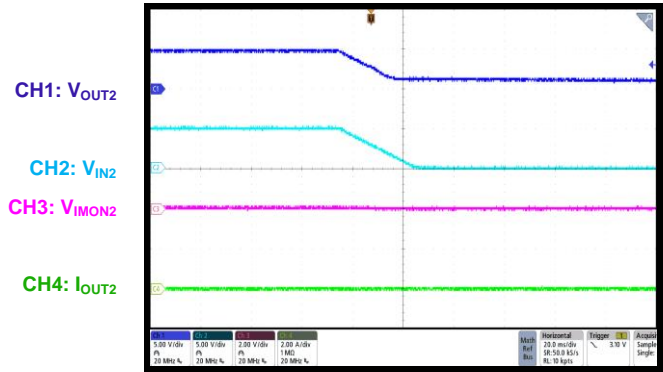
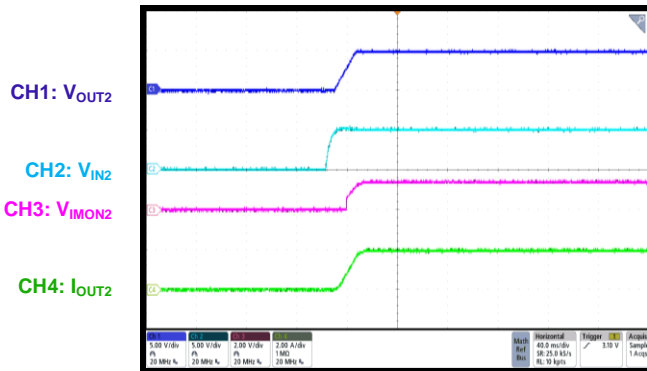
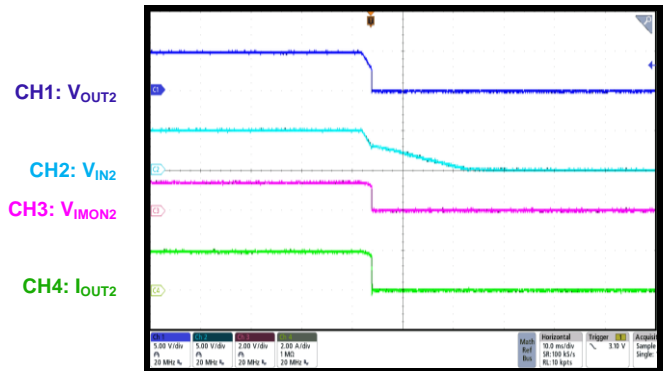
Start-Up through VIN1
 12V e-fuse, 3A load

Shutdown through VIN1
 12V e-fuse, 3A load

Start-Up through VIN2
 5V e-fuse, no load

Shutdown through VIN2
 5V e-fuse, no load

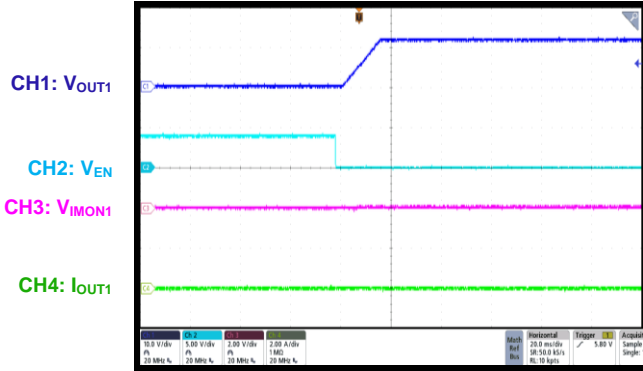
Start-Up through VIN2
 5V e-fuse, 2A load

Shutdown through VIN2
 5V e-fuse, 2A load

TYPICAL PERFORMANCE CHARACTERISTICS (continued)

$V_{IN1} = 12V$, $V_{IN2} = 5V$, $T_A = 25^\circ C$, unless otherwise noted.

Start-Up through EN
12V e-fuse, no load



Shutdown through EN
12V e-fuse, no load

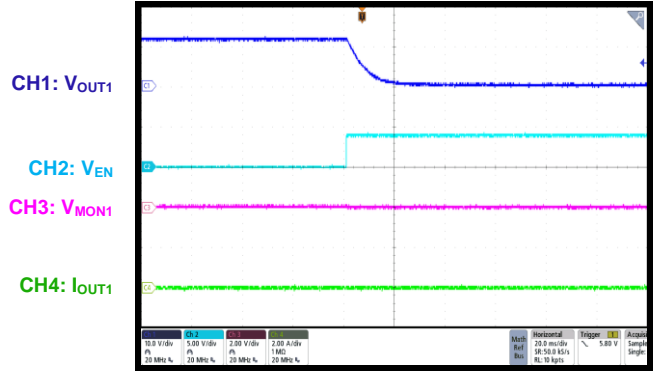

Start-Up through EN
12V e-fuse, 3A load

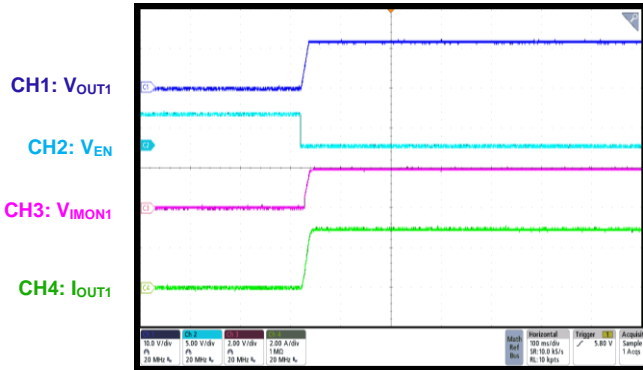

Shutdown through EN
12V e-fuse, 3A load

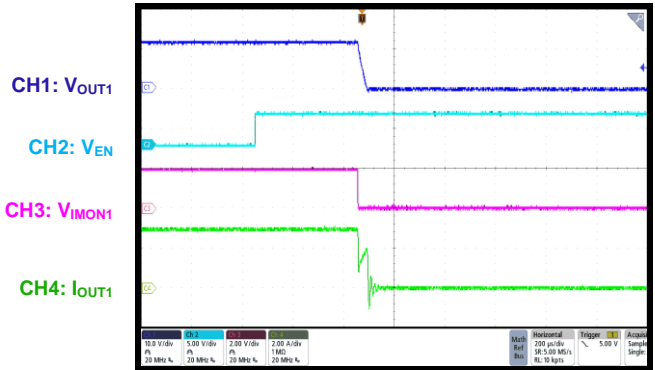

Start-Up through EN
5V e-fuse, no load

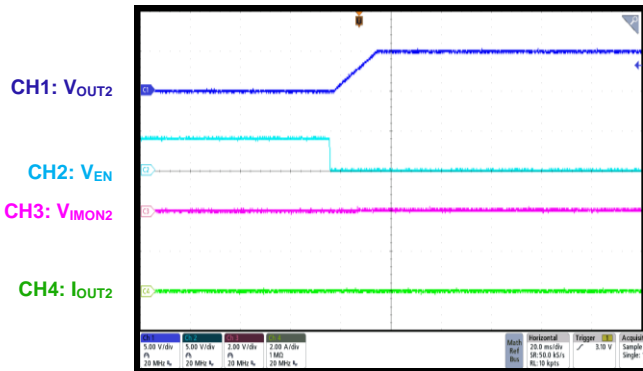

Shutdown through EN
5V e-fuse, no load

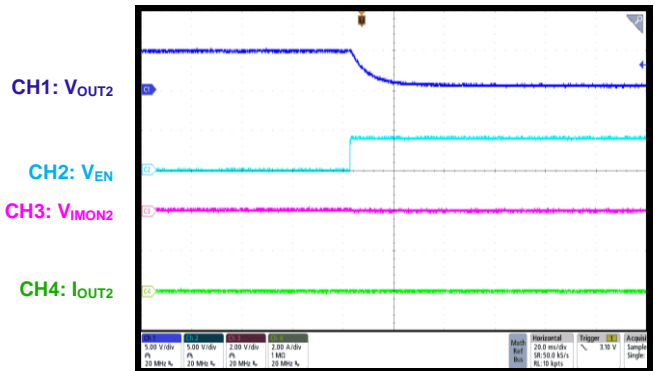

TYPICAL PERFORMANCE CHARACTERISTICS (continued)

$V_{IN1} = 12V$, $V_{IN2} = 5V$, $T_A = 25^\circ C$, unless otherwise noted.

Start-Up through EN
5V e-fuse, 2A load

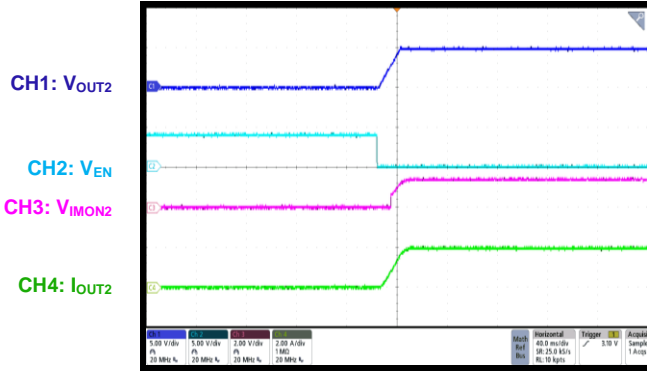

Shutdown through EN
5V e-fuse, 2A load

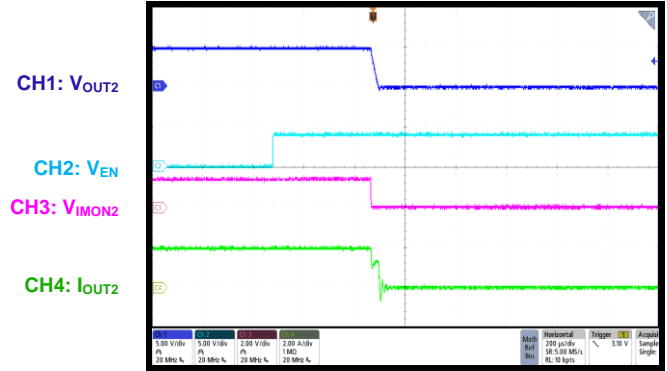

Current Limit
12V e-fuse, I_{OUT} increases slowly

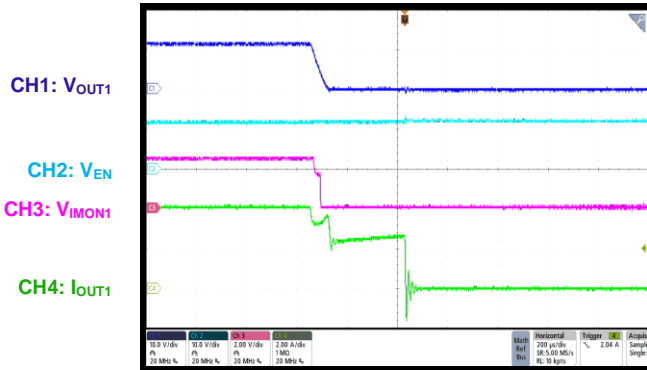

Current Limit
5V e-fuse, I_{OUT} increases slowly

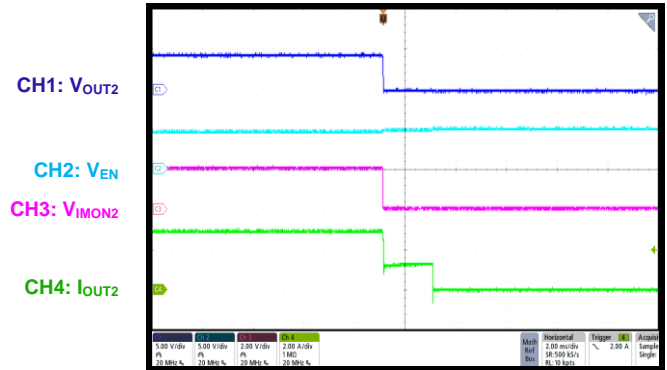

SCP Entry
12V e-fuse

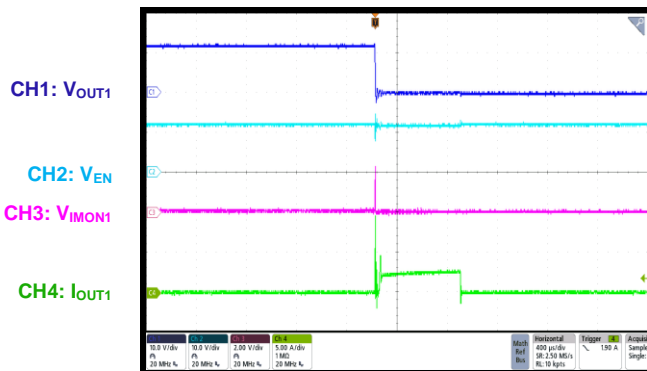

SCP Entry
5V e-fuse

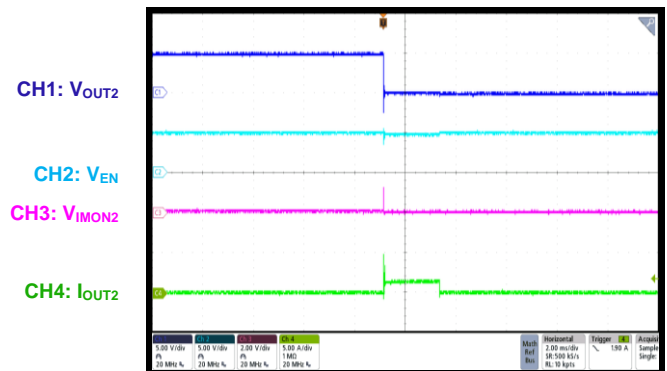

TYPICAL PERFORMANCE CHARACTERISTICS (continued)

$V_{IN1} = 12V$, $V_{IN2} = 5V$, $T_A = 25^\circ C$, unless otherwise noted.

SCP Recovery
12V e-fuse

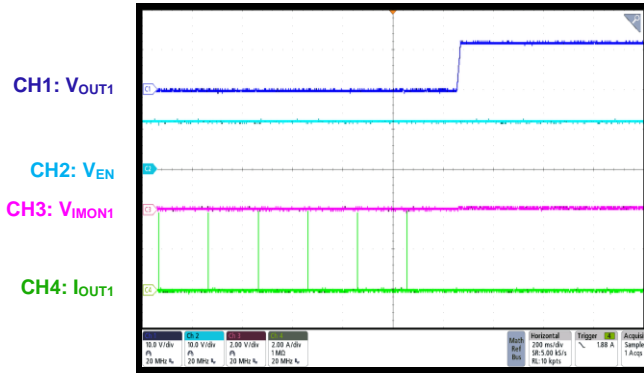

SCP Recovery
5V e-fuse

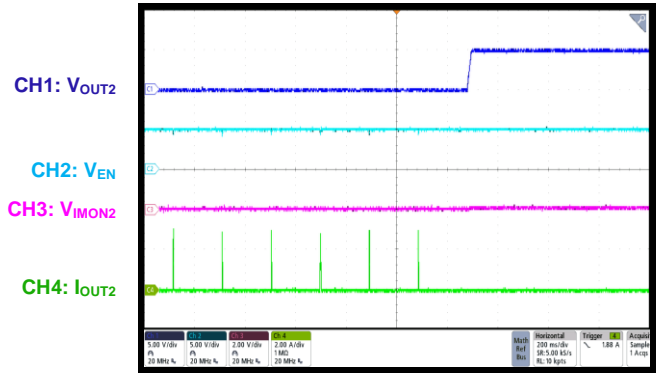

Output OVP
12V e-fuse, $V_{IN1} = 12V$ to $18V$

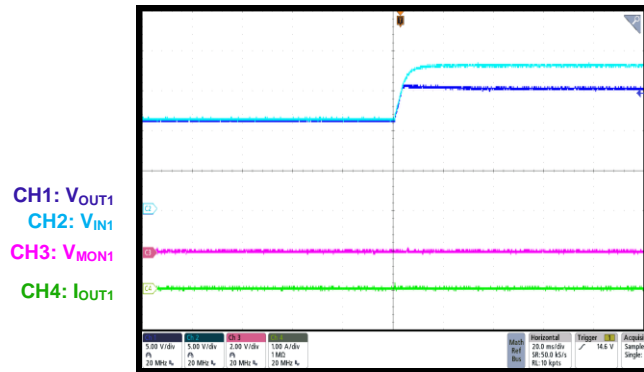

Output OVP
5V e-fuse, $V_{IN2} = 5V$ to $7V$

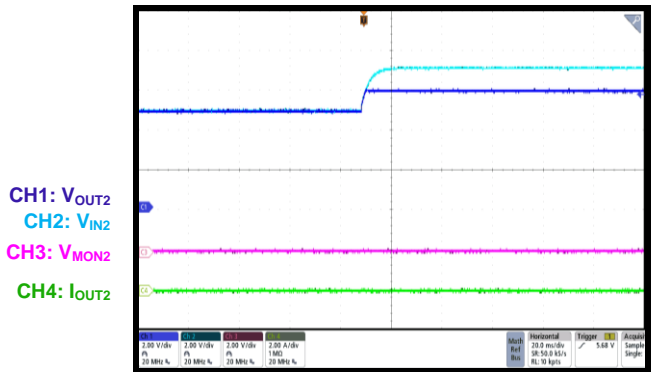

FUNCTIONAL BLOCK DIAGRAM

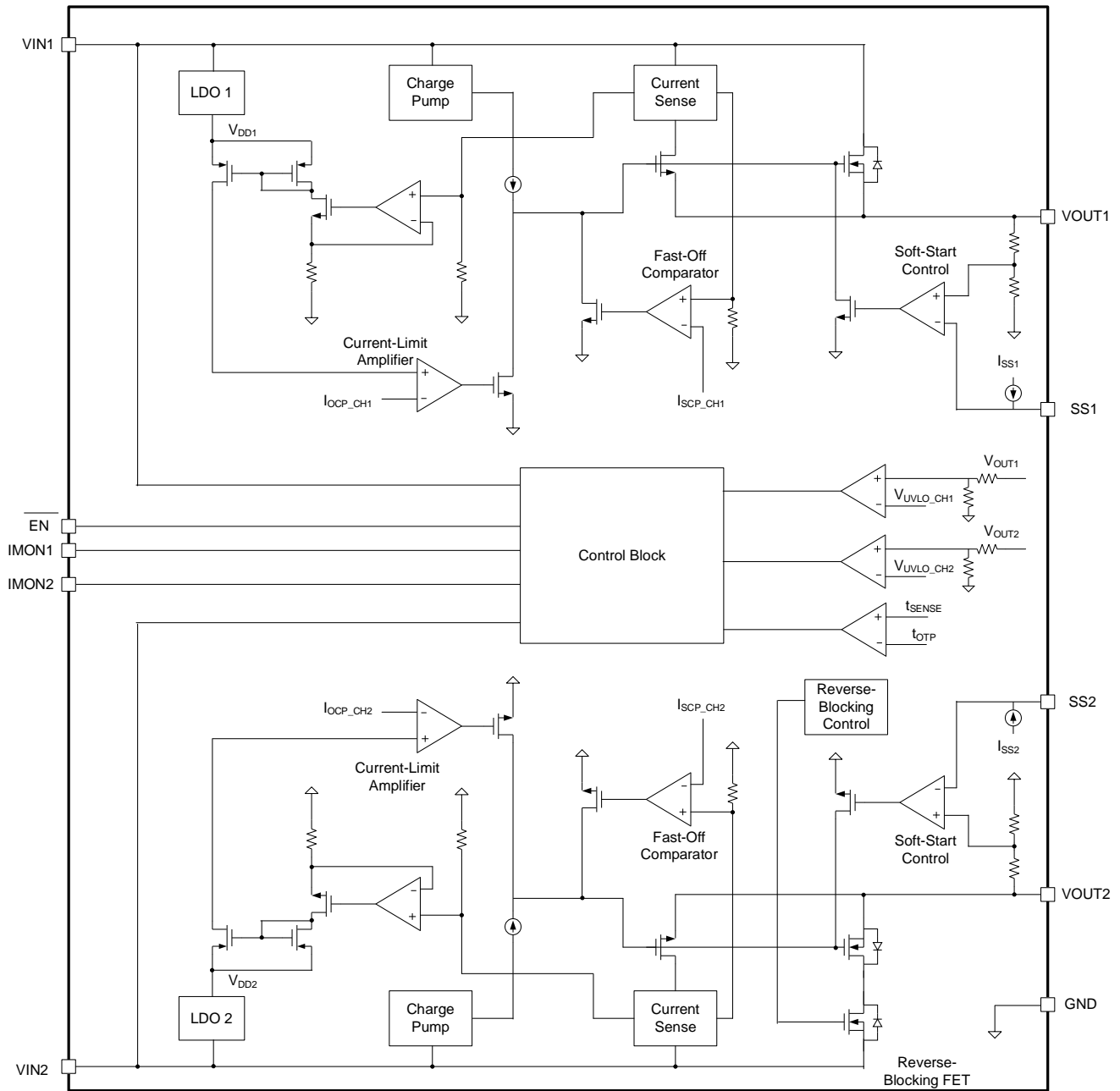

Figure 1: Functional Block Diagram

OPERATION

The MP5098 is a 12V/5V, dual-channel e-fuse with current limiting. It is designed to limit the inrush current to the load while a circuit card is inserted into a live backplane power source. This limits the backplane's voltage drop and the dV/dt to the load. The MP5098 offers an integrated solution that can monitor the input voltage (V_{IN}), output voltage (V_{OUT}), output current (I_{OUT}), and die temperature. This eliminates the need for an external current-sense resistor, power MOSFET, and thermal-sensing device.

Under-Voltage Lockout (UVLO) Protection

Channel 1 can be used in the 12V system, and channel 2 can be used in the 5V system. High energy transients can occur during normal operation or hot swap. These transients are determined by the wire's parasitic inductance and resistance, as well as the VCC capacitor (C_{VCC}). If a power-clamped TVS diode is not used, then the e-fuse should be able to withstand the transient voltage. The MP5098 integrates a high-voltage MOSFET and a high-voltage circuit at VCC to guarantee safe operation.

If V_{IN} drops below the under-voltage lockout (UVLO) threshold, then the output is disabled. Once V_{IN} exceeds the UVLO threshold, the output is enabled.

Soft Start (SS)

Connect a capacitor to the SS pin to set the soft-start time (t_{SS}). t_{SS} is a function of the soft-start capacitor (C_{SS}). A constant-current source charges C_{SS} , and the SS voltage (V_{SS}) ramps up. V_{OUT} ramps up at a similar slew rate to V_{SS} .

t_{SS} can be calculated with Equation (1):

$$t_{DV/DT}(\text{ms}) = \frac{1V \times C_{SS}(\text{nF})}{I_{SS}} \quad (1)$$

Where $t_{DV/DT}$ is t_{SS} between 0% and 100% of V_{OUT} , and I_{SS} is the soft-start current.

Output Over-Voltage Protection (OVP)

The MP5098 provides output over-voltage protection (OVP) to protect the downstream load from surge voltages at the input. An accurate, fast comparator monitors V_{OUT} . If V_{OUT}

exceeds the OVP threshold, then the gate voltage (V_{GATE}) of the internal MOSFETs is pulled down. V_{GATE} is regulated at a certain value to keep V_{OUT} clamped at the OVP threshold. Fast loop response speed (typically 2 μ s) reduces the over-voltage (OV) overshoot.

Over-Current Protection (OCP)

If an over-current (OC) fault occurs (e.g. the load exceeds the current limit [I_{LIMIT_CHx}] or a short occurs), then over-current protection (OCP) is triggered and the part enters constant-current mode. If the OC condition remains after 150 μ s, then the part enters hiccup mode and shuts down. After a 200ms off time (t_{OFF}), the part starts up again. The MP5098 repeats this operation until the OC condition has been removed.

Channel 1's current limit (I_{LIMIT_CH1}) is set at 4A internally, and its constant-current limit ($I_{LIMIT_CC_CH1}$) is set at 2.5A. Channel 2's current limit (I_{LIMIT_CH2}) is set at 3A internally, and its constant-current limit ($I_{LIMIT_CC_CH2}$) is set at 1.3A.

Current Monitoring

The MP5098 provides current monitoring for both channel 1 and channel 2. The IMONx pin generates a current proportional to channel 1 and channel 2's load current (I_{LOAD_CHx}). Connect a resistor to IMONx to generate the current monitor voltage (V_{IMONx}). The effective V_{IMONx} range is between 0V and 2.5V to guarantee that the sensing results are linear. V_{IMONx} can be calculated with Equation (2):

$$V_{IMONx}(\text{mV}) = G_{IMONx} \times I_{OUT}(\text{A}) \times R_{IMONx}(\text{k}\Omega) + I_{OFFSET_CHx} \times R_{IMONx}(\text{k}\Omega) \quad (2)$$

Where G_{IMON_CHx} is the current-sense gain, R_{IMON_CHx} is the current-sense resistor, and I_{OFFSET_CHx} is the current-sense offset.

Short Circuit Protection (SCP)

If the I_{LOAD_CHx} increases rapidly due to a short circuit, the current may exceed I_{LIMIT_CHx} before the control loop can respond. If the current reaches the secondary I_{LIMIT} level (8A), then short-circuit protection (SCP) is triggered and the fast turn-off circuit turn offs the MOSFET (see Figure 1 on page 15). This limits the peak current through the MOSFET to maintain V_{IN} . The total short-circuit response time is less than

1 μ s. Once the e-fuse turns off, the part starts up after a delay (200ms). If the short still remains, then V_{GATE} is regulated to maintain the current at its I_{LIMIT} level, and the part enters hiccup mode after a 200ms off time (t_{OFF}). The MP5098 repeats this operation until the short circuit has been removed.

Enable

\overline{EN} is a digital control pin that enables and disabled the current-limit MOSFET. Pull \overline{EN} low

or float \overline{EN} to turn the current-limit MOSFET on; pull \overline{EN} high to turn it off. An internal 770k Ω resistor connected between \overline{EN} and GND allows \overline{EN} to float to start up the device.

Thermal Shutdown

Thermal shutdown monitors the silicon die temperature to prevent the chip from operating at exceedingly high temperatures. If the temperature exceeds 155°C, then the part shuts down.

APPLICATION INFORMATION

Setting the Soft-Start Time (t_{SS})

The soft-start time (t_{SS}) is a function of the soft-start capacitor (C_{SS}). t_{SS} can be calculated with Equation (3):

$$t_{DV/DT}(\text{ms}) = \frac{1V \times C_{SS}(\text{nF})}{I_{SS}} \quad (3)$$

Where $t_{DV/DT}$ is t_{SS} between 0% and 100% of V_{OUT} .

Design Example

Table 1 shows a design example following the application guidelines for the specifications.

Table 1: Design Example

V_{IN1}	12V
V_{OUT1}	12V
V_{IN2}	5V
V_{OUT2}	5V

Figure 3 on page 19 shows the detailed application schematic. The typical performance and waveforms are shown in the Typical Characteristics section on page 7 and the Typical Performance Characteristics section on page 10. For more device applications, refer to the related evaluation board datasheet.

PCB Layout Guidelines

Efficient PCB layout is critical for stable operation. For best results, refer to Figure 2 and follow the guidelines below:

1. Place the high-current paths (V_{IN} and V_{OUT}) close to the device using short, direct, and wide traces.
2. Place the input capacitors as close to the V_{IN} and GND pins as possible.
3. To improve thermal performance, connect the V_{IN} pad to the large V_{IN} plane, and the V_{OUT} pad to the large V_{OUT} plane.
4. Place C_{SS} as close to SS pin as possible.

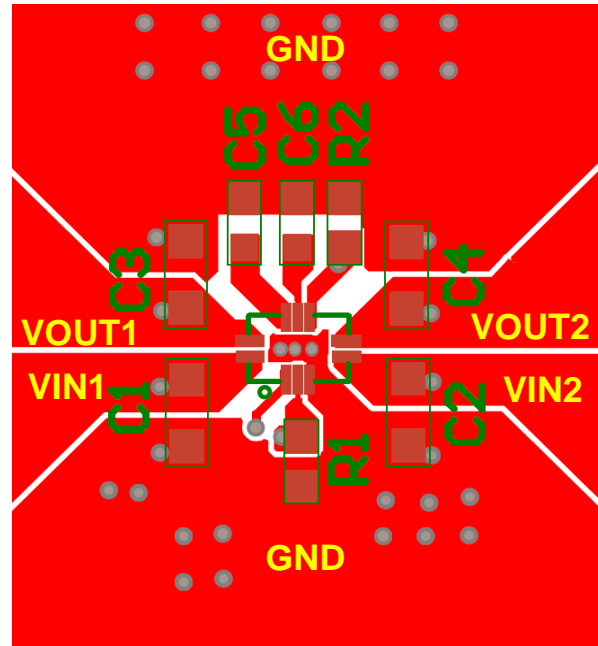

Figure 2: Recommended PCB Layout

TYPICAL APPLICATION CIRCUIT

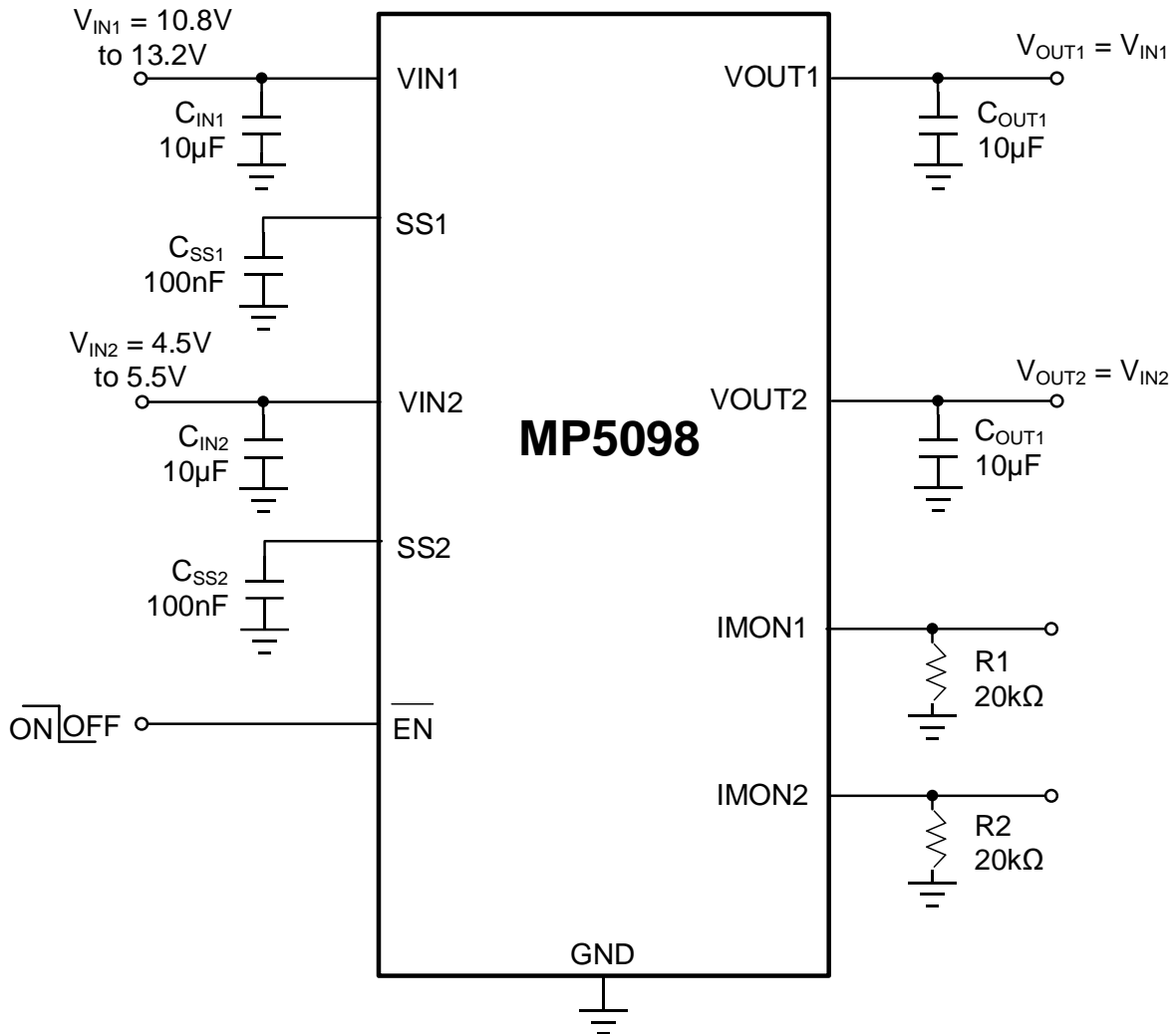
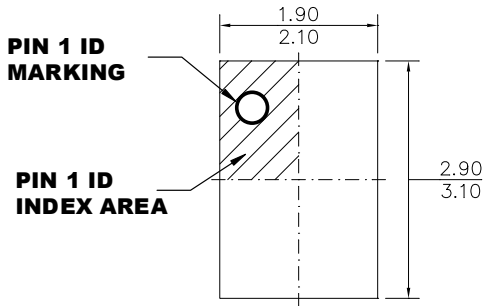

Figure 3: Typical Application Circuit

PACKAGE INFORMATION

TQFN-10 (2mmx3mm)



TOP VIEW

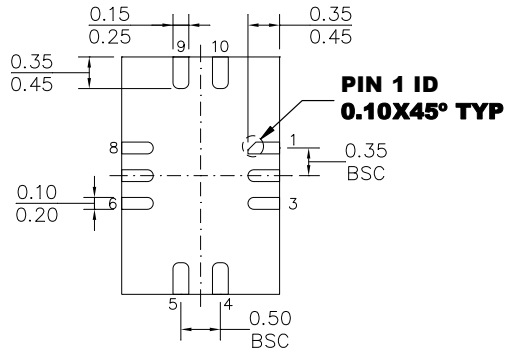

BOTTOM VIEW

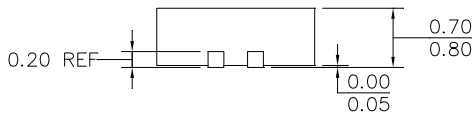

SIDE VIEW

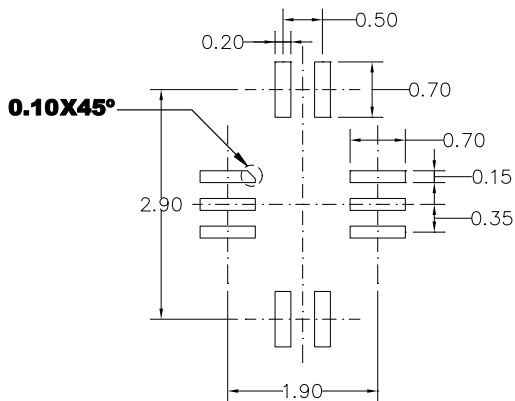

RECOMMENDED LAND PATTERN

NOTE:

- 1) ALL DIMENSIONS ARE IN MILLIMETERS.
- 2) LEAD COPLANARITIES SHALL BE 0.08 MILLIMETERS MAX.
- 3) JEDEC REFERENCE IS MO-220.
- 4) DRAWING IS NOT TO SCALE.

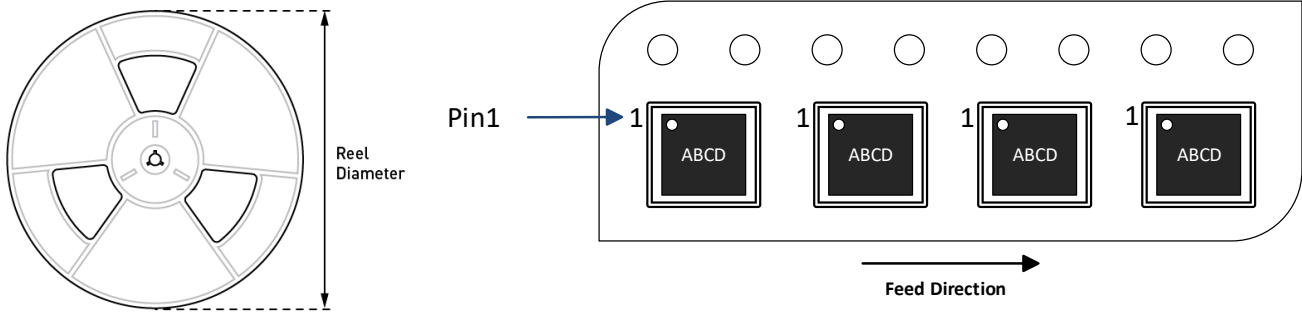
CARRIER INFORMATION

Part Number	Package Description	Quantity/ Reel	Quantity/ Tube	Quantity/ Tray	Reel Diameter	Carrier Tape Width	Carrier Tape Pitch
MP5098GDT-Z	TQFN-10 (2mmx3mm)	5000	N/A	N/A	13in	12mm	8mm