

### DESCRIPTION

The MP6619L is an H-bridge motor driver. It operates from a supply input voltage ( $V_{IN}$ ) up to 28V and delivers a motor current up to 5A. The MP6619L is ideally suited to drive a brushed DC motor.

The MP6619L also has a configurable current limit. Full protection features include over-current protection (OCP),  $V_{IN}$  over-voltage protection (OVP),  $V_{CC}$  under-voltage lockout (UVLO), and thermal shutdown.

The MP6619L is available in a QFN-19 (3mmx3mm) package.

### FEATURES

- Wide 2.5V to 28V Operating Input Voltage ( $V_{IN}$ ) Range
- Up to 5A Peak Output Current ( $I_{OUT}$ )
- Compliance with 3.3V and 5V Systems
- Internal H-Bridge Driver
- Configurable Current Limit
- 65m $\Omega$  On Resistance ( $R_{DS(ON)}$ ) for Each Half-Bridge MOSFET with 5V  $V_{CC}$
- 100% Duty Cycle Operation of H-Bridge
- 1 $\mu$ A Shutdown Mode
- Over-Current Protection (OCP)
- $V_{IN}$  Over-Voltage Protection (OVP)
- $V_{CC}$  Under-Voltage Lockout (UVLO)
- Over-Temperature (OT) Shutdown
- Fault Indication Output
- Available in a QFN-19 (3mmx3mm) Package

### APPLICATIONS

- DC Motors
- Solenoids and Actuators

All MPS parts are lead-free, halogen-free, and adhere to the RoHS directive. For MPS green status, please visit the MPS website under Quality Assurance. "MPS", the MPS logo, and "Simple, Easy Solutions" are trademarks of Monolithic Power Systems, Inc. or its subsidiaries.

### TYPICAL APPLICATION

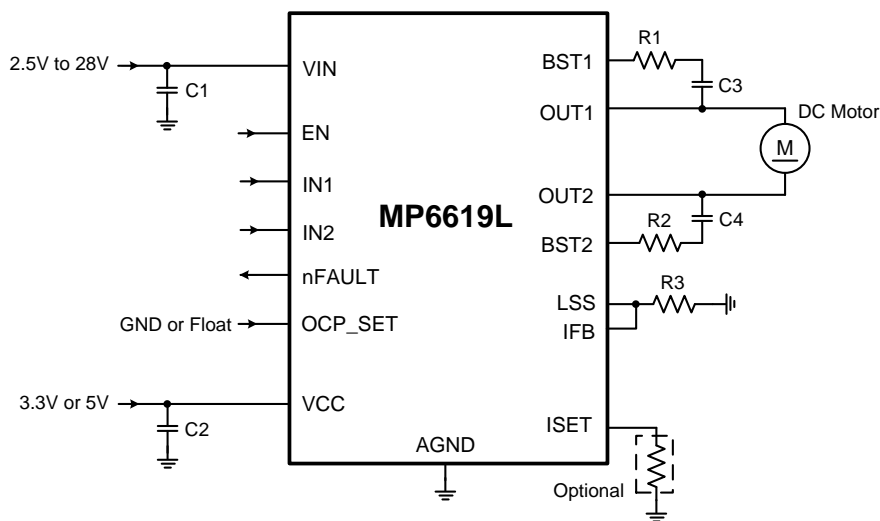

### ORDERING INFORMATION

Part Number*	Package	Top Marking	MSL Rating
MP6619LGQ	QFN-19 (3mmx3mm)	See Below	1

\* For Tape & Reel, add suffix -Z (e.g. MP6619LGQ-Z).

### TOP MARKING

          
**BVNY**  
**LLLL**

BVN: Product code of MP6619LGQ

Y: Year code

LLLL: Lot number

### PACKAGE REFERENCE

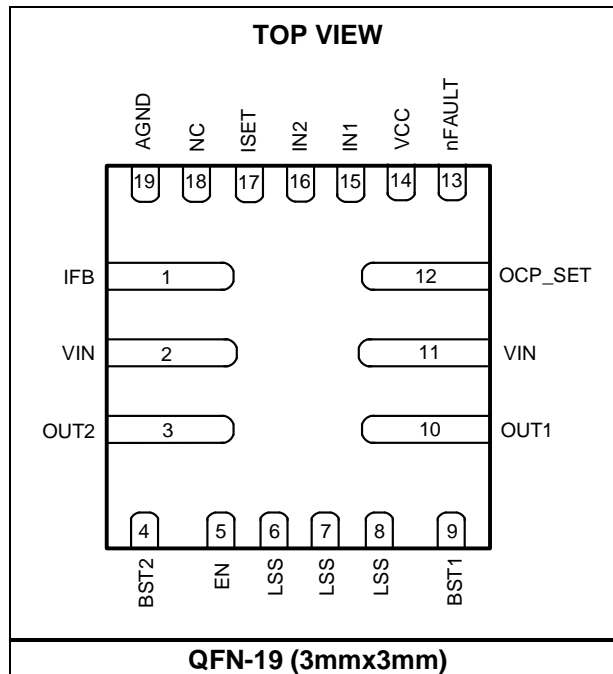

## PIN FUNCTIONS

Pin #	Name	Description
1	IFB	<b>Current-sense signal feedback.</b> Connect the IFB pin to LSS.
2, 11	VIN	<b>Input supply for motor driver.</b>
3	OUT2	<b>Output terminal 2.</b>
4	BST2	<b>Bootstrap (BST) pin for the OUT2 high-side MOSFET (HS-FET) gate driver.</b> Connect a capacitor between the BST2 and OUT2 pins.
5	EN	<b>IC enable.</b> Pull down the EN pin internally.
6, 7, 8	LSS	<b>Low-side (LS) source connection.</b> For current sense, connect a current-sense resistor between the LSS pin and power ground.
9	BST1	<b>BST pin for the OUT1 HS-FET gate driver.</b> Connect a capacitor between the BST1 and OUT1 pins.
10	OUT1	<b>Output terminal 1.</b>
12	OCP_SET	<b>Over-current protection (OCP) setting.</b> Float the OCP_SET pin or connect it to AGND. Float OCP_SET to enable OCP; pull OCP_SET logic low to disable OCP.
18	NC	<b>Not connected.</b> Float the NC pin or connect it to AGND.
13	nFAULT	<b>Fault indication output.</b> Pull the nFAULT pin active low for fault conditions.
14	VCC	<b>Logic supply input for internal driver and logic.</b>
15	IN1	<b>Output 1 control input.</b> Pull the IN1 pin down internally.
16	IN2	<b>Output 2 control input.</b> Pull the IN2 pin down internally.
17	ISET	<b>Current trip voltage setting.</b> Connect a resistor from the ISET pin to ground.
19	AGND	<b>Ground for internal logic.</b>

### ABSOLUTE MAXIMUM RATINGS <sup>(1)</sup>

Supply voltage ( $V_{IN}$ )	36V
Supply voltage ( $V_{CC}$ )	6V
$V_{OUTx}$	-0.3V to $V_{IN} + 0.3V$
$V_{BST1}$	$V_{OUT1} + 6V$
$V_{BST2}$	$V_{OUT2} + 6V$
LSS voltage ( $V_{LSS}$ )	-0.3V to +0.6V
All other pins	-0.3V to +6V
Continuous power dissipation ( $T_A = 25^\circ C$ ) <sup>(2)</sup>	
QFN-19 (3mmx3mm)	2.5W
Junction temperature	150°C
Lead temperature	260°C
Storage temperature	-65°C to +150°C

### ESD Ratings

Human body model (HBM)	±2kV
Charged device model (CDM)	±2kV

### Recommended Operating Conditions <sup>(3)</sup>

Supply voltage ( $V_{IN}$ )	2.5V to 28V
Supply voltage ( $V_{CC}$ )	2.8V <sup>(4)</sup> to 5.5V
Operating junction temp ( $T_J$ )	-40°C to +125°C

<b>Thermal Resistance <sup>(5)</sup></b>	<b><math>\theta_{JA}</math></b>	<b><math>\theta_{JC}</math></b>
QFN-19 (3mmx3mm)	50.....	12... °C/W

#### Notes:

- Exceeding these ratings may damage the device.
- The maximum allowable power dissipation is a function of the maximum junction temperature,  $T_J$  (MAX), the junction-to-ambient thermal resistance,  $\theta_{JA}$ , and the ambient temperature,  $T_A$ . The maximum allowable continuous power dissipation at any ambient temperature is calculated by  $P_D$  (MAX) =  $(T_J$  (MAX) -  $T_A$ ) /  $\theta_{JA}$ . Exceeding the maximum allowable power dissipation can produce an excessive die temperature, which may cause the regulator to go into thermal shutdown. Internal thermal shutdown circuitry protects the device from permanent damage.
- The device is not guaranteed to function outside of its operation conditions.
- 2.8V is the minimum VCC operating voltage when  $V_{CC}$  is falling.
- Measured on JESD51-7, a 4-layer PCB.

## ELECTRICAL CHARACTERISTICS

$V_{IN} = 24V$ ,  $V_{CC} = 3.3V$ ,  $T_A = 25^\circ C$ , unless otherwise noted.

Parameters	Symbol	Condition	Min	Typ	Max	Units
<b>Supply Voltage</b>						
V <sub>IN</sub> operating range	V <sub>IN</sub>		2.5		28	V
V <sub>CC</sub> operating range	V <sub>CC</sub>	After start-up	2.8	3.3	5.5	V
V <sub>CC</sub> start-up threshold (under-voltage lockout, UVLO)	V <sub>CC_ON</sub>	V <sub>CC</sub> rising edge	2.7	2.9	3.1	V
		V <sub>CC</sub> falling edge	2.4	2.6	2.8	V
Start-up hysteretic voltage	V <sub>CC_HY</sub>			0.3		V
<b>IC Supply</b>						
V <sub>CC</sub> shutdown current	I <sub>VCC_SD</sub>	EN = 0			1	μA
V <sub>CC</sub> quiescent current	I <sub>VCC_SBY</sub>	EN = 1, no load		1.6	2.2	mA
V <sub>IN</sub> quiescent current	I <sub>VIN_SBY</sub>	EN = 1, no load		210	350	μA
<b>Logic</b>						
Logic high threshold	V <sub>IH</sub>				1.5	V
Logic low threshold	V <sub>IL</sub>		0.4			V
Internal pull-down resistance	R <sub>PD</sub>			500		kΩ
IC start-up delay	t <sub>DELAY</sub>	EN active to switching		230	350	μs
<b>Current Control</b>						
Current trip voltage	V <sub>ITRIP</sub>	V <sub>ITRIP</sub> = 200mV	180	200	220	mV
		V <sub>ITRIP</sub> = 100mV	85	100	115	mV
Off time	t <sub>TRIP</sub>	After I <sub>TRIP</sub>		1		ms
<b>Switching Frequency</b>						
Pulse-width modulation (PWM) frequency on IN1 and IN2	f <sub>PWM</sub>				400	kHz
<b>Power MOSFET</b>						
High-side MOSFET (HS-FET) on resistance	R <sub>DSON_HS</sub>	V <sub>CC</sub> = 3.3V, I <sub>OUT</sub> = 500mA	50	78	110	mΩ
		V <sub>CC</sub> = 5V, I <sub>OUT</sub> = 500mA	42	65	93	mΩ
Low-side MOSFET (LS-FET) on resistance	R <sub>DSON_LS</sub>	V <sub>CC</sub> = 3.3V, I <sub>OUT</sub> = 500mA	50	78	110	mΩ
		V <sub>CC</sub> = 5V, I <sub>OUT</sub> = 500mA	42	65	93	mΩ
Minimum on time	t <sub>MIN_ON</sub>			200		ns
<b>Bootstrap (BST) for High-Side (HS) Driver</b>						
Forward voltage for BST charge	V <sub>FBST</sub>			0.5		V
BST UVLO	V <sub>BST_UVLO</sub>	Rising edge		2		V
<b>Protection</b>						
Over-current protection (OCP) retry time	t <sub>OCP</sub>			1		ms
OCP threshold	I <sub>OCP</sub>		5.5	10	18.5	A

**ELECTRICAL CHARACTERISTICS (continued)**
 **$V_{IN} = 24V$ ,  $V_{CC} = 3.3V$ ,  $T_A = 25^{\circ}C$ , unless otherwise noted.**

Parameters	Symbol	Condition	Min	Typ	Max	Units
$V_{IN}$ over-voltage protection (OVP) threshold	$V_{IN\_OVP}$		32.2	34	35.5	V
Thermal shutdown <sup>(6)</sup>	$T_{SD}$			150		$^{\circ}C$
Thermal shutdown hysteresis <sup>(6)</sup>	$T_{SD\_HY}$			20		$^{\circ}C$

**Note:**

6) Not tested in production.

## TYPICAL CHARACTERISTICS

**V<sub>CC</sub> Quiescent Current vs. V<sub>CC</sub>**  
EN = 1, no load

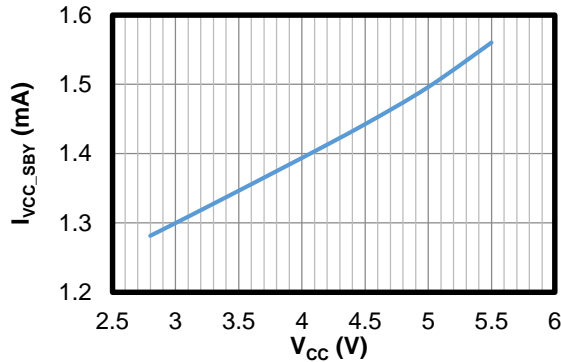

**V<sub>IN</sub> Quiescent Current vs. V<sub>IN</sub>**  
EN = 1, no load

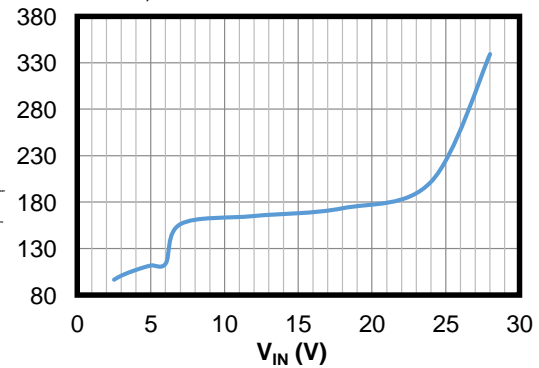

**V<sub>CC</sub> Shutdown Current vs. V<sub>CC</sub>**  
EN = 0, no load

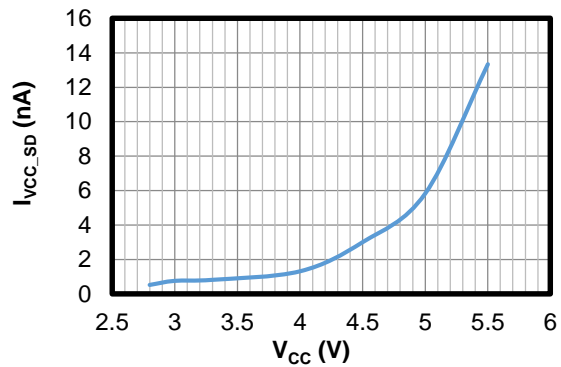

**HS-FET On Resistance vs. V<sub>CC</sub>**  
Output switching

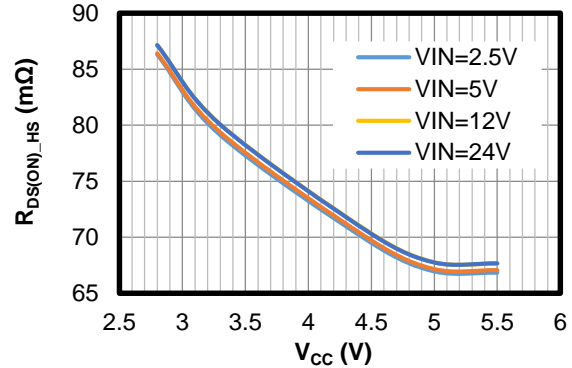

**LS-FET On Resistance vs. V<sub>CC</sub>**

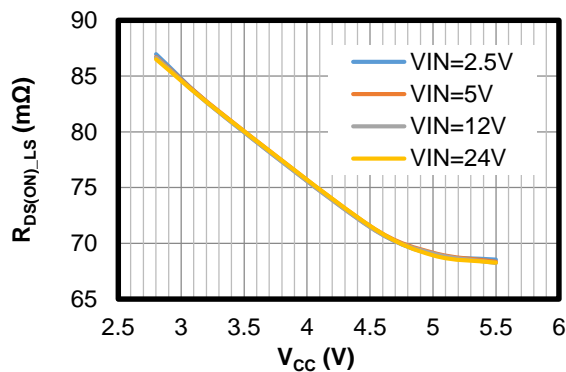

## TYPICAL PERFORMANCE CHARACTERISTICS

$V_{CC} = 3.3V$ ,  $EN = 5V$ ,  $IN1 = 20kHz$ , duty = 50%,  $T_A = 25^\circ C$ , unless otherwise noted.

### Normal Operation

$V_{IN} = 24V$ ,  $IN2 = low$ , load =  $5\Omega + 700\mu H$

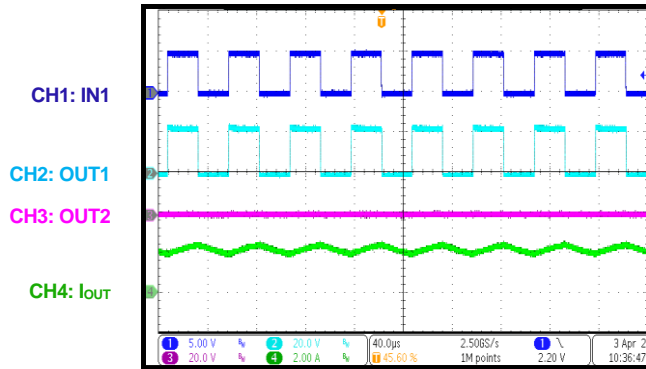

### Normal Operation

$V_{IN} = 24V$ ,  $IN2 = high$ , load =  $5\Omega + 700\mu H$

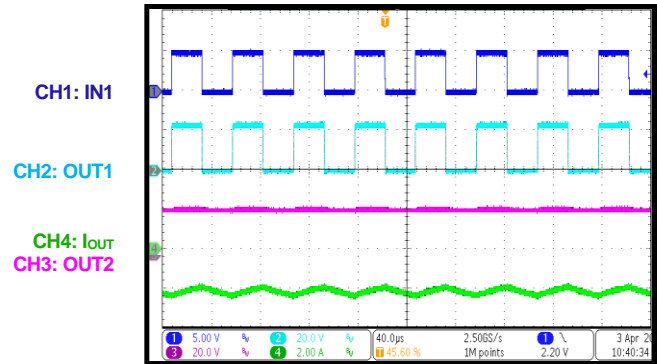

### Normal Operation

$V_{IN} = 5V$ ,  $IN2 = low$ , load =  $2\Omega + 470\mu H$

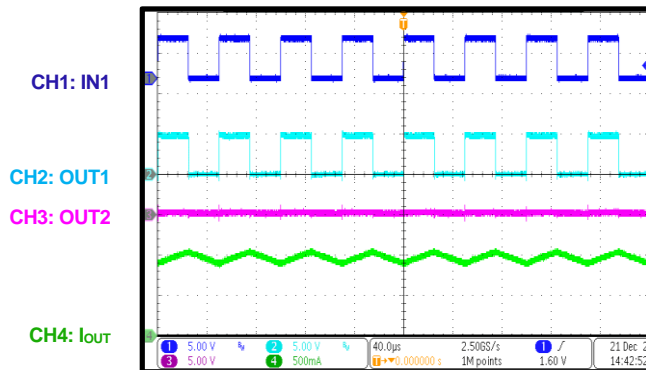

### Normal Operation

$V_{IN} = 5V$ ,  $IN2 = high$ , load =  $2\Omega + 470\mu H$

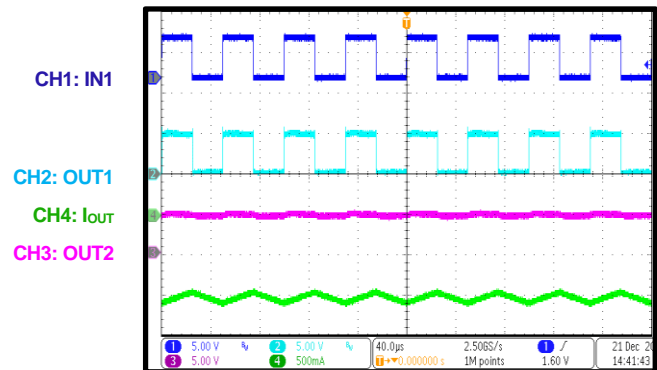

### Start-Up through VIN

$V_{IN} = 24V$ ,  $IN2 = low$ , load =  $5\Omega + 700\mu H$

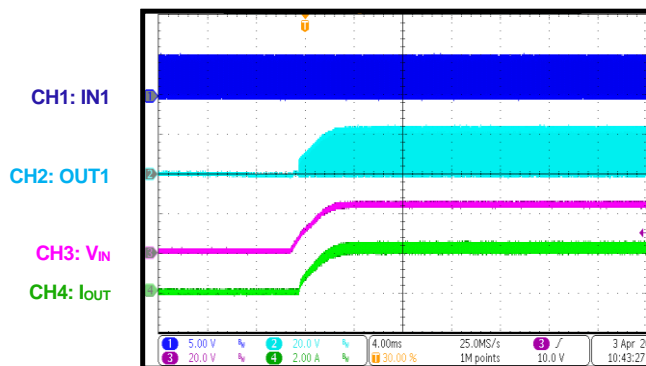

### Start-Up through VIN

$V_{IN} = 24V$ ,  $IN2 = high$ , load =  $5\Omega + 700\mu H$

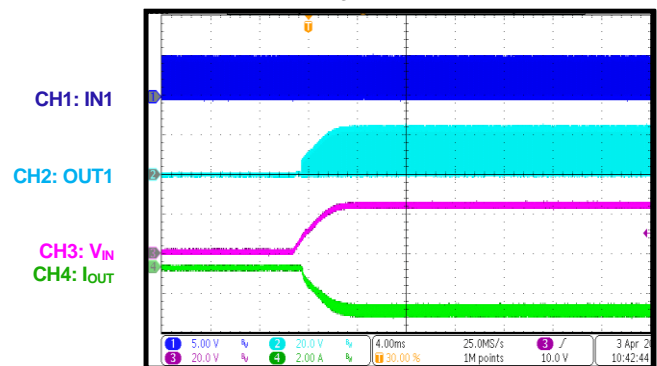

## TYPICAL PERFORMANCE CHARACTERISTICS

$V_{CC} = 3.3V$ ,  $EN = 5V$ ,  $IN1 = 20kHz$ , duty = 50%,  $T_A = 25^\circ C$ , unless otherwise noted.

### Start-Up through VIN

$V_{IN} = 5V$ ,  $IN2 = \text{low}$ , load =  $2\Omega + 470\mu H$

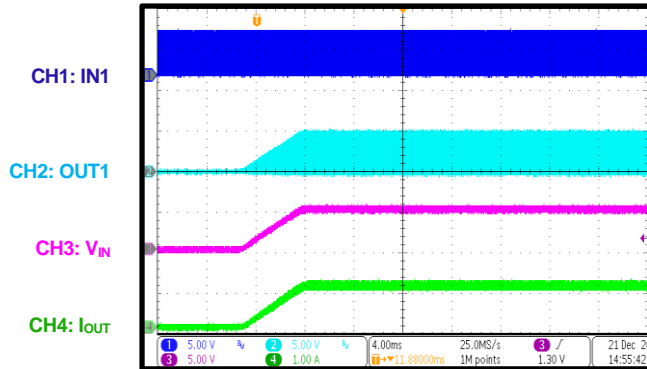

### Start-Up through VIN

$V_{IN} = 5V$ ,  $IN2 = \text{high}$ , load =  $2\Omega + 470\mu H$

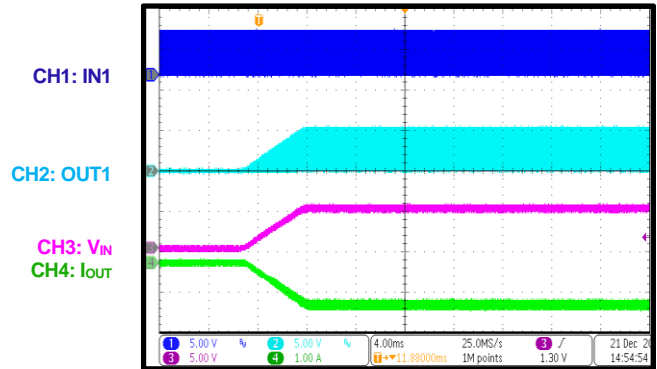

### Shutdown through VIN

$V_{IN} = 24V$ ,  $IN2 = \text{low}$ , load =  $5\Omega + 700\mu H$

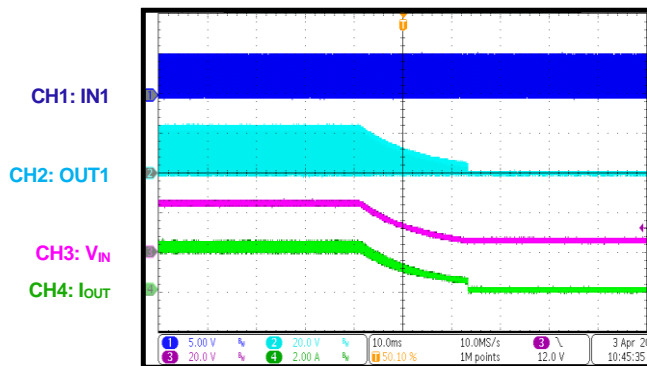

### Shutdown through VIN

$V_{IN} = 24V$ ,  $IN2 = \text{high}$ , load =  $5\Omega + 700\mu H$

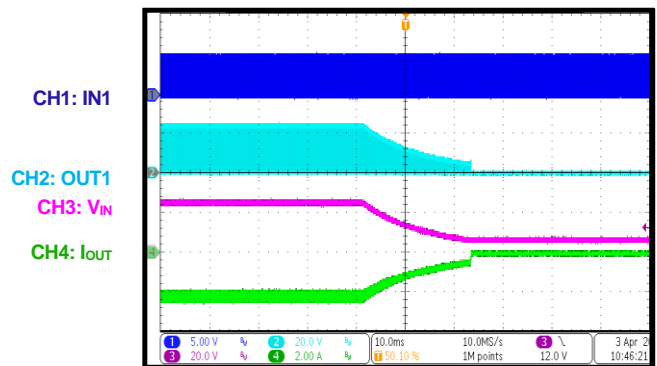

### Shutdown through VIN

$V_{IN} = 5V$ ,  $IN2 = \text{low}$ , load =  $2\Omega + 470\mu H$

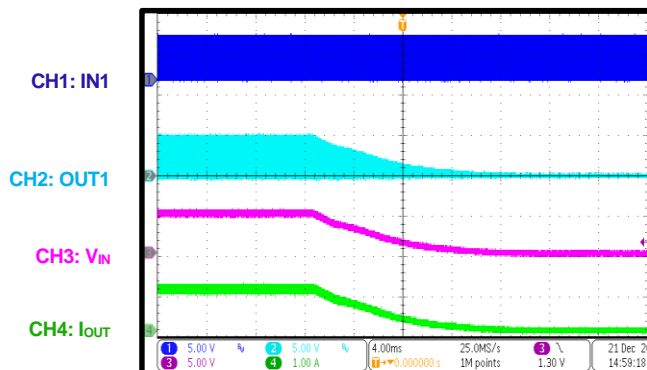

### Shutdown through VIN

$V_{IN} = 5V$ ,  $IN2 = \text{high}$ , load =  $2\Omega + 470\mu H$

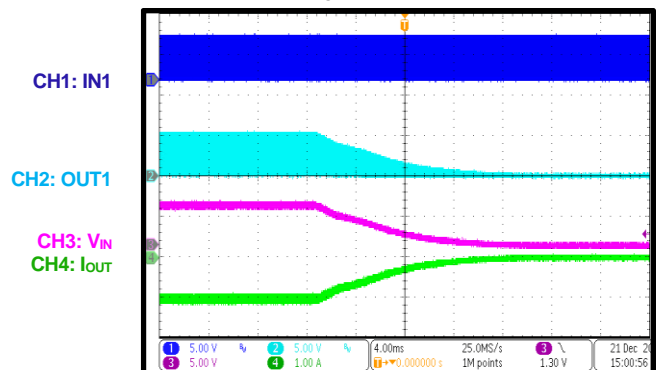

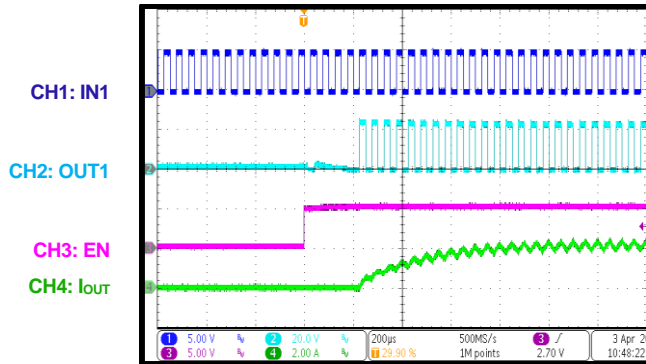
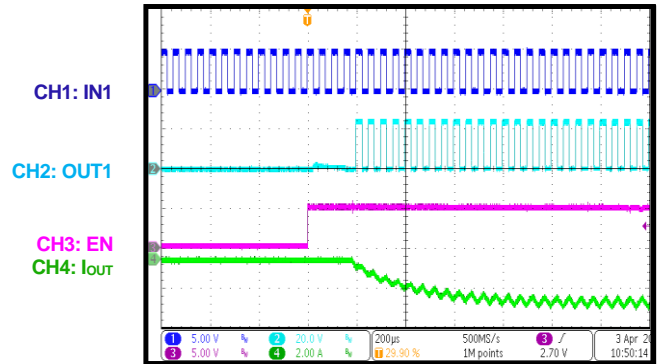
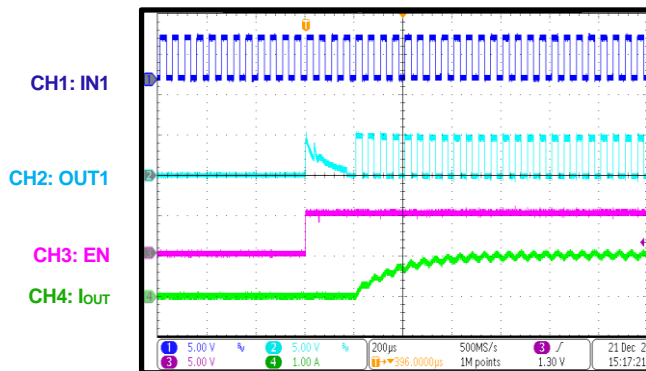
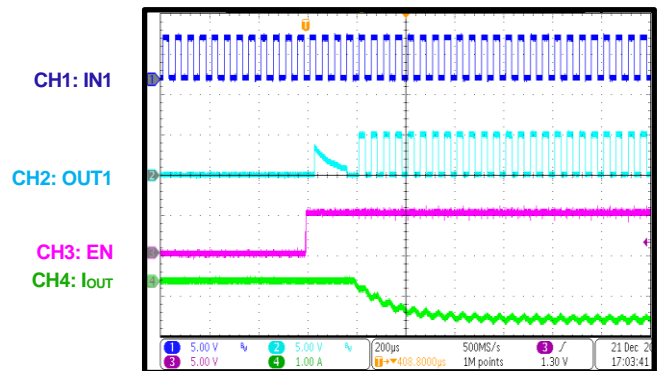
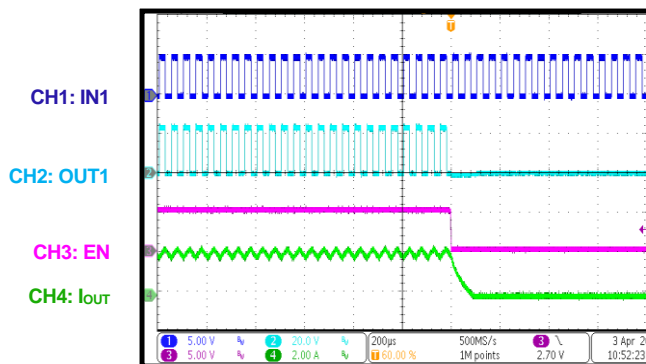
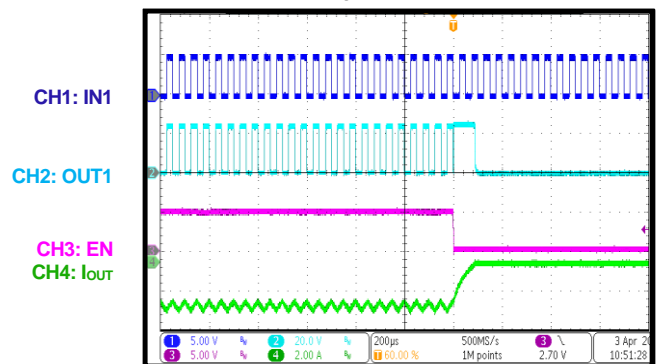

**TYPICAL PERFORMANCE CHARACTERISTICS (continued)**
 $V_{CC} = 3.3V$ ,  $EN = 5V$ ,  $IN1 = 20kHz$ , duty = 50%,  $T_A = 25^\circ C$ , unless otherwise noted.

**IC Enabled**
 $V_{IN} = 24V$ ,  $IN2 = \text{low}$ , load =  $5\Omega + 700\mu H$ 

**IC Enabled**
 $V_{IN} = 24V$ ,  $IN2 = \text{high}$ , load =  $5\Omega + 700\mu H$ 

**IC Enabled**
 $V_{IN} = 5V$ ,  $IN2 = \text{low}$ , load =  $2\Omega + 470\mu H$ 

**IC Enabled**
 $V_{IN} = 5V$ ,  $IN2 = \text{high}$ , load =  $2\Omega + 470\mu H$ 

**IC Disabled**
 $V_{IN} = 24V$ ,  $IN2 = \text{low}$ , load =  $5\Omega + 700\mu H$ 

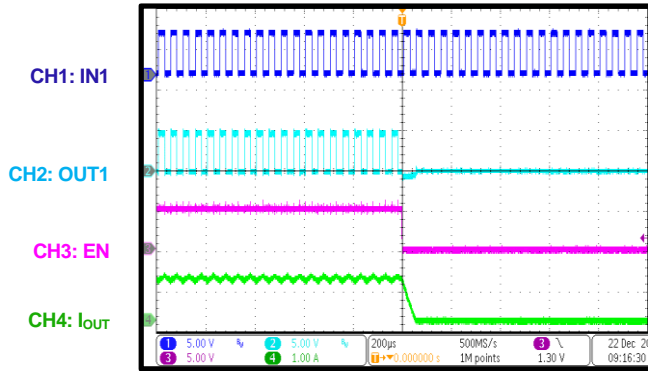
**IC Disabled**
 $V_{IN} = 24V$ ,  $IN2 = \text{high}$ , load =  $5\Omega + 700\mu H$ 

**TYPICAL PERFORMANCE CHARACTERISTICS (continued)**

$V_{CC} = 3.3V$ ,  $EN = 5V$ ,  $IN1 = 20kHz$ , duty = 50%,  $T_A = 25^{\circ}C$ , unless otherwise noted.

**IC Disabled**

$V_{IN} = 5V$ ,  $IN2 = low$ , load =  $2\Omega + 470\mu H$



**IC Disabled**

$V_{IN} = 5V$ ,  $IN2 = high$ , load =  $2\Omega + 470\mu H$

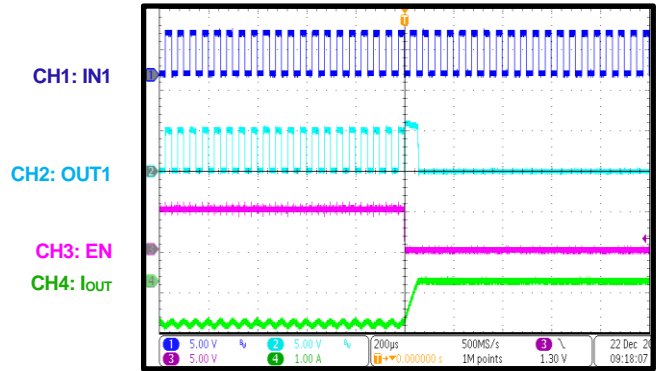

### FUNCTIONAL BLOCK DIAGRAM

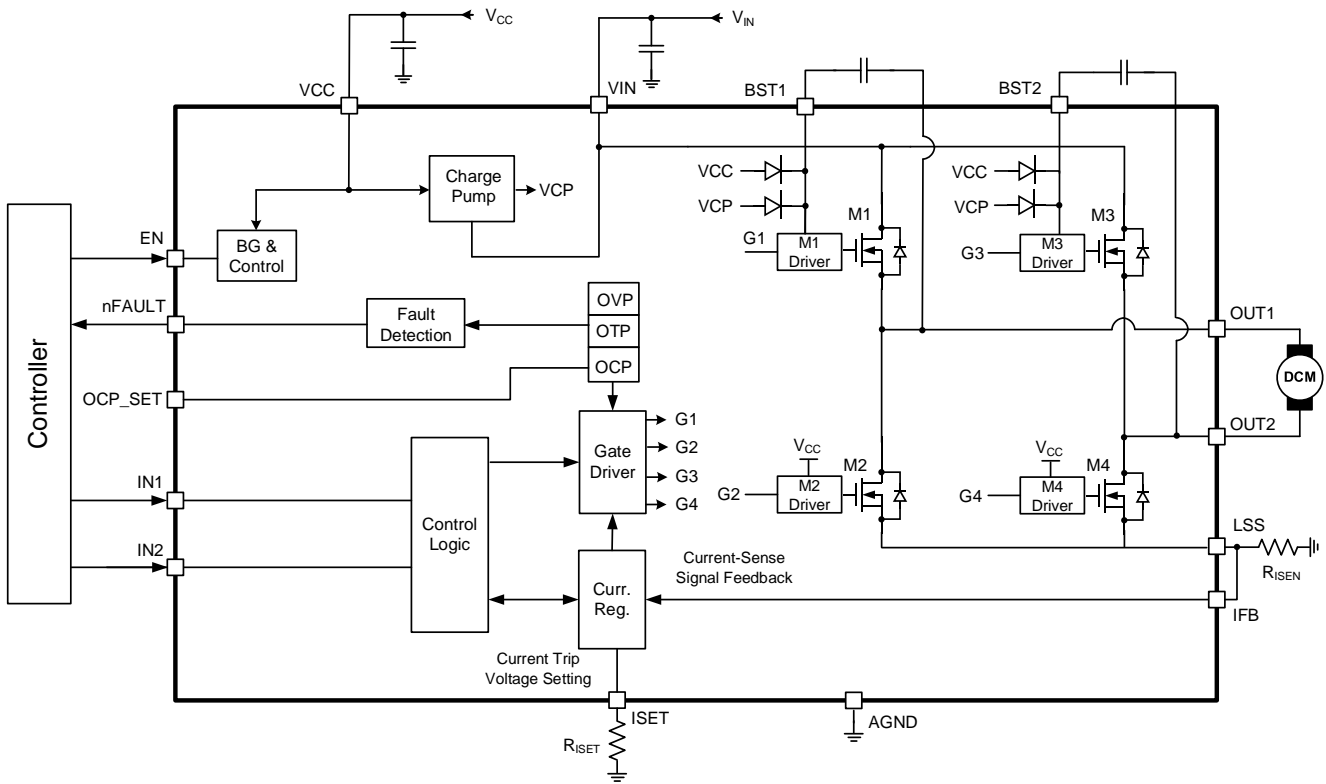

Figure 1: Functional Block Diagram

## OPERATION

The MP6619L is an H-bridge motor driver that operates from a supply input voltage ( $V_{IN}$ ) up to 28V and delivers a motor current up to 5A. Typically, the MP6619L drives a brushed DC motor.

### Input Logic

Each of the MP6619L's half-bridges is controlled independently via the EN, IN1, and/or IN2 pins (see Table 1).

**Table 1: Truth Table**

EN	INx	OUTx
0	x	Z
1	0	L
1	1	H

### Shutdown Mode

If the EN signal is pulled low, then the MP6619L shuts down. During shutdown, all circuits and blocks are disabled, and the MP6619L consumes below 1 $\mu$ A of shutdown current. There is a deglitch time of about 150ns on EN to avoid mistriggering.

### Current Limit

The MP6619L has a configurable current limit. The output current ( $I_{OUT}$ ) flowing through the two low-side MOSFETs (LS-FETs) is sensed by an external sense resistor. When  $I_{OUT}$  reaches the current trip threshold, a current limit condition is triggered. The entire H-bridge switches to a high-impedance state with all the MOSFETs turned off. After a fixed off time ( $t_{ITRIP}$ ), the MOSFETs are re-enabled, and the cycle repeats.

The current limit is triggered when the IFB pin voltage ( $V_{IFB}$ ) reaches the current trip voltage ( $V_{ITRIP}$ ). For example, if a 40m $\Omega$  sense resistor is connected from the LSS pin to ground and the current trip voltage ( $V_{ITRIP}$ ) is 200mV, then  $V_{IFB}$  reaches 200mV and a current trip occurs once  $I_{OUT}$  reaches 5A.

### Current Trip Voltage Setting

The current control trip value is set by connecting a resistor between the ISET pin and ground. When ISET is floating, the current trip voltage is set to the default 200mV. If a resistor is connected between ISET and ground, then the current trip voltage can drop below 200mV

to reduce power loss on the sense resistor. The MP6619L requires about 0.3ms to detect whether a resistor is available on ISET when the IC starts up for the first time ( $V_{CC} >$  under-voltage lockout, UVLO, and EN = 1). During this time, the IC is not switching. The relationship between the current trip voltage and ISET resistance ( $R_{ISET}$ ) can be calculated using Equation (1):

$$V_{ITRIP} (V) = 0.2 \times \frac{40}{R_{ISET} (k\Omega)} \quad (1)$$

For example, if  $R_{ISET}$  is 80k $\Omega$ , the trip voltage is 100mV. For improved accuracy, a 40k $\Omega$  to 80k $\Omega$  resistance is recommended to achieve a 200mV to 100mV current trip voltage.

### V<sub>CC</sub> Under-Voltage Lockout (UVLO)

Whenever the VCC voltage ( $V_{CC}$ ) falls below the UVLO threshold, all circuitry in the device is disabled and the internal logic resets. Once  $V_{CC}$  exceeds the UVLO threshold, the MP6619L resumes normal operation.

### High-Side MOSFET (HS-FET) Driver

The two high-side MOSFETs (HS-FETs) (M1 and M3) are N-channel MOSFETs. When the HS-FETs turn on, a bootstrap (BST) supply voltage ( $V_{BSTx}$ ) across BST1 and BST2 is required.  $V_{BSTx}$  is generated by a combination of the internal charge pump and  $V_{CC}$ . This allows the IC to operate at 100% duty cycle to provide sufficient driver voltage for the HS-FETs.

### Over-Current Protection (OCP)

The MP6619L provides over-current protection (OCP) for each MOSFET by floating the OCP\_SET pin. Pull OCP\_SET logic low to disable OCP.

The OCP circuit limits the current through each MOSFET by reducing the gate driver voltage to the MOSFET. If the MOSFET current remains in the OCP condition (exceeds the OCP threshold,  $I_{OCP}$ ) for longer than the OCP deglitch time, all MOSFETs in the H-bridge are disabled and nFAULT is pulled low. The driver remains disabled during the OCP retry time ( $t_{OCP}$ ) and then is re-enabled automatically.

Table 2 shows the OCP setting options.

**Table 2: OCP Setting**

OCP_SET	Over-Current Protection
Float	Enabled
0	Disabled

### Input Over-Voltage Protection (OVP)

During the freewheeling time, the energy stored in  $I_{OUT}$  is delivered to the input side. When  $V_{IN}$  and  $I_{OUT}$  are sufficiently high, the energy sent back to the input side causes  $V_{IN}$  to increase. The MP6619L employs  $V_{IN}$  protection to avoid IC damage due to a high voltage spike.

If  $V_{IN}$  exceeds the OVP threshold, the H-bridge output is disabled and nFAULT is pulled low. This protection is released once  $V_{IN}$  drops to a safe level.

### Junction Over-Temperature Protection (OTP)

If the die temperature exceeds safe limits, all H-bridge MOSFETs are disabled and nFAULT is pulled low. Once the die temperature drops to a safe level, the MP6619L resumes normal operation automatically.

### Fault Indication Output (nFAULT)

The MP6619L provides an nFAULT pin that is pulled active low if any of the protection circuits are activated. These fault conditions include OCP, over-temperature protection (OTP), and over-voltage protection (OVP). If a current-limit trip occurs, then nFAULT is also pulled low. nFAULT is an open-drain output and requires an external pull-up resistor. Once the fault condition is removed, nFAULT is pulled inactive high via the pull-up resistor.

### Enable and Disable (EN)

To enable the MP6619L, apply a logic high signal to EN, where the high-level signal time must exceed about 10 $\mu$ s. To shut down the IC, pull EN logic low and set the low-level signal above 100ns.

## APPLICATION INFORMATION

### Selecting the Input Capacitor

The input capacitor ( $C_{IN}$ ) reduces the surge current drawn from the input supply as well as the switching noise from the device.  $C_{IN}$  impedance at the switching frequency ( $f_{SW}$ ) must be below the input source impedance to prevent the high-frequency switching current from passing through to the input. Ceramic capacitors with X5R or X7R dielectrics are recommended for their low ESR and small temperature coefficients. A high-value capacitor is helpful for reducing  $V_{IN}$  ripple and noise. For most applications, two 22 $\mu$ F ceramic capacitors in parallel are sufficient. It is recommended to connect one capacitor to each VIN pin.

### Setting the Output Current limit

If a resistor is connected between ISET and ground, then the output current limit ( $I_{OUT\_LIM}$ ) can be calculated using Equation (2):

$$I_{OUT\_LIM} (A) = 0.2 \times \frac{40}{R_{ISET} (k\Omega)} \times \frac{1}{R_{ISEN} (\Omega)} \quad (2)$$

If ISET remains floating, then  $I_{OUT\_LIM}$  can be calculated using Equation (3):

$$I_{OUT\_LIM} (A) = \frac{0.2}{R_{ISEN} (\Omega)} \quad (3)$$

For example, if  $R_{ISET}$  is 80k $\Omega$ , then the trip voltage is 100mV. For improved accuracy, a 40k $\Omega$  to 80k $\Omega$  resistance is recommended to achieve a 200mV to 100mV current trip voltage.

### Setting the Sense Resistor

The sensing resistor's power loss ( $P_{LOSS\_RIFB}$ ) can be calculated using Equation (4):

$$P_{LOSS\_RIFB} (W) = \frac{V_{ITRIP}^2 (V)}{R_{ISEN} (\Omega)} \quad (4)$$

To guarantee a current reference, the sensing resistor's nominal power rating is recommended to be two times the calculated power loss with at least a 1% accuracy resistor.

### PCB Layout Guidelines

Efficient PCB layout is critical for stable operation. For the best results, refer to Figure 2 and follow the guidelines below:

1. Place the input bypass capacitor as close as possible to the VIN, VCC, and GND pins.
2. Use a wide copper plane for the input, output, and ground connection to improve thermal performance.
3. Place as many GND vias near the output capacitor ( $C_{OUT}$ ) and  $C_{IN}$  as possible to improve thermal performance.
4. Keep the sense resistor loop as short as possible.
5. Keep the current-sense feedback signal far away from noise sources.

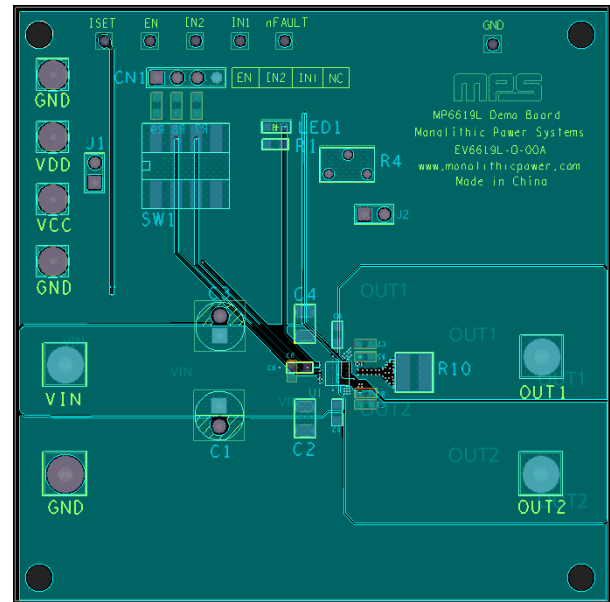

**Figure 2: Recommended PCB Layout**

TYPICAL APPLICATION CIRCUIT

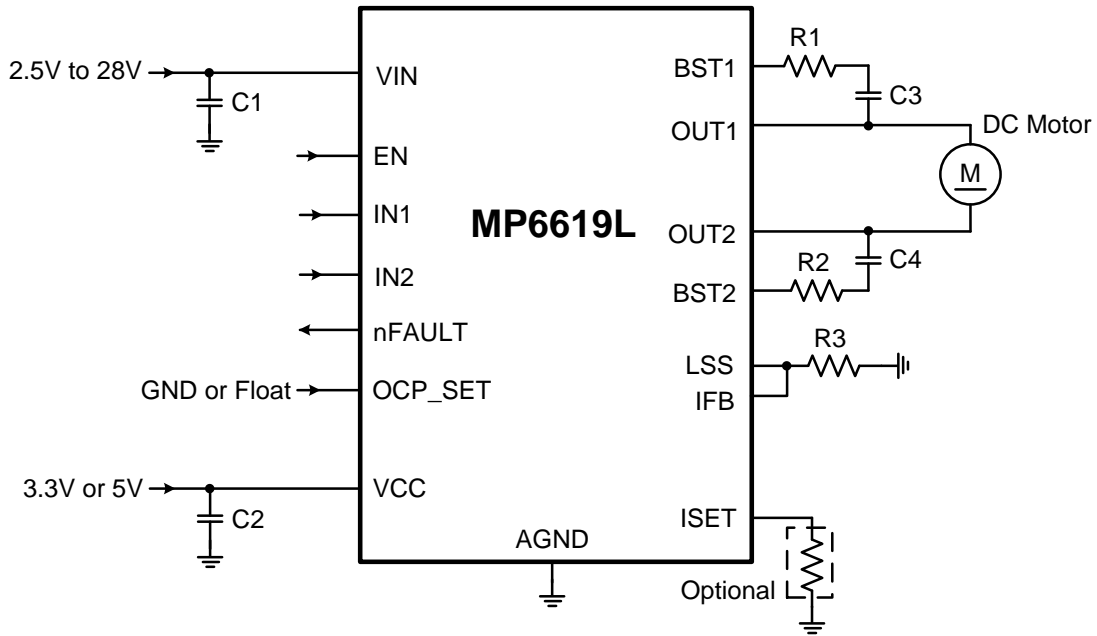
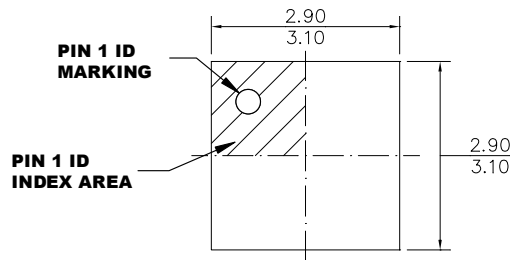

Figure 3: Typical Application Circuit



# PACKAGE INFORMATION

## QFN-19 (3mmx3mm)



**TOP VIEW**

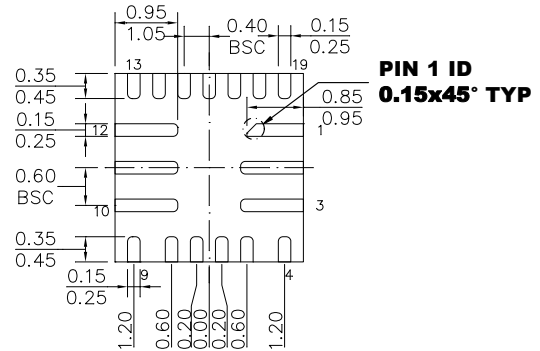

**BOTTOM VIEW**

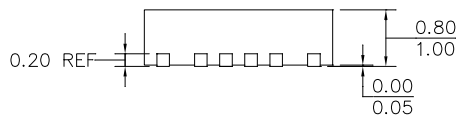

**SIDE VIEW**

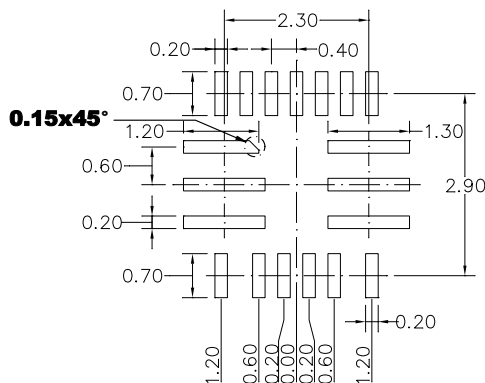

**RECOMMENDED LAND PATTERN**

**NOTE:**

- 1) LAND PATTERNS OF PINS 2, 3, 10, 11, AND 12 HAVE THE SAME SHAPE.
- 2) ALL DIMENSIONS ARE IN MILLIMETERS.
- 3) LEAD COPLANARITY SHALL BE 0.10 MILLIMETERS MAX.
- 4) JEDEC REFERENCE IS MO-220.
- 5) DRAWING IS NOT TO SCALE.

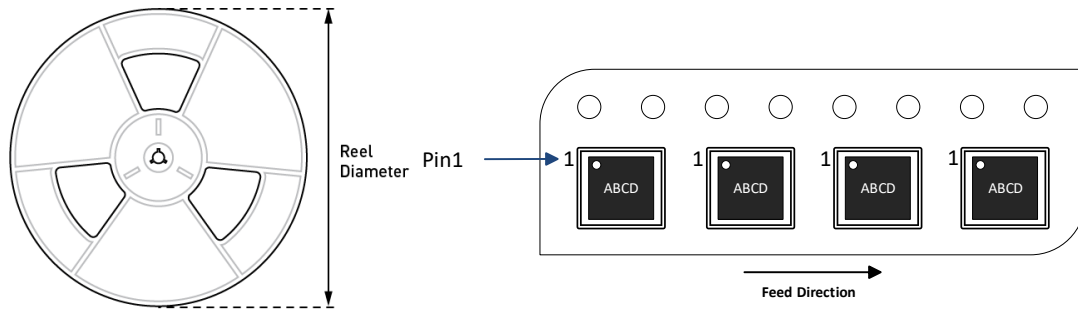
**CARRIER INFORMATION**

Part Number	Package Description	Quantity/ Reel	Quantity/ Tube	Quantity/ Tray	Reel Diameter	Carrier Tape Width	Carrier Tape Pitch
MP6619LGQ-Z	QFN-19 (3mmx3mm)	5000	N/A	N/A	13in	12mm	8mm