

DESCRIPTION

The MP6906 is a low-drop diode emulator IC that combines an external switch to replace Schottky diodes in high-efficiency flyback converters. The chip regulates the forward drop of an external switch to about 30mV and switches it off as soon as the voltage becomes negative.

The MP6906 provides a SYNC interface to receive an external signal to shut down the gate driver for reliable continuous conduction mode (CCM) operation. A programmable light-load sleep mode reduces the IC's quiescent current to 150µA. Also, it has a low UVLO level for operation at a lower output without an additional winding. Rail-to-rail output provides higher driving voltage to the external MOSFET.

The MP6906 is available in compact SOIC-8 and TSOT23-6 packages.

FEATURES

- Works with 12V Standard and 5V Logic Level FETS
- Fast Turn-Off Total Delay of 25ns
- 4.2V~35V Wide V_{DD} Operating Range
- 30mV V_{DS} Regulation Function ⁽¹⁾
- 150µA Quiescent Current in Light-Load Mode ⁽¹⁾
- Supports DCM and Quasi-Resonant Operation
- SYNC Interface for CCM Operation
- Supports High-side and Low-side Rectification
- Power Savings of up to 1.5W in a Typical Notebook Adapter
- SOIC-8 and TSOT23-6 Packages

APPLICATIONS

- Industrial Power Systems
- Distributed Power Systems
- Battery Powered Systems
- Flyback Converters

All MPS parts are lead-free, halogen-free, and adhere to the RoHS directive. For MPS green status, please visit the MPS website under Quality Assurance.

"MPS" and "The Future of Analog IC Technology" are registered trademarks of Monolithic Power Systems, Inc.

NOTE:

1) Related issued patent: US Patent US8,067,973; US8,400,790. CN Patent ZL201010504140.4; ZL200910059751.X. Other patents pending.

TYPICAL APPLICATION

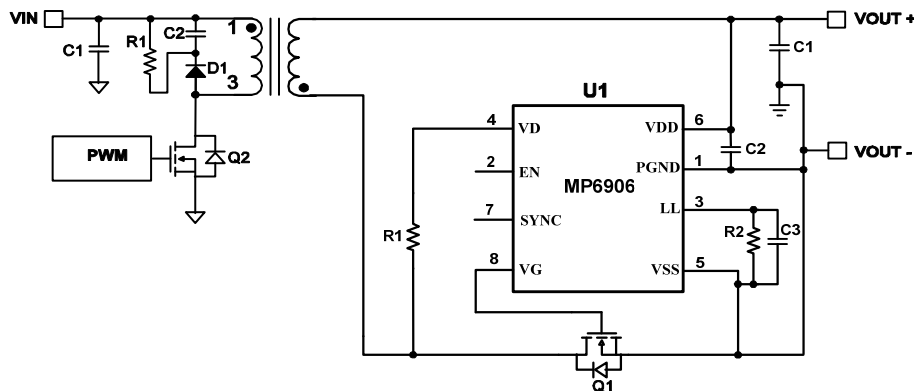

ORDERING INFORMATION

Part Number	Package	Top Marketing
MP6906GS	SOIC-8	<i>See Below</i>
MP6906GJ	TSOT23-6	<i>See Below</i>

* For Tape & Reel, add suffix -Z (e.g. MP6906GS-Z)

* For Tape & Reel, add suffix -Z (e.g. MP6906GJ-Z)

TOP MARKING (MP6906GS)

MP6906
LLLLLLL
MPSYWW

MP6906: Product code of MP6906GS

MPS: MPS prefix

Y: Year code

WW: Week code

LLL: Lot number

TOP MARKING (MP6906GJ)

|AMQY

MMQ: Product code of MP6906GJ

Y: Year code

PACKAGE REFERENCE

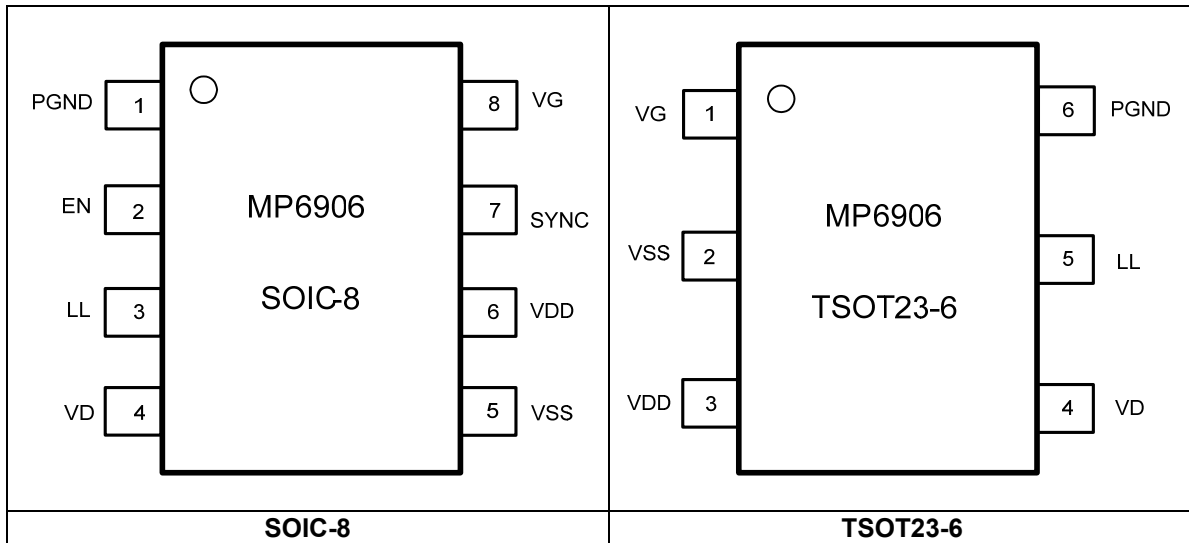

Absolute Maximum Ratings ⁽²⁾

V_{DD} to V_{SS}	-0.3V to +38V
PGND to V_{SS}	-0.3V to +0.3V
V_G to V_{SS}	-0.3V to +20V
V_D to V_{SS}	-1V to +180V
SYNC, LL, EN to V_{SS}	-0.3V to +6.5V
Continuous power dissipation ($T_A = +25^\circ\text{C}$) ⁽³⁾	
SOIC-8	1.4W
TSOT23-6	0.57W
Junction temperature	150°C
Lead temperature (solder)	260°C
Storage temperature	-55°C to +150°C

Recommended Operation Conditions ⁽⁴⁾

V_{DD} to V_{SS}	4.2V to 35V
Operating junction temp. (T_J) ..	-40°C to +125°C

Thermal Resistance ⁽⁵⁾ θ_{JA} θ_{JC}

SOIC-8	90	45	°C/W
TSOT23-6	220	110	°C/W

NOTES:

- 2) Exceeding these ratings may damage the device.
- 3) The maximum allowable power dissipation is a function of the maximum junction temperature $T_J(\text{MAX})$, the junction-to-ambient thermal resistance θ_{JA} , and the ambient temperature T_A . The maximum allowable continuous power dissipation at any ambient temperature is calculated by $P_D(\text{MAX}) = (T_J(\text{MAX}) - T_A) / \theta_{JA}$. Exceeding the maximum allowable power dissipation will produce an excessive die temperature, causing the regulator to go into thermal shutdown. Internal thermal shutdown circuitry protects the device from permanent damage.
- 4) The device is not guaranteed to function outside of its operating conditions.
- 5) Measured on JESD51-7, 4-layer PCB.

ELECTRICAL CHARACTERISTICS

$V_{DD} = 12V$, $-40^{\circ}C \leq T_J \leq +125^{\circ}C$, unless otherwise noted.

Parameter	Symbol	Conditions	Min	Typ	Max	Units
V_{DD} voltage range			4.2		35	V
V_{DD} UVLO rising					4.2	V
V_{DD} UVLO hysteresis			0.13			V
Operating current	I_{CC}	$C_{LOAD} = 5nF$, $F_{SW} = 100kHz$		8	10	mA
Quiescent current	I_q	$V_{SS} - V_D = 0.5V$		2	3	mA
Shutdown current ⁽⁶⁾		$V_{DD} = 4V$, $EN=0V$			150	μA
		$V_{DD} = 20V$, $EN = 0V$			200	
Light-load mode current				150	220	μA
Thermal shutdown ⁽⁷⁾				150		$^{\circ}C$
Thermal shutdown hysteresis ⁽⁷⁾				30		$^{\circ}C$
Enable UVLO rising	V_{EN-R}		1.2	1.5	1.8	V
Enable UVLO hysteresis			0.1	0.2		V
Internal pull-up current on EN				10	18	μA
Control Circuitry Section						
$V_{SS}-V_D$ forward voltage	V_{fwd}		12	23	34	mV
Turn-off threshold ($V_{SS}-V_D$)			-6	3	12	mV
Turn-on delay	T_{Don}	$C_{LOAD} = 5nF$, $V_{GS} = 2V$		200	300	ns
		$C_{LOAD} = 10nF$, $V_{GS} = 2V$		250	450	ns
Input bias current on VD		$V_D = 180V$			1	μA
Turn-on blanking time	T_{B_ON}	$C_{LOAD} = 5nF$	1.2	1.9	2.7	μs
Turn-off blanking V_{DS} threshold	V_{B_OFF}		1.4		2	V
Turn-off threshold on SYNC	V_{SYN}		1.6	2	2.4	V
Internal pull-down current on SYNC		$V_{SYN} = 5V$		10	15	μA
Light-load-enter SYNC duration	T_{SYN}		75	95	115	μs
Light-load-enter pulse width	T_{LL}	$R_{LL} = 200k\Omega$	2.2	3.6	4.9	μs
Light-load-enter pulse width hysteresis	T_{LL-H}	$R_{LL} = 200k\Omega$		0.6		μs
Gate disable threshold on LL	V_{LL_DIS}			0.2	0.31	V
Turn-on threshold (V_{DS})	V_{LL-DS}	$V_{DD} = 12V$	-400	-275	-150	mV
Gate Driver Section						
V_G (low)	V_{G-L}	$I_{LOAD} = 1mA$		0.05	0.1	V
V_G (high)	V_{G-H}	$V_{DD} > 10.5V$	10.5	12	13	V
		$V_{DD} \leq 10.5V$		V_{DD}		
SYNC turn-off propagation delay				40	70	ns
Turn-off propagation delay		$V_D = V_{SS}$		25	50	ns
Turn-off total delay	T_{Doff}	$V_D = V_{SS}$, $C_{LOAD} = 5nF$, $R_{GATE} = 0\Omega$, $V_{GS} = 2V$		35	60	ns
		$V_D = V_{SS}$, $C_{LOAD} = 10nF$, $R_{GATE} = 0\Omega$, $V_{GS} = 2V$		45	95	ns
Pull-down impedance				1	2	Ω

NOTE:

- 6) Only for SOIC package
- 7) Guaranteed by characterization.

PIN FUNCTIONS

Pin # (SOIC-8)	Pin # (TSOT23-6)	Name	Description
1	6	PGND	Power ground. PGND is the return for the driver switch.
2	-	EN	Enable. Active high.
3	5	LL	Light-load timing setting. Connect a resistor to set the light-load timing. Leave LL open, or the IC will never enter light-load mode. Pulling LL low disables the gate driver.
4	4	VD	FET drain voltage sense.
5	2	VSS	Ground. VSS is also used as reference for VD.
6	3	VDD	Supply voltage.
7	-	SYNC	Interface for external signal control. Pulling SYNC high shuts down the gate driver immediately.
8	1	VG	Gate drive output.

TYPICAL PERFORMANCE CHARACTERISTICS

$V_{DD} = 12V$, unless otherwise noted.

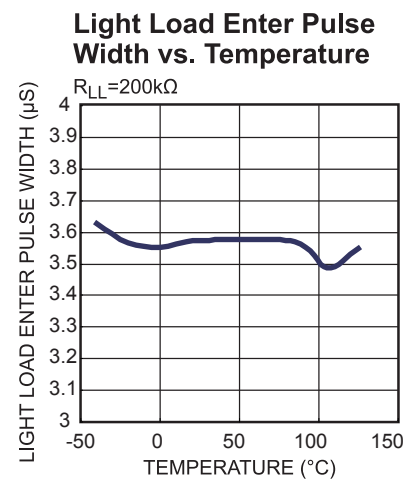
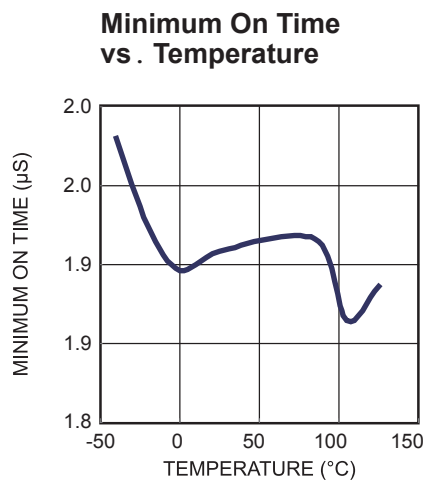
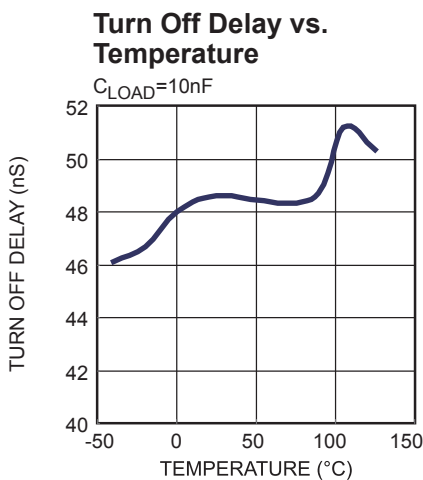
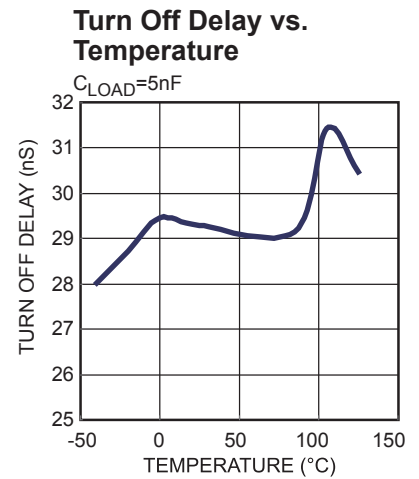
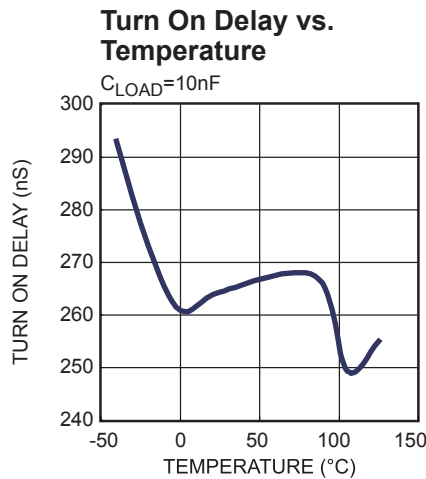
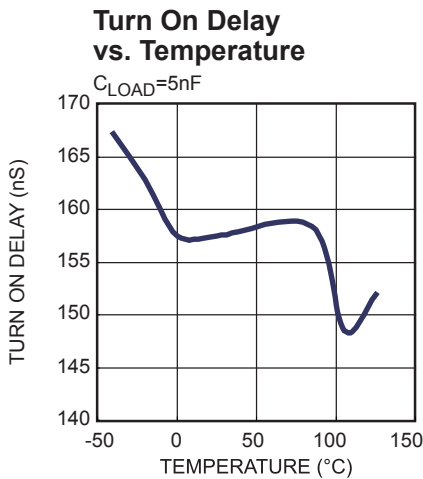
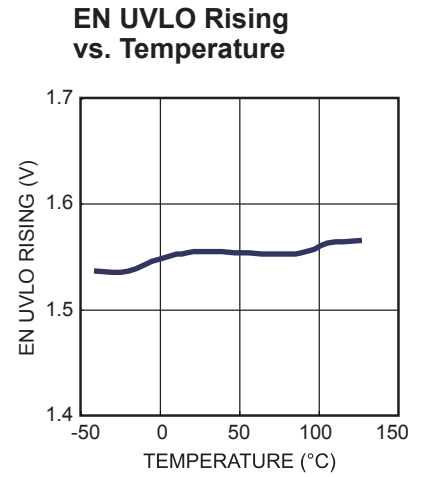
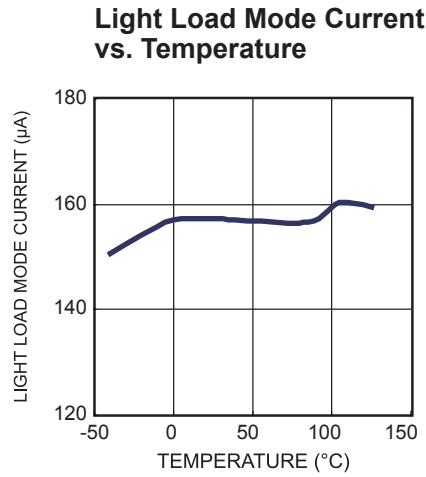
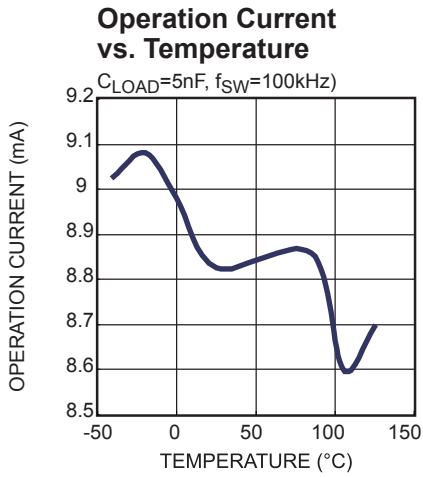

TYPICAL PERFORMANCE CHARACTERISTICS *(continued)*

$V_{DD} = 12V$, unless otherwise noted.

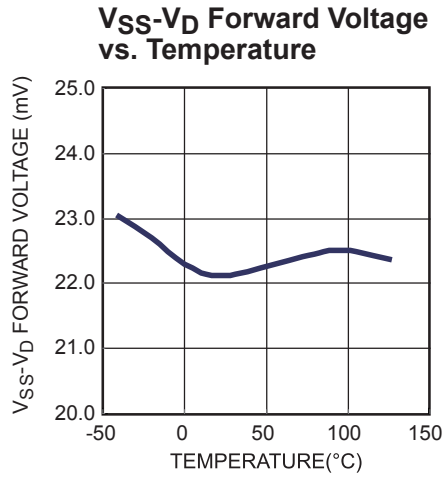

TYPICAL PERFORMANCE CHARACTERISTICS (continued)

$V_{DD} = 12V$, unless otherwise noted.

Operation in 90W Flyback Application

$V_{IN}=90Vac$ $I_{OUT}=1A$

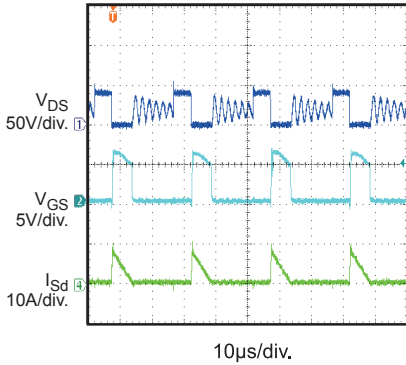
Operation in 90W Adapter Application

$V_{IN}=90Vac$ $I_{OUT}=4.7A$

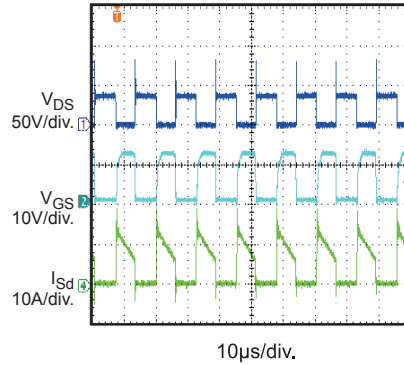
Operation in 90W Flyback Application

$V_{IN}=250Vac$ $I_{OUT}=1A$

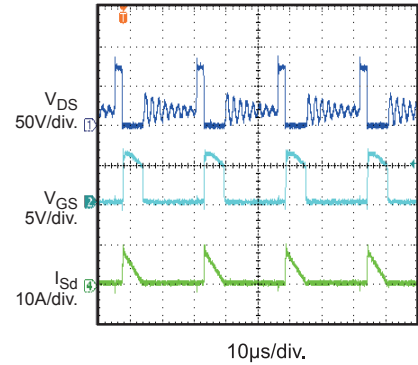
Operation in 90W Adapter Application

$V_{IN}=250Vac$ $I_{OUT}=4.7A$

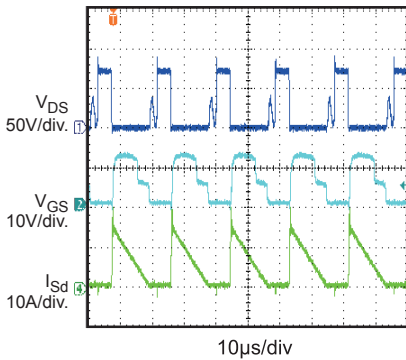
NOTE:

8) See Figure 20 for test circuit.

FUNCTIONAL BLOCK DIAGRAM

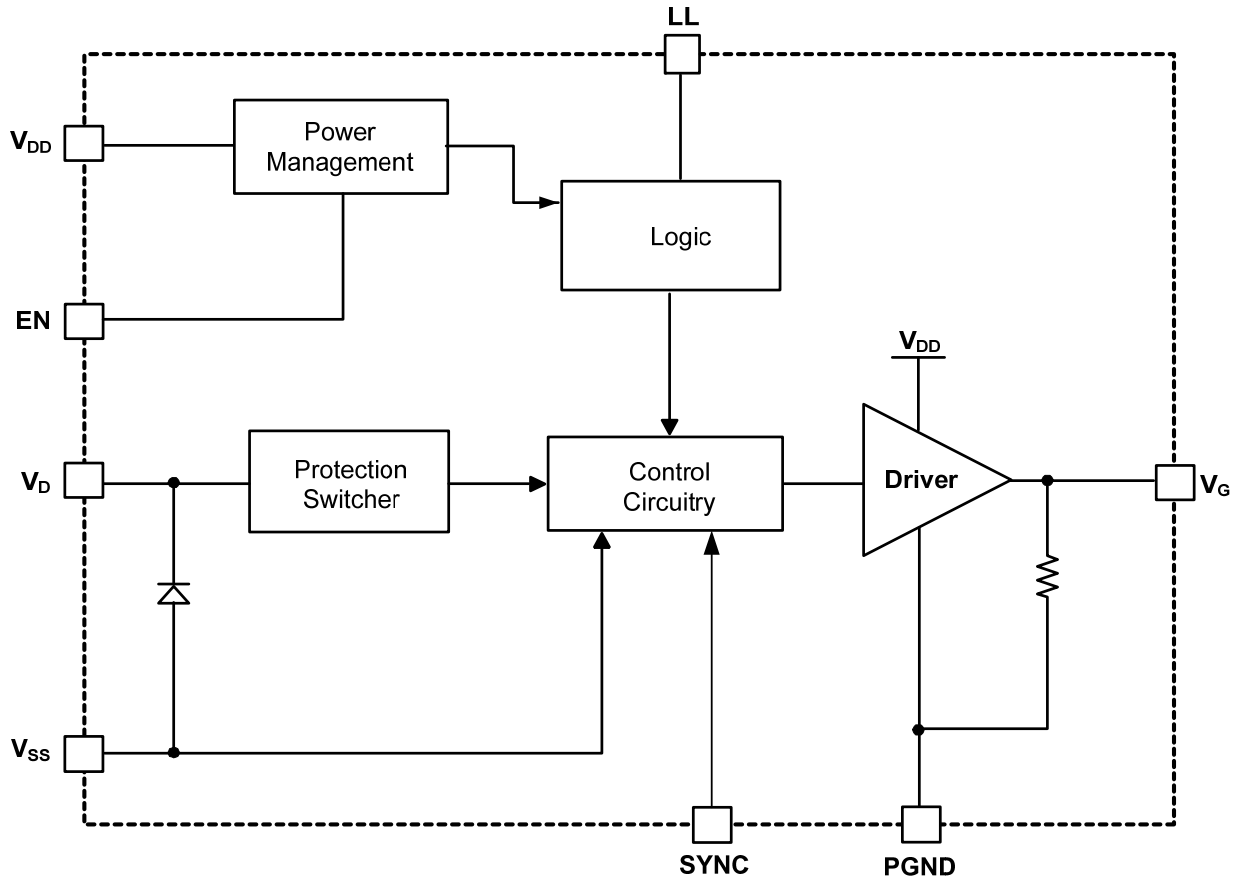

Figure 1: MP6906 Block Diagram

OPERATION

The MP6906 supports operation in DCM and quasi-resonant flyback converters. The control circuitry controls the gate in forward mode and turns the gate off when the MOSFET current is fairly low.

VD Clamp

Because V_D can go as high as 180V, a high-voltage JFET is used at the input. To avoid excessive currents when V_g drops below $-0.7V$, a $1k\Omega$ resistor is recommended between V_D and the drain of the external MOSFET.

Under-Voltage Lockout (UVLO)

When V_{DD} is below the 4.2V UVLO threshold, the part enters sleep mode, and V_G remains at a low level.

Enable (EN)

If EN is pulled low, the part is in shutdown mode, which consumes $<150\mu A$ shutdown current.

If EN is pulled high during the rectification cycle, the gate driver will not start until the next rectification cycle starts (see Figure 2).

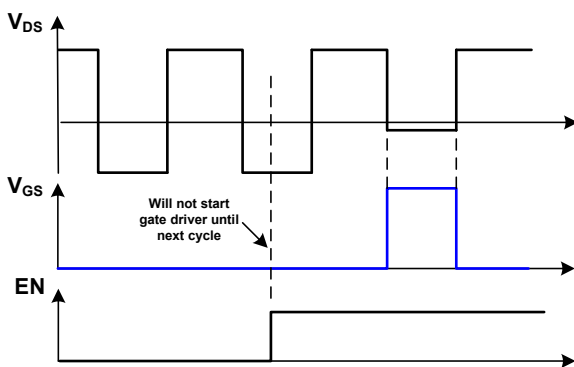

Figure 2: EN Control Scheme

Thermal Shutdown

If the junction temperature of the chip exceeds $150^\circ C$, V_g is pulled low, and the part stops switching. The part returns to normal operation after the junction temperature has dropped to $120^\circ C$.

Turn-On Phase

When the switch current flows through the body diode of the MOSFET, there is a negative V_{DS} ($V_D - V_{SS}$) across it ($<-500mV$). The V_{DS} is much lower than the forward voltage drop of the control circuitry ($-30mV$), which turns on the MOSFET

after a turn-on delay (see Figure 3). **Turn-On Blanking**

The control circuitry contains a blanking function. When the MOSFET turns on, the control circuitry ensures the on state lasts for a specific period of time. The turn-on blanking time is $\sim 1.6\mu s$, during which the turn-off threshold is blanked (see Figure 3).

Conduction Phase

When V_{ds} rises above the forward voltage drop ($-30mV$), according to the decrease of the switching current, the MP6906 pulls down the gate voltage level to make the on resistance of the synchronous MOSFET larger to ease the rise of V_{ds} .

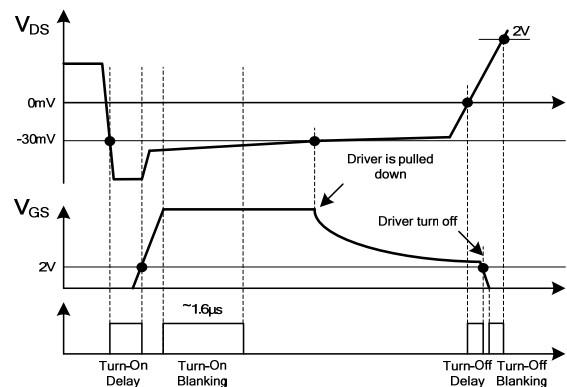

Figure 3: Turn On/Off Timing Diagram

With this control scheme, V_{DS} is adjusted to around $-30mV$, even when the current through the MOSFET is fairly low. This function keeps the driver voltage at a very low level when the synchronous MOSFET is about to be turned off, which boosts the turn-off speed.

Turn-Off Phase

When V_{DS} rises to trigger the turn-off threshold ($0mV$), the gate voltage is pulled to zero after a very short turn-off delay (see Figure 3).

Turn-Off Blanking

After the gate driver is pulled to zero by V_{DS} reaching the turn-off threshold ($0mV$), a turn-off blanking time is applied, during which the gate driver signal is latched off. The turn-off blanking is removed when the V_{DS} voltage rises above $2V$ (see Figure 3).

SYNC Turn-Off for CCM Operation

An external turn-off signal can be applied on SYNC to turn-off the gate driver signal, which provides more reliable operation in CCM.

A rising edge, exceeding 2V, applied on SYNC turns off the gate driver signal immediately (see Figure 4).

The gate driver of the MP6906 will remain low as long as the SYNC voltage is high.

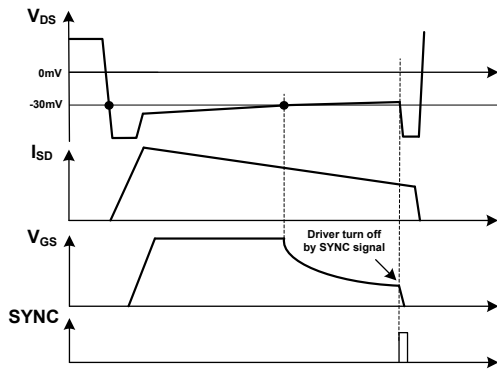

Figure 4: SYNC Turn Off for CCM

Light-Load Latch-Off Function

The gate driver of the MP6906 is latched off to save driver loss and improve efficiency during a light-load condition.

When the synchronous MOSFET conducting period remains lower than T_{LL} for longer than the light-load-enter delay ($T_{LL-Delay}$), the MP6906 enters light-load mode and latches off the gate driver (see Figure 5). The synchronous MOSFET conducting period lasts from the time the gate driver turns on until V_{GS} drops below 1V (V_{LL-GS}).

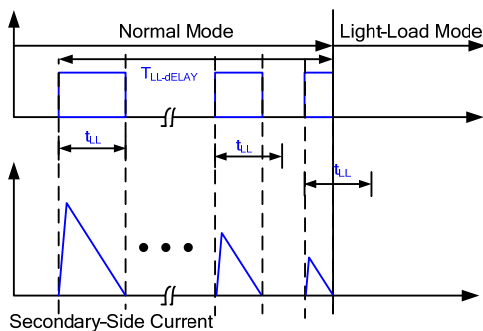

Figure 5: MP6906 Enters Light-Load Mode

The light-load-enter timing (T_{LL}) is programmable by connecting a resistor (R_{LL}) on LL. By

monitoring the LL current (the LL voltage remains at $\sim 2V$ internally), T_{LL} is set. A 1nF capacitor is recommended to decouple the noise on LL. See Equation (1)

$$T_{LL} = R_{LL} (k\Omega) \cdot \frac{3.6\mu s}{200k\Omega} \quad (1)$$

During light-load mode, the MP6906 monitors the synchronous MOSFET body diode conducting period by sensing the time duration of when V_{DS} is below $-250mV$ (V_{LL-DS}). If the time duration is longer than $T_{LL} + T_{LL-H}$ (T_{LL-H} is the light-load-enter pulse width hysteresis), the light-load mode ends, and the gate driver is unlatched to re-start the synchronous rectification (see Figure 6).

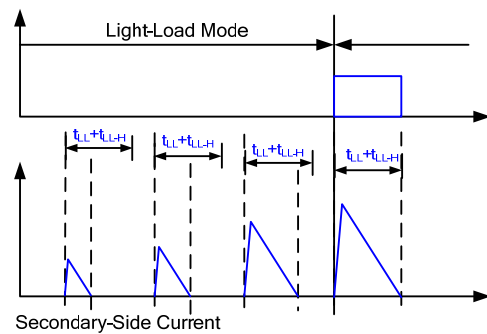

Figure 6: MP6906 Exits Light-Load Mode

The MP6906 enters light-load mode when the SYNC voltage is pulled high ($>2V$) for more than 100 μs . The light-load mode ends once the SYNC voltage is pulled low (see Figure 7).

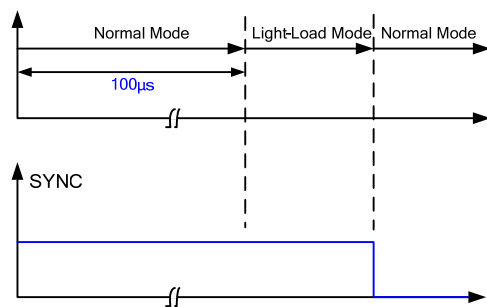

Figure 7: Light-Load Mode Controlled by SYNC

If the light-load mode ends during the rectification cycle, the gate driver signal will not show up until the next rectification cycle starts (see Figure 8).

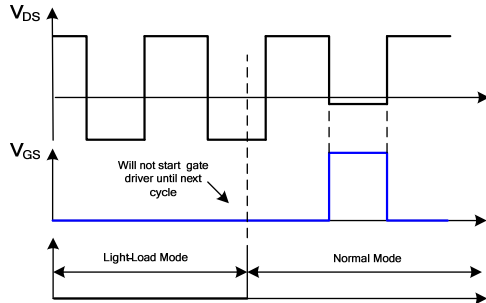

Figure 8: Gate Driver Start after Existing Light-Load Mode

Typical System Implementations

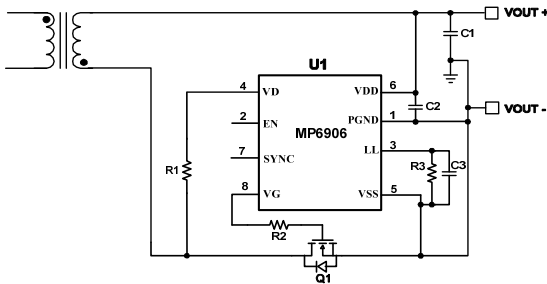

Figure 9: IC Power derived directly from Output Voltage

Figure 9 shows the typical system implementation for the IC power supply directly derived from the output voltage, which is available in low-side rectification. The IC benefits from the wide V_{DD} operating range (4.2V to 35V). The MP6906 supports most application fields with low-side rectification by directly deriving the supply power from the system output.

If the output voltage is out of the V_{DD} operating range or high-side rectification is used, an auxiliary winding solution for the IC's power supply is recommended (see Figure 10 and Figure 11). The auxiliary winding turn count (N_{au}) can be set using Equation (2):

$$N_{au} = \frac{V_{DD}}{V_{OUT}} \cdot N_s \quad (2)$$

Where N_s is the secondary winding turn count.

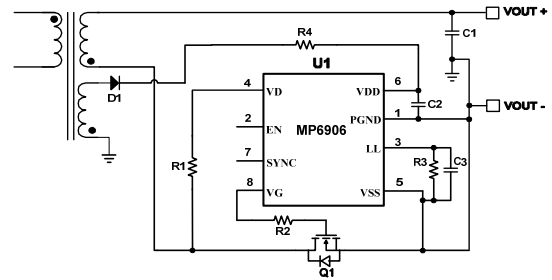

Figure 10: IC Power Derived from the Auxiliary Winding in Low-Side Rectification

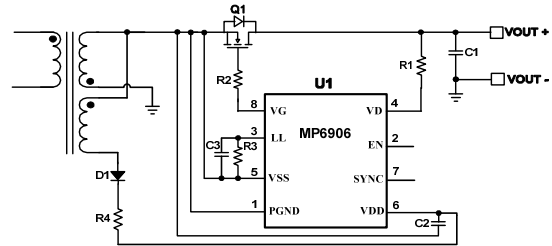

Figure 11: IC Power Derived from the Auxiliary Winding in High-Side Rectification

A simple non-auxiliary-winding solution for the IC's power supply is provided in Figure 12 and Figure 13. The IC power is derived from the secondary transformer winding through a diode. When using this power solution, make sure the winding voltage is lower than the higher limit of the V_{DD} operating range (35V). The winding voltage is $V_s = V_{OUT} + V_{IN_MAX}/n$ in Figure 12 where V_{OUT} is the output voltage; V_{IN_MAX} is the maximum input voltage, and n is the transformer turn ratio. $V_s = V_{IN_MAX}/n$ in Figure 13.

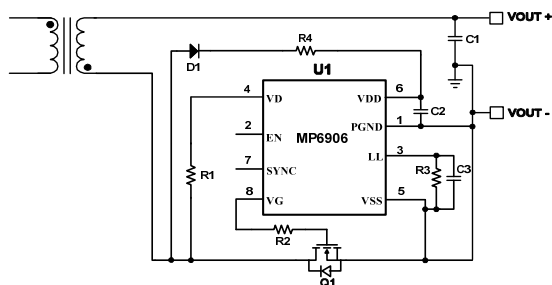

Figure 12: IC Power Derived from the Secondary Winding in Low-Side Rectification

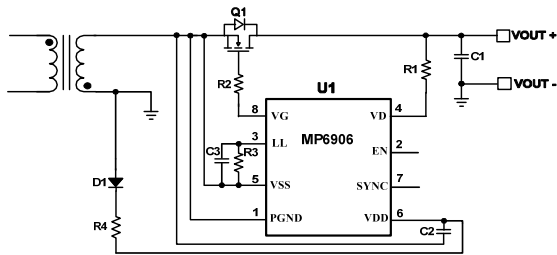

Figure 13: IC Power Derived from the Secondary Winding in High-Side Rectification

If the secondary winding voltage exceeds the higher limit of the V_{DD} operating range (35V), an external LDO circuit with a Zener diode is needed for the non-auxiliary-winding solution (see Figure 14 and Figure 15).

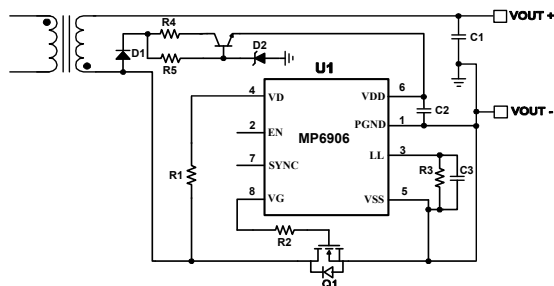

Figure 14: IC Power Derived from the Secondary Winding through an External LDO in Low-Side Rectification

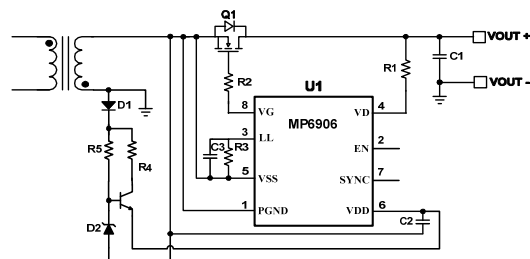

Figure 15: IC Power Derived from the Secondary Winding through an External LDO in High-Side Rectification

SR MOSFET Selection

Power MOSFET selection is a trade off between $R_{DS(ON)}$ and Q_g . To achieve higher efficiency, a MOSFET with a smaller $R_{DS(ON)}$ is preferred. Usually Q_g is larger with the $R_{DS(ON)}$ smaller, which makes the turn-on/off speed lower and leads to larger power loss, including driver loss. Because V_{DS} is adjusted at $\sim 30\text{mV}$ during the driving period (when the switching current is fairly small), a MOSFET with too low $R_{DS(ON)}$ is not recommended because the gate driver will be

pulled low when $V_{DS} = -I_{SD} \times R_{DS(ON)}$ becomes larger than -50mV . The $R_{DS(ON)}$ of the MOSFET's will not contribute to conduction loss. The conduction loss is $P_{CON} = -V_{DS} \times I_{SD} \approx I_{SD} \times 30\text{mV}$.

Figure 16 shows the typical waveform of a QR flyback. Assuming a 50% duty cycle, the output current is I_{OUT} .

To achieve fairly high use of the MOSFET's $R_{DS(ON)}$, the MOSFET should be turned on completely for at least 50% of the SR conduction period. See Equation (3):

$$V_{ds} = -I_c \times R_{on} = -2 \cdot I_{OUT} \times R_{on} \leq -V_{fwd} \quad (3)$$

Where V_{DS} is the drain-source voltage of the MOSFET, and V_{fwd} is the forward voltage threshold ($\sim 30\text{mV}$).

The MOSFET's $R_{DS(ON)}$ is recommended no lower than $\sim 15/I_{OUT}$ (m Ω). (For example, for a 5A application, the $R_{DS(ON)}$ of the MOSFET is recommended no lower than 3m Ω .)

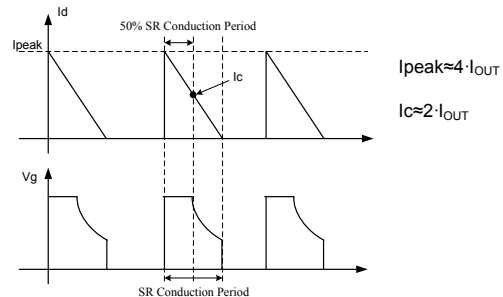

Figure 16: Synchronous Rectification Typical Waveforms in QR Flyback

PCB Layout Guidelines

Efficient PCB layout is critical for optimal operation. For best results, refer to Figure 17, Figure 18, and Figure 19 and follow the guidelines below:

Sensing for V_D/V_{SS}

- 1.) Make the sensing connection (V_D/V_{SS}) as close as possible to the MOSFET (drain/source).
- 2.) Make the sensing loop as small as possible and place the V_D resistor close to V_D .
- 3.) Keep the IC out of the power loop to make sure the sensing loop and power loop do not interrupt each other (see Figure 17).

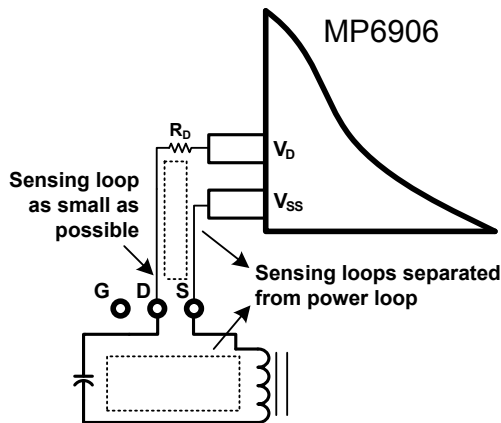

Figure 17: Voltage Sensing for V_D/V_{SS} on MP690

- Place a decoupling ceramic capacitor (no smaller than $1\mu F$) from VDD to PGND close to the IC to get adequate filtering.

Gate Driver Loop

- Make the gate driver loop as small as possible in order to minimize the parasitic inductance.
- Keep the driver signal far away from the VD sensing trace on the layout.

Layout Example

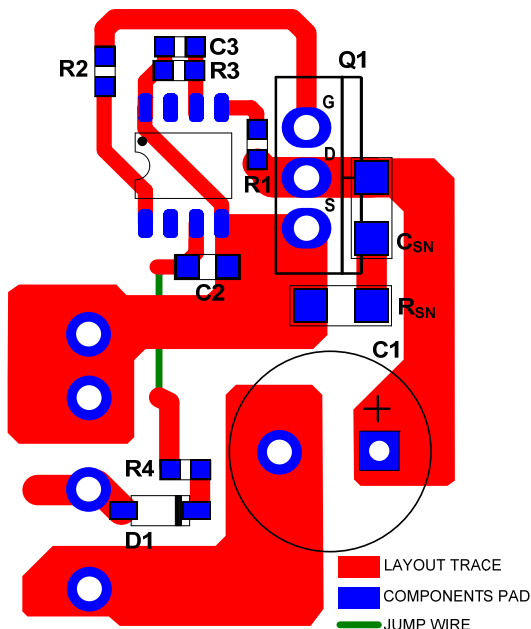

Figure 18: Layout Example with TO220 package SR FET

Figure 18 shows a layout example of a single layer with a through-hole transformer and a TO220 package SR FET. R_{SN} and C_{SN} are the RC snubber network for the SR FET.

The sensing loop (V_D and V_{SS} to the SR FET) is minimized and kept separate from the power loop. The VDD decoupling capacitor (C_4) is placed beside VDD.

Figure 19 shows another layout example of a single layer with a PowerPAK/SO8 package SR FET, which also has a minimized sensing loop and power loop to avoid the loops interfering with one another.

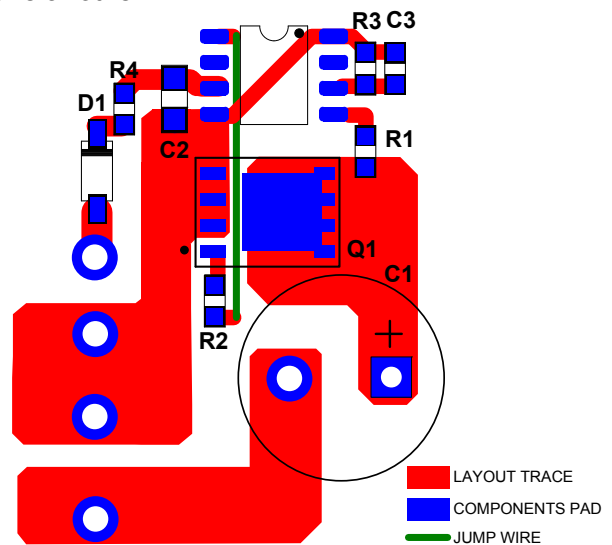

Figure 19: Layout Example with PowerPAK/SO8 Package SR FET

TYPICAL APPLICATION CIRCUIT

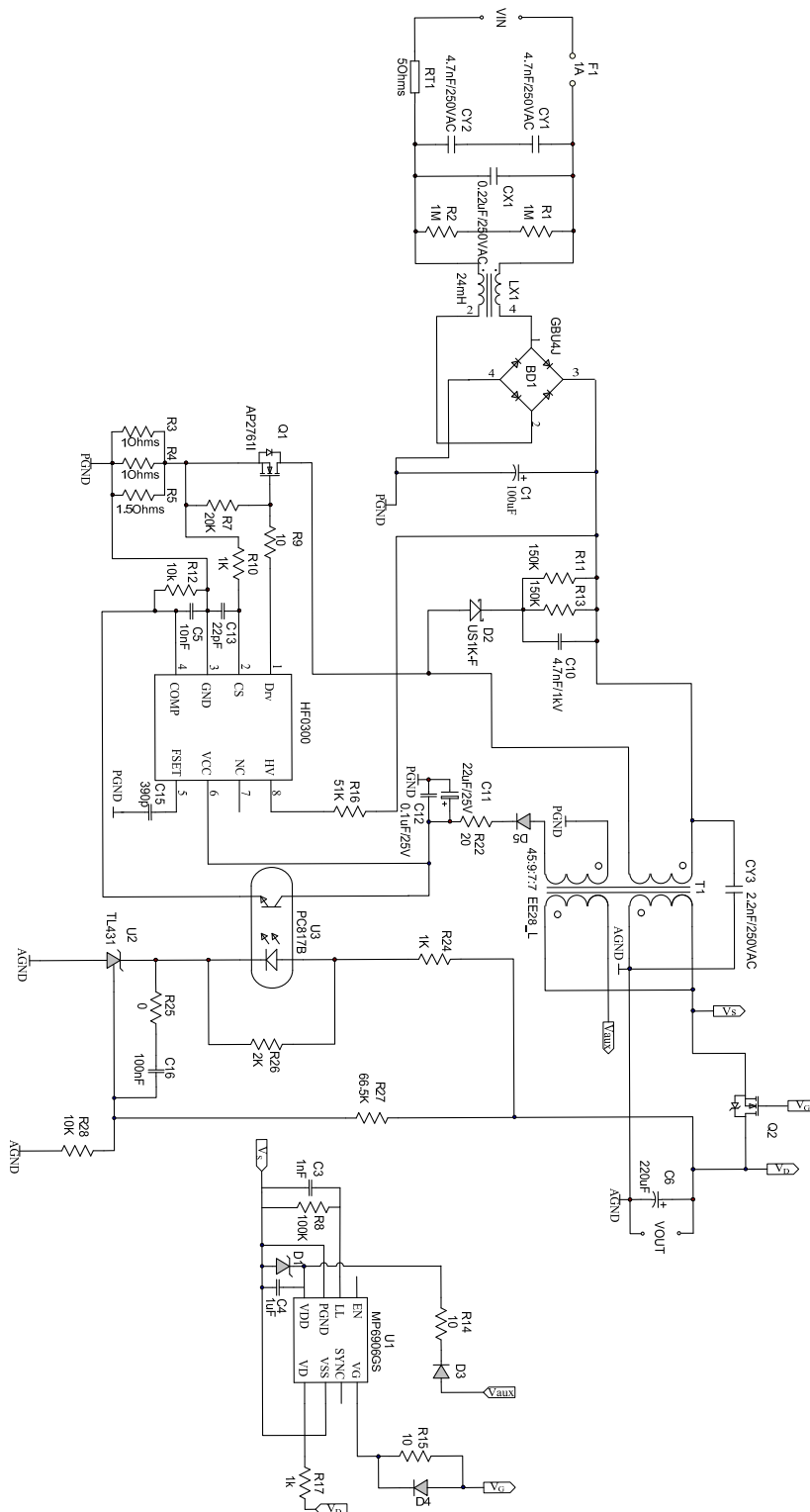
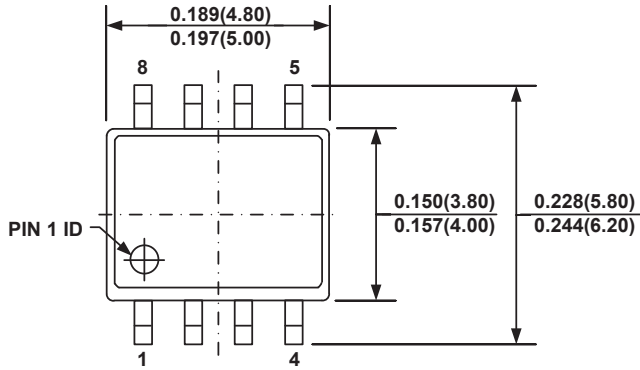

Figure 20: MP6906 for a Secondary Synchronous Controller in a 90W Flyback Application

PACKAGE INFORMATION

SOIC-8



TOP VIEW

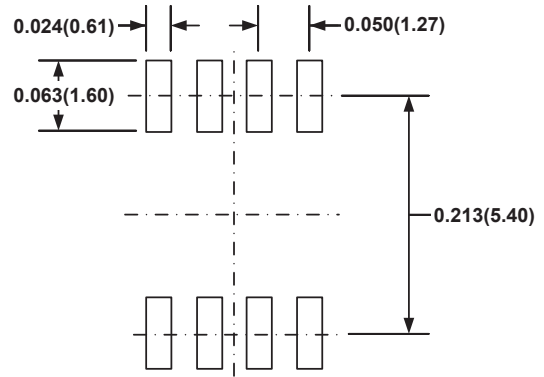

RECOMMENDED LAND PATTERN

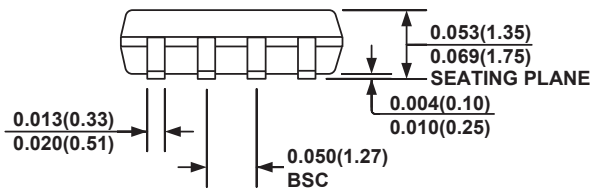

FRONT VIEW

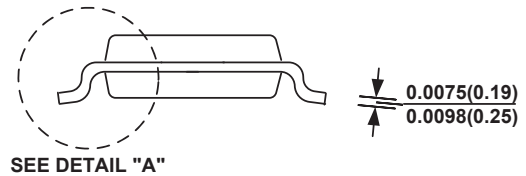

SIDE VIEW

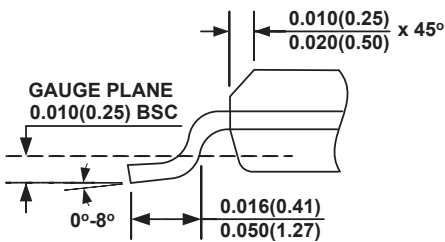

DETAIL "A"

NOTE:

- 1) CONTROL DIMENSION IS IN INCHES. DIMENSION IN BRACKET IS IN MILLIMETERS.
- 2) PACKAGE LENGTH DOES NOT INCLUDE MOLD FLASH, PROTRUSIONS OR GATE BURRS.
- 3) PACKAGE WIDTH DOES NOT INCLUDE INTERLEAD FLASH OR PROTRUSIONS.
- 4) LEAD COPLANARITY (BOTTOM OF LEADS AFTER FORMING) SHALL BE 0.004" INCHES MAX.
- 5) DRAWING CONFORMS TO JEDEC MS-012, VARIATION AA.
- 6) DRAWING IS NOT TO SCALE.